



DEUTSCH

BRANCHE CONNECTEURS AEROMILITAIRES



***DMC-MD series*** Normes EN 4165 Standard

*User Manual*

## ■ General points

This manual deals with the mounting and assembling of the DMC-M connector. It will allow you to get the best mechanical and electrical performances out of the DMC-M connector.

## ■ Presentation of the connector



- The DMC-M is a rectangular, modular connector.
- It is available in two standard sizes.
- The shells (plug and receptacle) made of aluminum alloy receive several modules equipped with removable crimped contacts size 22, 20, 16, 12 or 8 (wrapping and PCB's contacts are available too).

This modular concept allows you to design your own connector to match your own application.

The receptacles can be mounted on top of each others, but multi-receptacles are available too. The plug/receptacle coupling is done by a central clicker-nut.

The DMC-M allows 36 keying possibilities to avoid mating error in case of a stacked shells mounting.

Modules are available either in male versions or female versions. A key coding system avoid snapping a module in the wrong shell cavity. Only one type of module, with the "N" polarisation, can be snapped in any cavities.

Different modules are available ; they have the following arrangements :

- 20 contacts size 22
- 12 contacts size 20
- 08 contacts size 16
- 04 contacts size 12
- 01 contacts size 08
- Sealing module.

Shielded accessories are available. They are fully dismountable to allow an easy cabling and module insertion/extraction. Refer to the brochure for further information concerning P/N of shells and accessories

■ **Contact crimping**

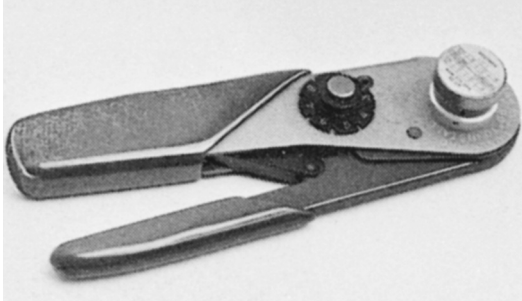

1 - Use a crimping tool

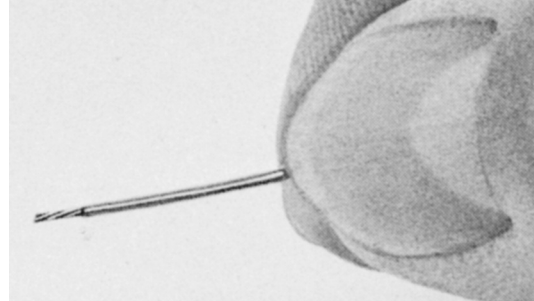

2 - Strip the wire over 5 mm maximum



3 - Insert the contact in the crimping tool

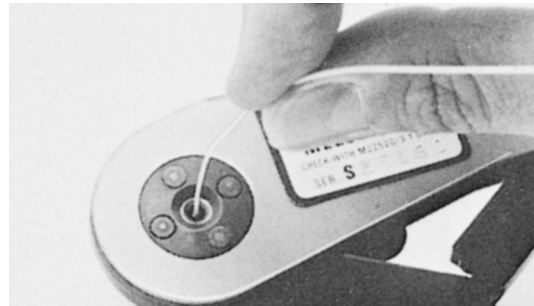

4 - Insert the wire in the contact

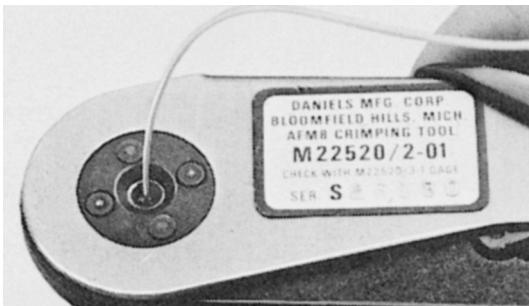

5 - Tie the crimping tool

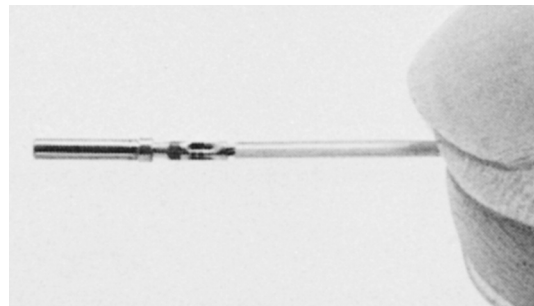

6 - Control the contact. It must have 8 markings, and the wire must be seen in the contact side hole.

*Note : If you are using a shielded version, do not forget to slide the cables in the chimney before crimping the contacts.*

**Contact insertion**

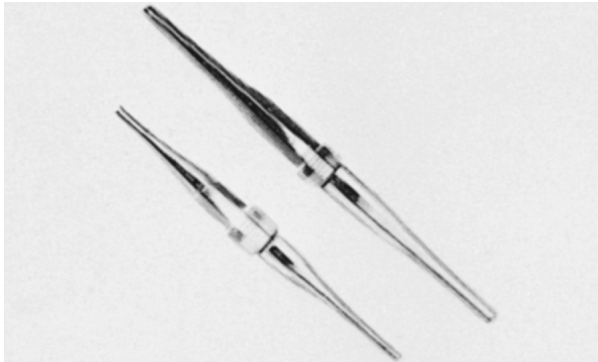

1 - Use the appropriate mounting and dismounting plastic tool. There is one tool for each contact gauge.

Tools part numbers	
M 81969/14-01	For size 22
M 15570-20	For size 20
M 15570-16	For size 16
M 15570-12	For size 12
114-008 or M 81969/14-06	For size 08

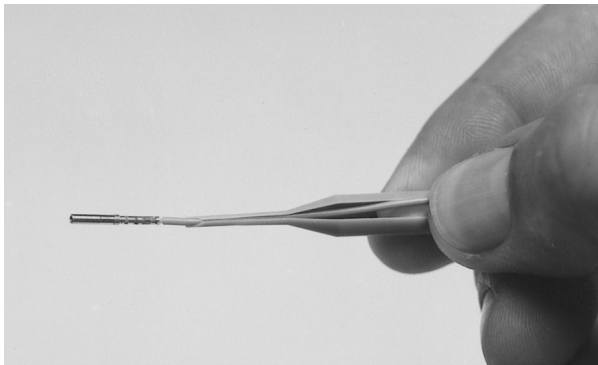

2 - Insert the wire in the slot of the colored side of the tool. Pull the wire until the contact butts against the tool.

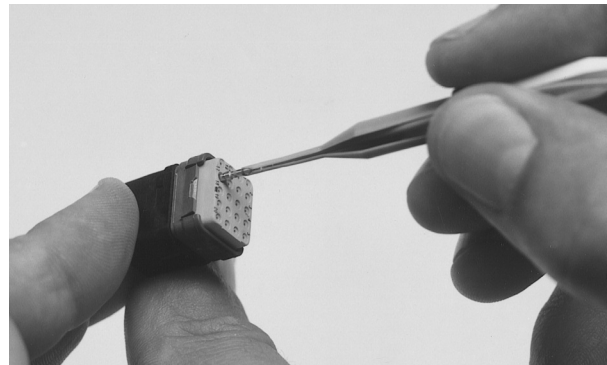

3 - Insert the contact in the corresponding module's cavity. Push the contact until butting. Then remove the tool and lightly pull the wire back to make sure that the contact is well inserted.

**Contact extraction**

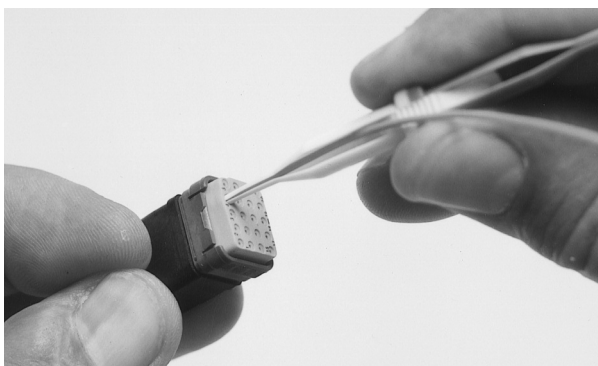

1 - Insert the wire in the slot of the tool's white side. Slide the tool into the cavity until butting.

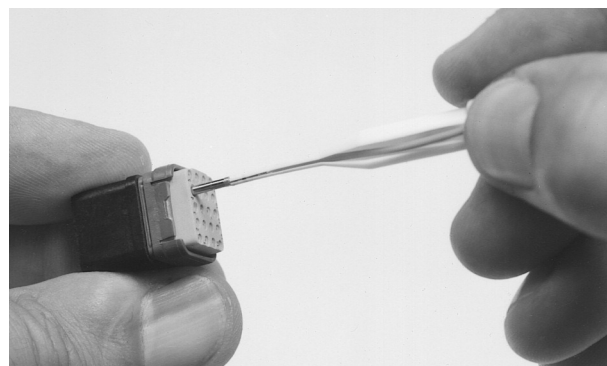

2 - Press the wire between your fingers and the tool. Then pull the overall wire and tool back.

**Arrangements**

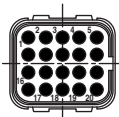

**Arrangement 20-22**  
20 contacts size 22

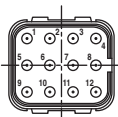

**Arrangement 12-20**  
12 contacts size 20

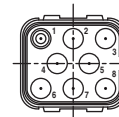

**Arrangement 08-16**  
8 contacts size 16

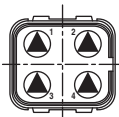

**Arrangement 04-12**  
4 contacts size 12

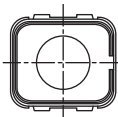

**Arrangement 01-08**  
1 contact size 8

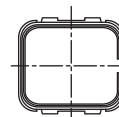

**Arrangement 00-00 P**  
Sealing module

● **Female module**

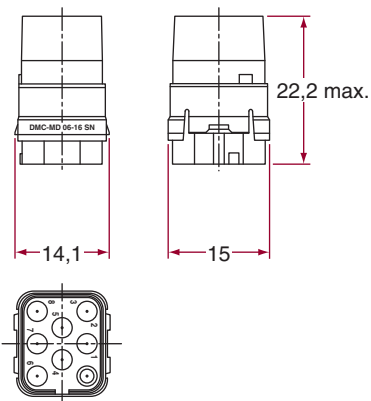

● **Male module**

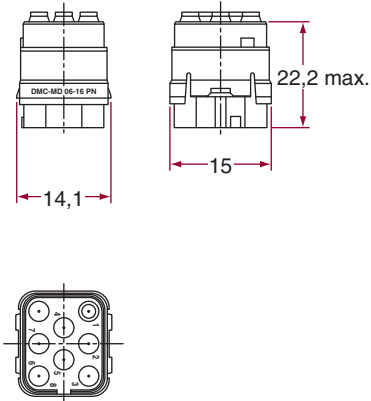

Note : Male or female modules can be either mounted in plugs or receptacles

**Polarisation**

**Polarisation N**  
Standard

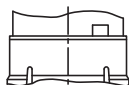

**Polarisation A**

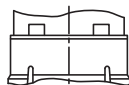

**Polarisation B**

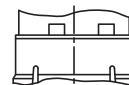

**Polarisation C**

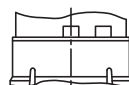

**Polarisation D**

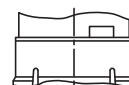

Each module can have a polarisation key **A, B, C** or **D**

Note : The polarised modules must be installed in their respective **A, B, C** or **D** shell cavity.

The modules with standard polarisation **N** can be installed in all keyway options.

**Modules snapping**

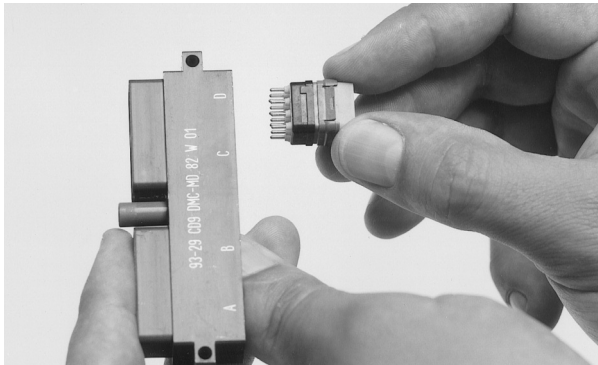

1 - The module must be inserted from the rear side of the shell. The polarisation key must be visible from the marked side of the shell.

Make sure that the module is well inserted either by pulling back the wires (if wired) or by pushing the module from the front of the shell.

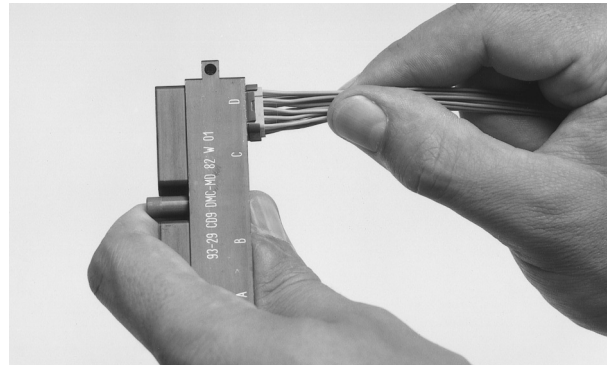

2 - Push manually the module (wired or not) until butting. **For sealed modules use the insertion tool P/N 057-0699-00 A.**

**Removing the modules**



1 - Use the extraction tool P/N 057-0289-00 A.

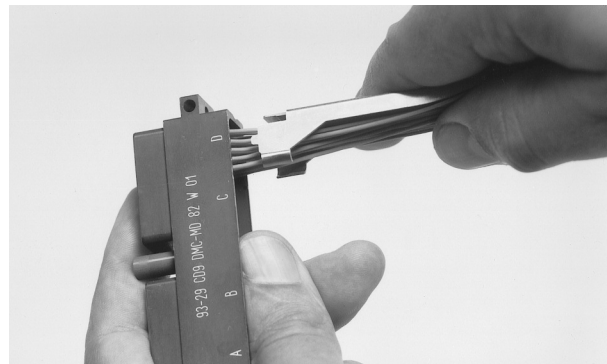

2 - Slide the tool around the cable. Then push the tool inside the shell until butting.

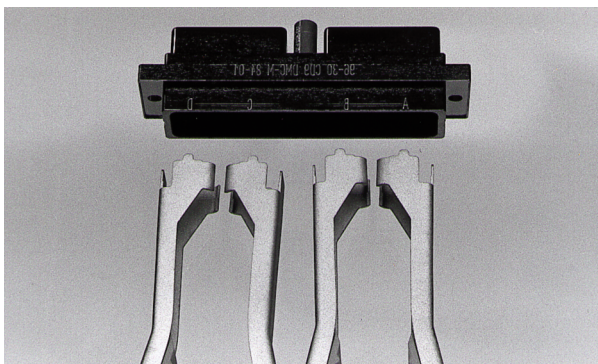

3 - Note the different tool's position depending on the A, B, C or D cavities.

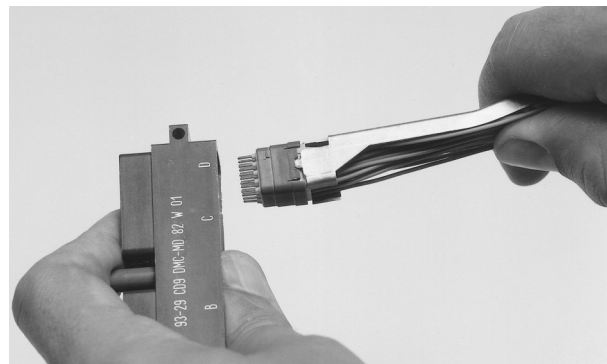

4 - Press the cable between the tool and your fingers and pull the overall back.

Note : If the module is not wired, use the same tool, but push the module from the front of the shell.

DMC-M connectors are supplied with a coupling mechanism allowing 36 clocking possibilities. (Six different keys times six different key positioning).

**Receptacle coupling key - TYPE 732-8021-\*\*B**

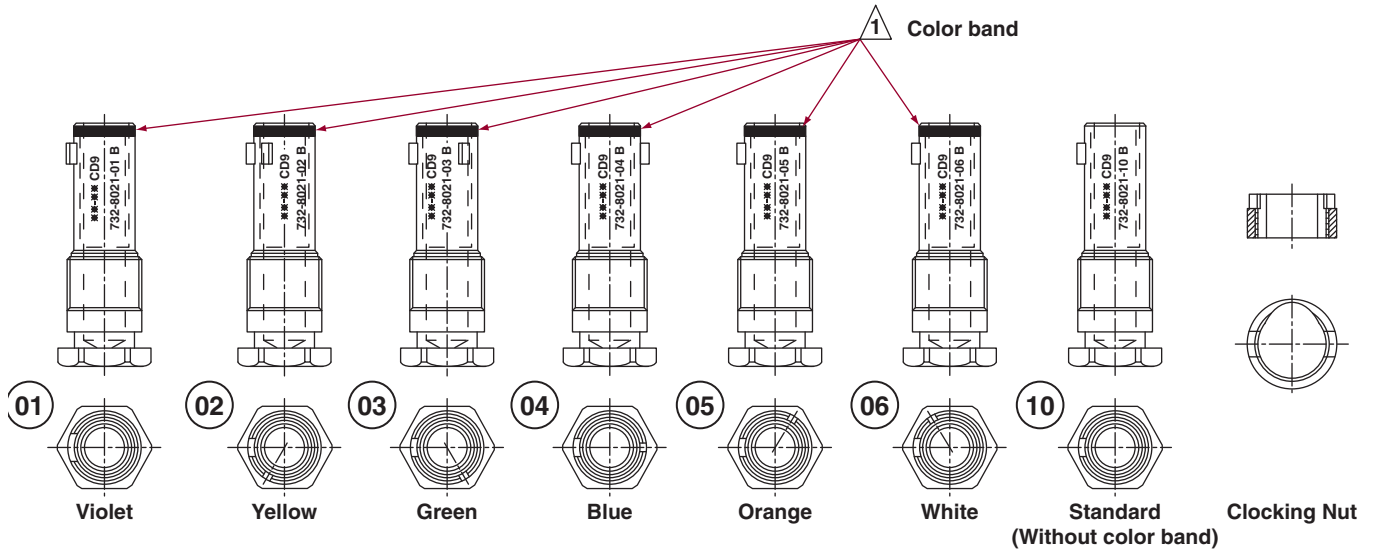

Mounting the receptacle coupling key requires the use of a spanner ref. 057-0590-80. It is supplied with a lock nut and can be removed.

**Plug coupling key - TYPE 732-8020-\*\***

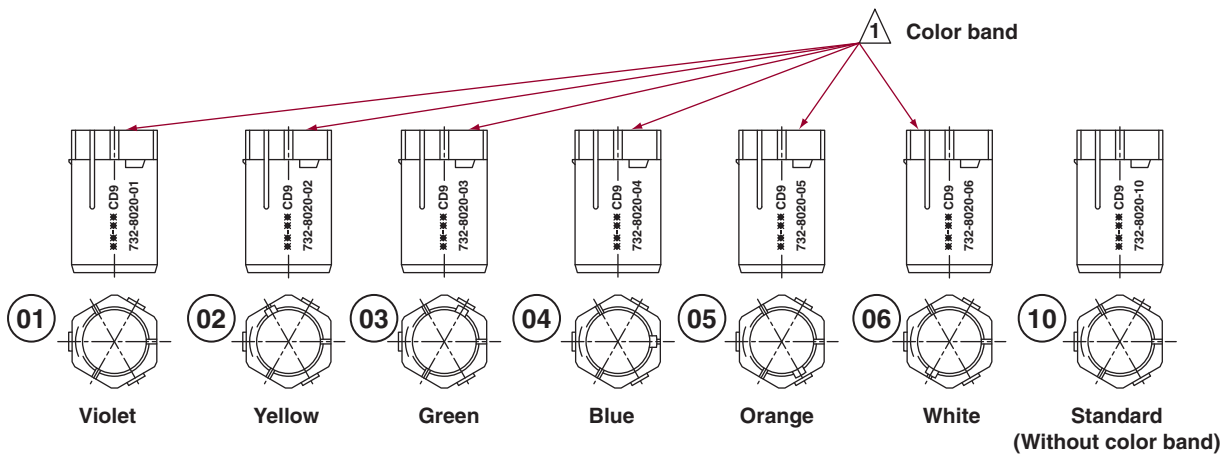

Mounting these keys does not require the use of a tool.

Note : They must be changed when removed.

**■ Plug's coupling key mounting**

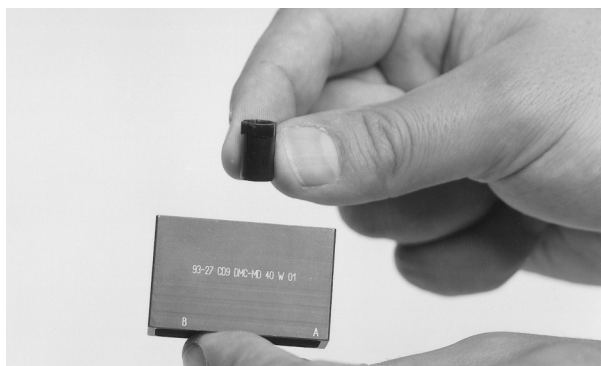

1 - Use a plug's coupling key corresponding to the receptacle's coupling key (same color code).

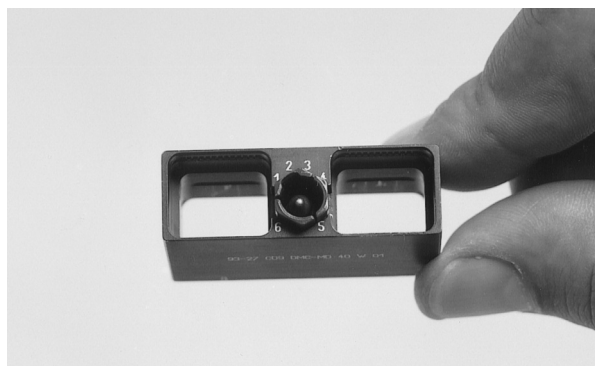

2 - Insert the plug's coupling key in the front side of the plug, and make sure that the position of the key (6 possibilities) allows the insertion of the receptacle's key. Then fix the plug's key manually by pushing it down to the bottom of its cavity.

**■ Receptacle's coupling key mounting**

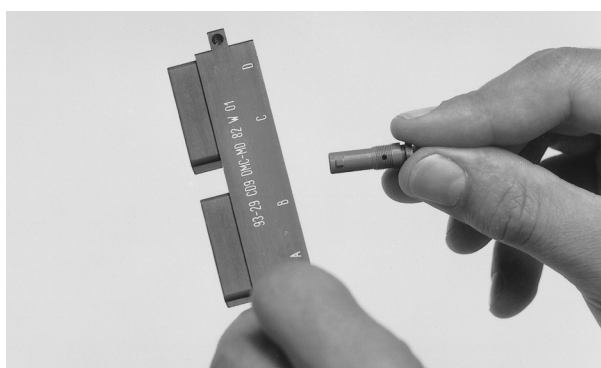

1 - The coupling key must be inserted by the rear side of the receptacle. Position it as desired (position 1, 2, 3, 4, 5 or 6).

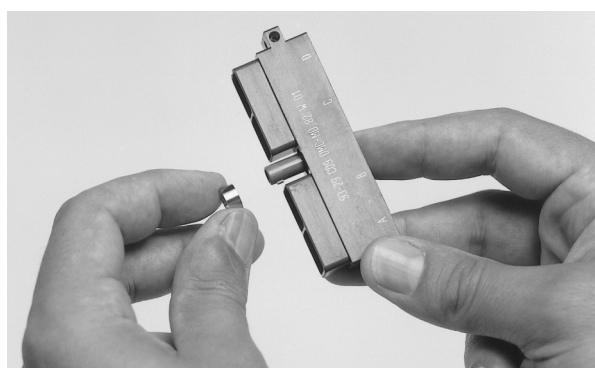

2 - Fixe it with the corresponding nut.

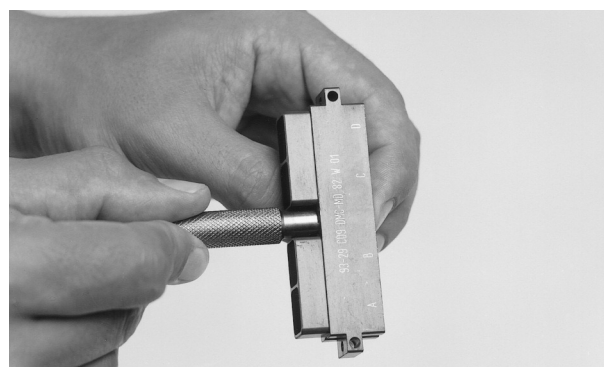

3 - Tie the nut with the tool P/N 057-0590-80 by applying a  $0,15 \pm 0,02$  daN.m torque.

**■ Plug/receptacle coupling**

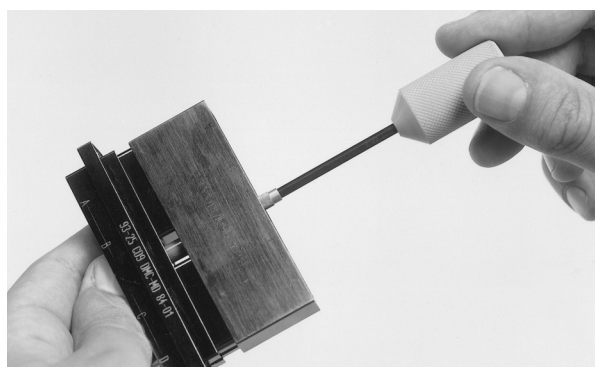

Use the tool P/N 057-0592-80 and apply a  $0,1 \pm 0,03$  daN.m tightening torque.



**Shielded braid mounting on chimneys**

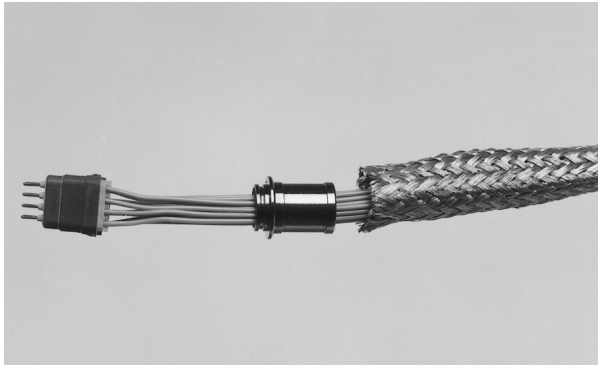

1 - Slide the chimney and the shielded braid around the cable.



2 - Slide the shielded braid over the chimney as well as the 3 mm "band it" ring.

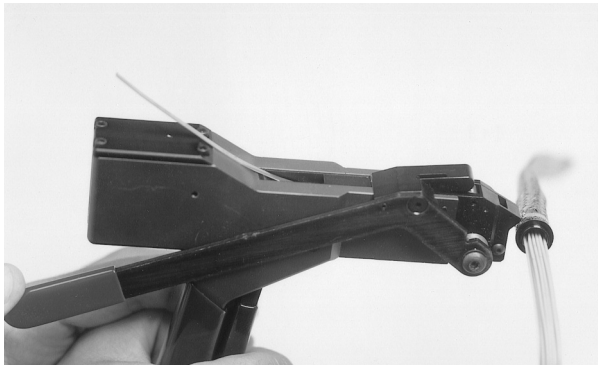

3 - Use the tool P/N 057-0450-00 to tie the ring around the shielded braid over the chimney.

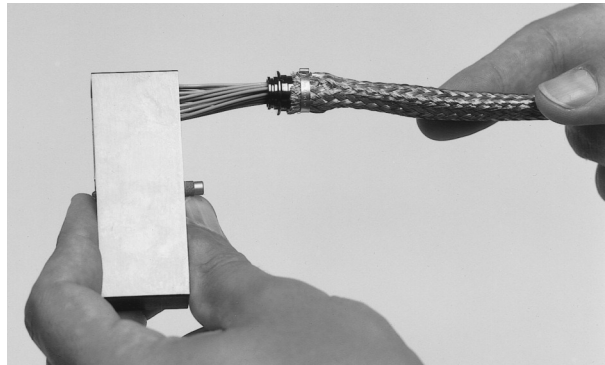

4 - Snap the module(s) in the shell.

**Shielded accessories mounting**

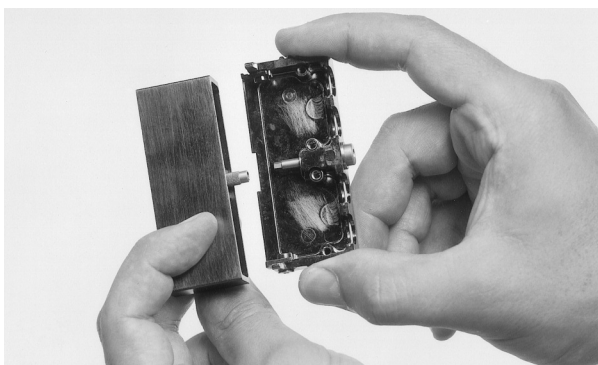

1 - Choose the appropriate plug or receptacle accessory. Insert the accessory in the shell. Make sure that the marking of the accessory ( $A_2$ ,  $b_2$ , ...) is in front of the respective shell's cavities (A, B, ...).

The accessory's screw of the plug's accessory must be coupled to the shell's nut of the plug to allow the receptacle/plug coupling.

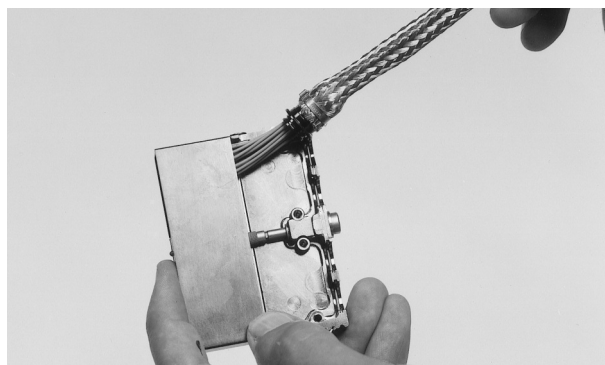

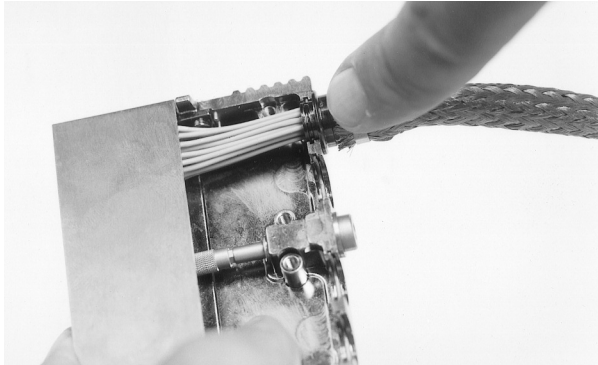

2 - Insert the chimneys in their respective cavities.

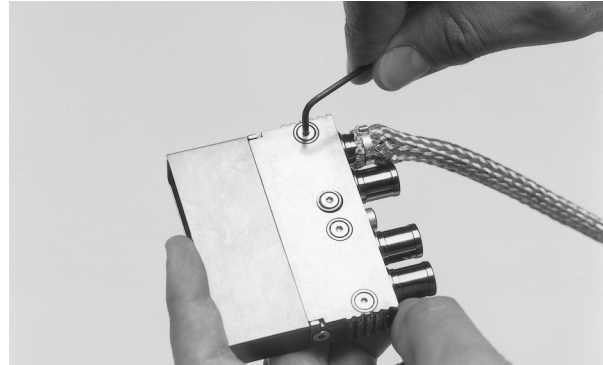

3 - Place the accessory's cover, and tie the overall screws by applying a 0,05 <sup>+0,02</sup> daN.m torque.

### **Rack and panel plug mounting**

The rack plugs are designed to allow a misalignment of  $\pm 0,75$  mm maximum on the X and Y axis, and a compression of a 4 mm maximum on the Z axis.

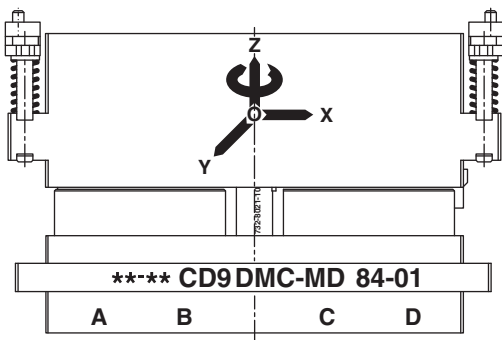

Misalignment max between Rack and Panel to Receptacle

OZ :  $\pm 2$  mm

OX :  $\pm 0,75$  mm

OY :  $\pm 0,75$  mm

$\theta$  :  $\pm 1^\circ$

To get the right sealing between the plug and the receptacle press the plug's spring by 1 mm at least (4 mm maximum). Therefore, the distance between both panels, must be either A less 1 mm at least, or B less 1 mm at least (less the panel thickness).

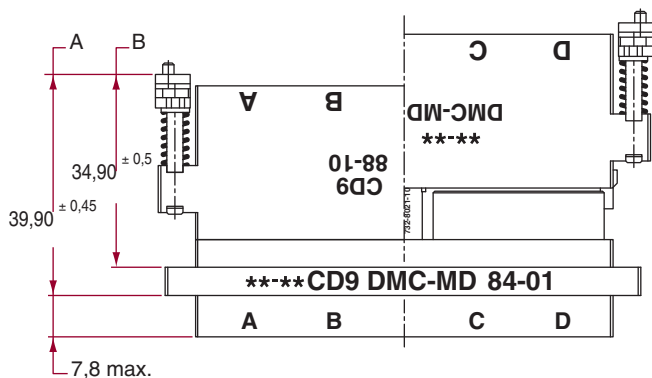

**DMC-M 88** with receptacle **82** or **84**  
**DMC-MD 48** with receptacle **42** or **44**

The receptacle must be equipped with the appropriate coupling nut (P/N 732-8021-\*\*\*B) to guaranty a centering of the plug when coupling. However, it will not avoid damaging contacts and modules when coupling a heavy rack unprecisely centered.

The compression force is 15 daN for 1 mm.  
 18 daN for 2 mm.  
 21 daN for 3 mm.  
 24 daN for 4 mm.

Utilize M3 type of screws (not supplied with the connector).  
Coupling torque for panel screw 0,2 daN.m max.

■ **For plug rack and panel - TYPES 88 – 48**

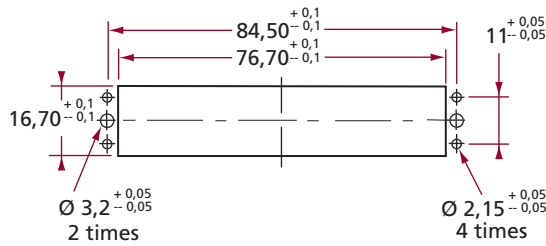

**TYPE 88**

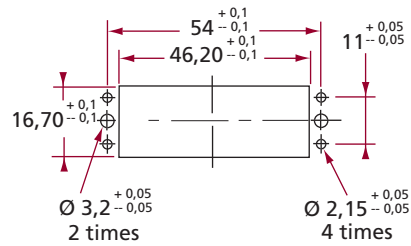

**TYPE 48**

■ **For receptacle - TYPES 82/84 and 42/44**

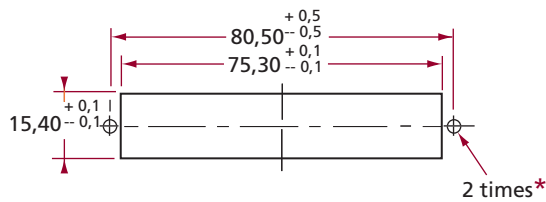

**TYPE 82 AND 84**

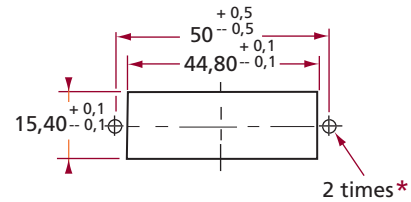

**TYPE 42 AND 44**

\* M3 : Direct fixation on panel  
Ø 3,2 : M3 screw and nut fixation

- Receptacle coupling key mounting tool - 057-0590-80

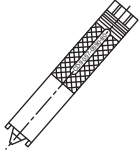

- Coupling tool - 057-0592-80



- Module extraction tool - 057-0289-00 **A** / 057-0289-00 **B**

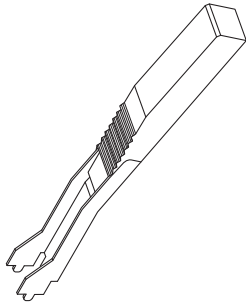

- Module insertion tool - 057-0699-00 **A** / 057-0699-00 **B**

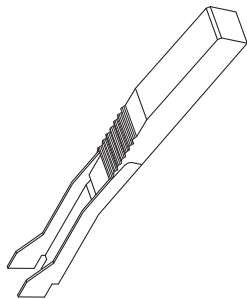

**A** : Long version = 143 mm

**B** : Short version = 113 mm

For set-up kit tool, consult us.





CONNECTEURS ELECTRIQUES DEUTSCH

17, rue Lavoisier z.i. n° 2 B.P. 117 27091 EVREUX CEDEX 09 (FRANCE) - Tél.: +33 (0)2 32 23 57 00 - Fax : +33 (0)2 32 23 58 00  
E-mail : [ced@deutsch.net](mailto:ced@deutsch.net) - Web : [www.deutsch.net](http://www.deutsch.net) - Réf.: CC 744-22 A Edition Mars 2008