

**VOIDLESS - HERMETICALLY- SEALED
 ULTRAFAST RECOVERY GLASS RECTIFIERS**
Qualified per MIL-PRF-19500/477

DEVICES

Leaded	1N5807	1N5809	1N5811
Surface Mount	1N5807US	1N5809US	1N5811US
	1N5807URS	1N5809URS	1N5811URS

LEVELS

JAN
JANTX
JANTXV
JANS

DESCRIPTION

This “Ultrafast Recovery” rectifier diode series is military qualified to MIL-PRF-19500/477 and is ideal for high-reliability applications where a failure cannot be tolerated. These industry-recognized 6.0 Amp rated rectifiers for working peak reverse voltages from 50 to 150 volts are hermetically sealed with voidless-glass construction using an internal “Category I” metallurgical bond. These devices are available in both leaded and surface mount MELF package configurations. Microsemi also offers numerous other rectifier products to meet higher and lower current ratings with various recovery time speed requirements including standard, fast and ultrafast device types in both through-hole and surface mount packages.

IMPORTANT: For the most current data, consult MICROSEMI’s website: <http://www.microsemi.com>

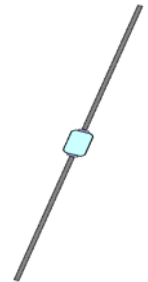

**B-Body
 Leaded Package**

FEATURES

- Popular JEDEC registered 1N5807, 1N5809, 1N5811
- Voidless hermetically sealed glass package
- Extremely robust construction
- Internal “Category I” Metallurgical bonds
- JAN, JANTX, JANTXV, and JANS available per MIL-PRF-19500/477
- Surface mount versions available in a square end-cap MELF configuration with “US” suffix

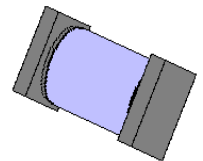

**B-Body
 Surface Mount
 MELF PACKAGE**

APPLICATIONS / BENEFITS

- Ultrafast recovery 6 Amp rectifier series 50 to 150V
- Military Space and other high-reliability applications
- Switching power supplies or other applications requiring extremely fast switching & low forward loss
- High forward surge current capability
- Low thermal resistance
- Controlled avalanche with peak reverse power capability
- Inherently radiation hard as described in Microsemi MicroNote 050

MAXIMUM RATINGS

- Junction Temperature: -65°C to $+175^{\circ}\text{C}$
- Storage Temperature: -65°C to $+175^{\circ}\text{C}$
- Average Rectified Forward Current (I_{O}): 6 A @ $T_{\text{L}} = 75^{\circ}\text{C}$ at 3/8 inch lead length (see note 1)
- Thermal Resistance: 22 $^{\circ}\text{C}/\text{W}$ junction to lead (L=.375 in)
- Thermal Impedance: 1.5 $^{\circ}\text{C}/\text{W}$ @ 10 ms heating time
- Forward Surge Current (8.3 ms half sine) 125 Amps
- Capacitance: 60 pF at 10 volts, $f = 1$ MHz
- Solder temperature: 260°C for 10 s (maximum)

MECHANICAL AND PACKAGING

- CASE: Hermetically sealed voidless hard glass with Tungsten slugs
- TERMINATIONS: Axial-leads are Tin/Lead (Sn/Pb) over Ni plate over Copper.
- MARKING: Body painted and part number, etc.
- POLARITY: Cathode indicated by band
- Tape & Reel option: Standard per EIA-296
- Weight: 750 mg
- See package dimensions on last page

ELECTRICAL CHARACTERISTICS @ $T_A = 25^\circ\text{C}$

TYPE	WORKING PEAK REVERSE VOLTAGE V_{RWM}	BREAKDOWN VOLTAGE (MIN.) @ 100 μA V_{BR}	AVERAGE RECTIFIED CURRENT I_{O1} @ $T_L=75^\circ\text{C}$ (Note 1)	AVERAGE RECTIFIED CURRENT I_{O2} @ $T_A=-65^\circ\text{C}$ Note 2	MAXIMUM FORWARD VOLTAGE @ 4A (8.3 ms pulse) V_F		REVERSE CURRENT (MAX) @ V_{RWM} I_R		SURGE CURRENT (MAX) I_{FSM} (NOTE 3)	REVERSE RECOVERY TIME (MAX) (NOTE 4) t_{rr}
	VOLTS	VOLTS	AMPS		VOLTS		μA		AMPS	ns
					25 $^\circ\text{C}$	125 $^\circ\text{C}$	25 $^\circ\text{C}$	125 $^\circ\text{C}$		
1N5807, US, URS	50	60	6.0	3.0	0.875	0.800	5	525	125	30
1N5809, US, URS	100	110	6.0	3.0	0.875	0.800	5	525	125	30
1N5811, US, URS	150	160	6.0	3.0	0.875	0.800	5	525	125	30

NOTE 1: Leaded: Rated at $T_L = 75^\circ\text{C}$ at 3/8 inch lead length. Derate at 60 mA/ $^\circ\text{C}$ for T_L above 75°C .
 Surface mount: Rated at $T_{EC} = 75^\circ\text{C}$. Derate at 60 mA/ $^\circ\text{C}$ for T_{EC} above 75°C .

NOTE 2: Derate linearly at 25 mA/ $^\circ\text{C}$ above $T_A = 55^\circ\text{C}$. This rating is typical for PC boards where thermal resistance from mounting point to ambient is sufficiently controlled where $T_{J(max)}$ does not exceed 175°C

NOTE 3: $T_A = 25^\circ\text{C}$ @ $I_O = 3.0\text{ A}$ and V_{RWM} for ten 8.3 ms surges at 1 minute intervals

NOTE 4: $I_F = 1.0\text{ A}$, $I_{RM} = 1.0\text{ A}$, $I_{R(REC)} = 0.10\text{ A}$ and $di/dt = 100\text{ A}/\mu\text{s min}$

SYMBOLS & DEFINITIONS

Symbol	Definition
V_{BR}	Minimum Breakdown Voltage: The minimum voltage the device will exhibit at a specified current.
V_{RWM}	Working Peak Reverse Voltage: The maximum peak voltage that can be applied over the operating temperature range.
V_F	Maximum Forward Voltage: The maximum forward voltage the device will exhibit at a specified current.
I_R	Maximum Leakage Current: The maximum leakage current that will flow at the specified voltage and temperature.
C	Capacitance: The capacitance in pF at a frequency of 1 MHz and specified voltage
t_{rr}	Reverse Recovery Time: The time interval between the instant the current passes through zero when changing from the forward direction to the reverse direction and a specified recovery decay point after a peak reverse current is reached.

GRAPHS

FIGURE 1
 TYPICAL FORWARD CURRENT vs. FORWARD VOLTAGE

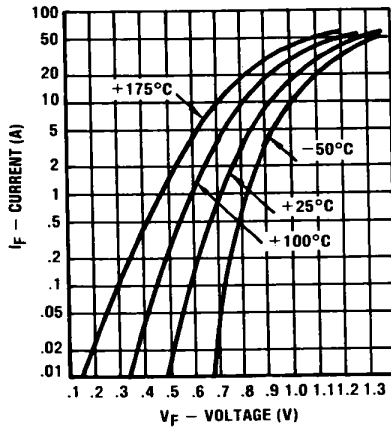

FIGURE 2
 TYPICAL REVERSE CURRENT vs. VOLTAGE

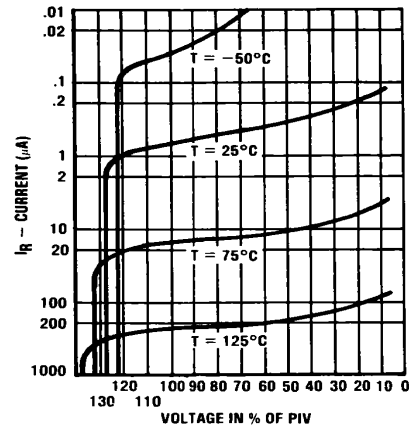

FIGURE 3
 OUTPUT CURRENT vs. LEAD TEMPERATURE

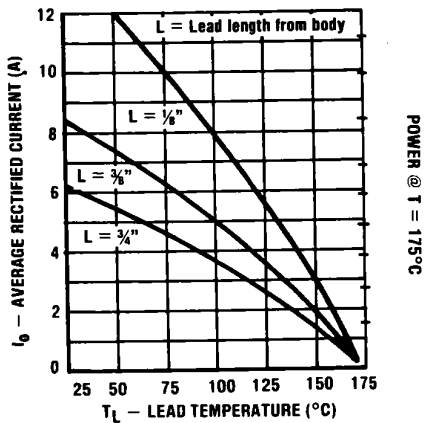

FIGURE 4
 FORWARD PULSE CURRENT vs. DURATION

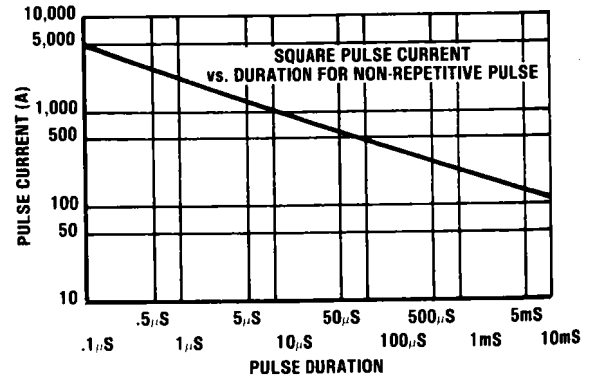
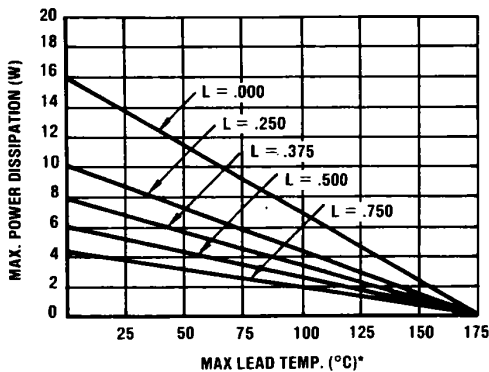
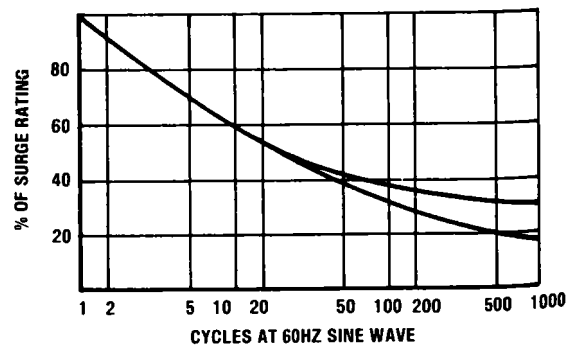

FIGURE 6
 MAXIMUM LEAD TEMP. vs. PD



*Maximum lead temp. in °C (T_L) at point "L" from body.
 (For max. operating junction temp. of 175°C with equal two-lead conditions.)

FIGURE 7
 MULTIPLE SURGE CURRENT vs. DURATION



PACKAGE DIMENSIONS

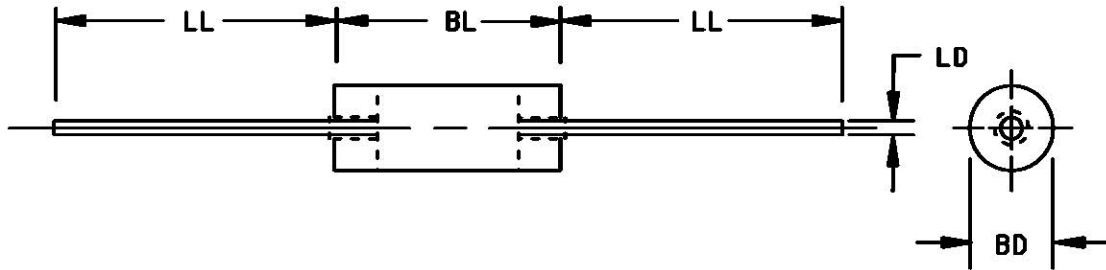

Ltr	Dimensions				Notes
	1N5807, 1N5809, 1N5811				
	Inches		Millimeters		
	Min	Max	Min	Max	
BD	.115	.142	2.92	3.61	4
BL	.130	.300	3.30	7.62	3
LD	.036	.042	0.91	1.07	3
LL	.900	1.30	22.86	33.02	

NOTE:

1. Dimensions are in inches.
2. Millimeters are given for general information only.
3. Dimension BL shall include the entire body including slugs and sections of the lead over which the diameter is uncontrolled. This uncontrolled area is defined as the zone between the edge of the diode body and extending .050 inch (1.27 mm) onto the leads.
4. Dimension BD shall be measured at the largest diameter.
5. In accordance with ASME Y14.5M, diameters are equivalent to ϕx symbology.

Lead Tolerance = + .002 -.003 in

*Includes sections of the lead or fillet over which the lead diameter is uncontrolled.

FIGURE 1. Physical Dimensions

PACKAGE DIMENSIONS

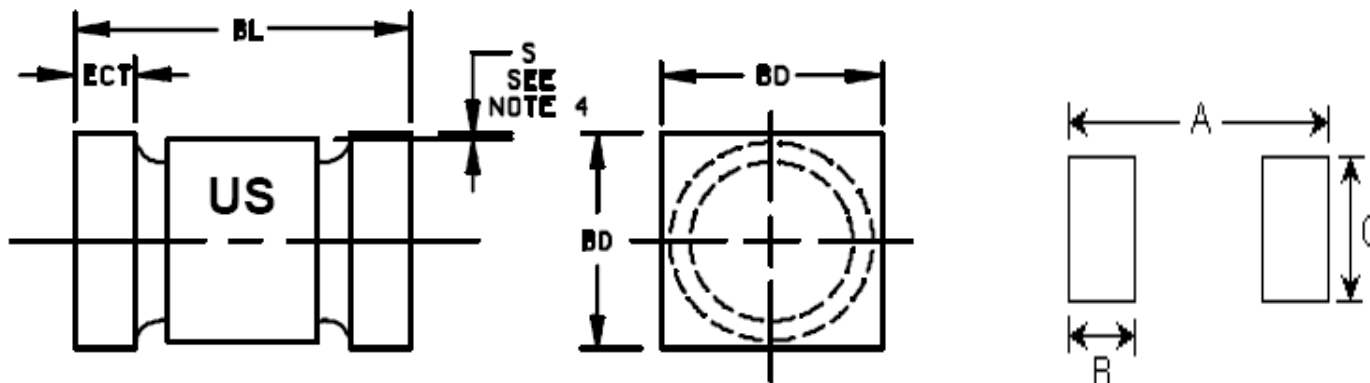

Ltr	Dimensions				Notes
	1N5807US, 1N5809US, 1N5811US				
	Inches		Millimeters		
	Min	Max	Min	Max	
BD	.137	.148	3.84	3.76	
BL	.200	.225	5.08	5.72	
ECT	.019	.028	0.48	0.71	
S	.003		0.08		

PAD LAYOUT

	INCHES	mm
A	0.288	7.32
B	0.070	1.78
C	0.155	3.94

Note: If mounting requires adhesive separate from the solder, an additional 0.080 inch diameter contact may be placed in the center between the pads as an optional spot for cement.

NOTE 1:

1. Dimensions are in inches.
2. Millimeters are given for general information only.
3. Dimensions are pre-solder dip.
4. Minimum clearance of glass body to mounting surface on all orientations.
5. Cathode marking to be either in color band, three dots spaced equally, or a color dot on the face of the end tab.
6. Color dots will be .020 inch (0.51 mm) diameter minimum and those on the face of the end tab shall not lie within .020 inch (0.51 mm) of the mounting surface.
7. In accordance with ASME Y14.5M, diameters are equivalent to ϕ x symbology.

NOTE 2: This Package Outline has also previously been identified as “D-5B”

FIGURE 2A. Physical dimensions of US surface mount family

PACKAGE DIMENSIONS

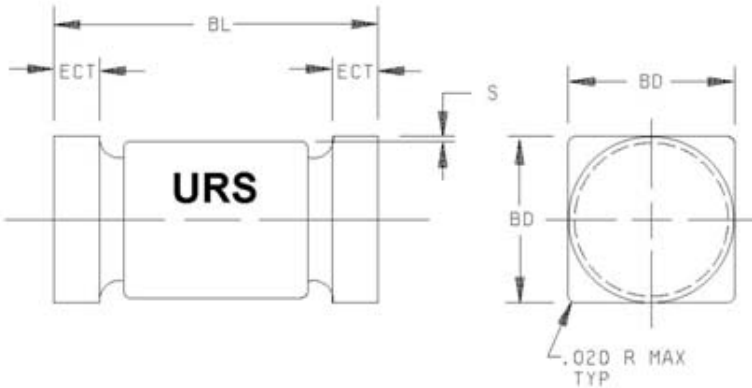

Ltr	Dimensions				Notes
	1N5802URS, 1N5804URS, 1N5806URS				
	Inches		Millimeters		
	Min	Max	Min	Max	8
BD	.091	.103	2.31	2.62	
BL	.168	.200	4.27	5.08	
ECT	.019	.028	0.48	0.71	8
S	.003		0.08		

NOTES:

1. Dimensions are in inches.
2. Millimeters are given for general information only.
3. Dimensions are pre-solder dip.
4. Minimum clearance of glass body to mounting surface on all orientations.
5. Cathode marking to be either in color band, three dots spaced equally, or a color dot on the face of the end tab.
6. Color dots will be .020 inch (0.51 mm) diameter minimum and those on the face of the end tab shall not lie within .020 inch (0.51 mm) of the mounting surface.
7. In accordance with ASME Y14.5M, diameters are equivalent to ϕx symbology.
8. One endcap shall be square and the other endcap shall be round.

FIGURE 2B. Physical dimensions of URS surface mount family.