

**MT2 Relay**

- Telecom/signal relay (dry circuit, test access, ringing)
- Slim line 20x10mm (.795x.393")
- Switching current 2A
- 2 form C contacts (2 CO, 2 changeover contacts)
- Bifurcated contacts
- Meets FCC Part 68 and ITU-T K20

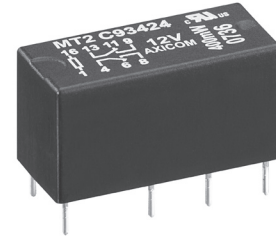

Typical applications

Communications equipment, linecard application – analog, ISDN, xDSL, PABX, voice over IP, office and business equipment, measurement and control equipment, consumer electronics, set top boxes, HiFi, medical equipment, automotive Equipment

**Approvals**

UL 508 File No. E 111441  
Technical data of approved types on request

**Contact Data**

Contact arrangement	2 form C (2 CO)
Max. switching voltage	220VDC, 250VAC
Rated current	2A
Limiting continuous current, 85°C	2A
Contact material	AgNi, gold-covered
Contact style	bifurcated contacts
Min. recommended contact load	10mA at 20mV
Minimum switching voltage	100µV
Initial contact resistance	< 70mΩ at 10mA, 20mV
Frequency of operation, without load max.	50 operations/s
Operate / release time max.	5ms/3ms
Bounce time max.	5ms
Electrical endurance	
contact application 0 (≤30mV/≤10mA)	min. 5x10 <sup>6</sup> operations
cable load open end	min. 2.5x10 <sup>6</sup> operations
resistive load 150V/0.2A - 30W	min. 2x10 <sup>5</sup> operations
24V/1.25A - 30W	min. 2x10 <sup>5</sup> operations
Contact ratings, UL	220VDC/0.24A - 60W 125VDC/0.24A - 30W 250VAC/0.25A - 62.5VA 125VAC/0.5A - 62.5VA 30VDC/2A - 60W
Mechanical endurance	typ. 100x10 <sup>6</sup> operations

**Coil Data**

Magnetic system	neutral
Coil voltage range	3 to 48VDC
Max. coil temperature	115°C
Thermal resistance	< 85K/W

**Coil versions, monostable**

Coil code	Rated voltage VDC	Operate voltage VDC <sub>min.</sub>	Limiting Voltage VDC <sub>max.</sub>	Release voltage VDC <sub>min.</sub>	Coil resistance Ω±10%	Rated coil power mW
<b>High sensitive version, 150mW</b>						
00	3	2.1	8.1	0.3	60	150
07	3.3	2.3	8.8	0.33	72	150
06	4.5	3.2	12.2	0.45	136	150
01	5	3.6	13.5	0.5	168	150
27	6	4.3	16.2	0.6	240	150
05	9	6.4	24.3	0.9	544	150
02	12	8.6	32.4	1.2	968	150
03	24	17.1	64.8	2.4	3872	150
04	48	34.1	129.6	4.8	15468	150
<b>Sensitive version, 200mW</b>						
14	3	2	7	0.3	45	200
15	4.5	2.9	10.5	0.45	101	200
16	5	3.3	11.6	0.5	125	200
28	6	3.9	14	0.6	180	200
17	9	5.9	21	0.9	405	200
18	12	7.8	28	1.2	720	200
19	24	15.6	59.9	2.4	2880	200
20	48	31.2	112	4.8	11520	200
<b>Sensitive version, 300mW</b>						
33	4.5	3.1	8.9	0.45	73	300
34	5	3.4	9.9	0.5	90	300
12	12	8.25	23.6	1.2	515	300
35	24	16.5	47.3	2.4	2060	300
36	48	32.5	54.6	4.8	8240	300
<b>Standard version, 400mW</b>						
21	4.5	2.9	8.9	0.45	50	400
22	5	3.3	9.9	0.5	63	400
29	6	3.9	11.8	0.6	90	400
23	9	5.9	17.7	0.9	203	400
24	12	7.8	23.6	1.2	360	400
25	24	15.6	47.3	2.4	1440	400
26	48	31.2	94.6	4.8	5760	400
<b>Standard version, 550mW</b>						
38	4.5	2.9	6.3	0.45	36	550
50	5	3.3	7	0.5	45	550
37	6	3.9	8.4	0.6	66	550
32	12	7.8	16.8	1.2	280	550
31	24	15.6	33.6	2.4	1050	550
30	48	31.2	67.2	4.8	4100	550

All figures are given for coil without pre-energization, at ambient temperature +23°C. Other coil voltages on request.

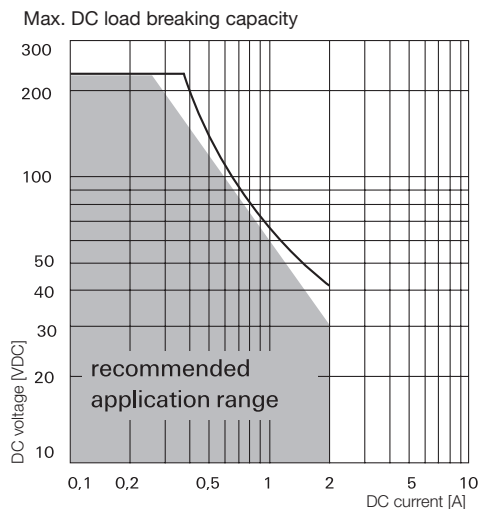

MT2 Relay (Continued)

Coil Data (continued)

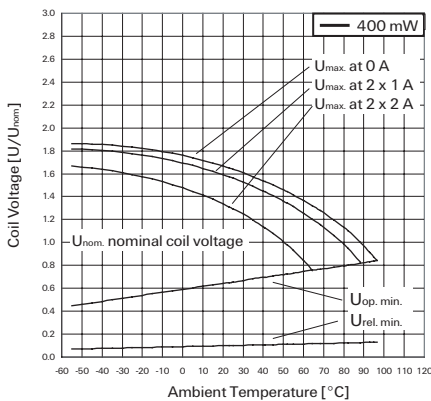
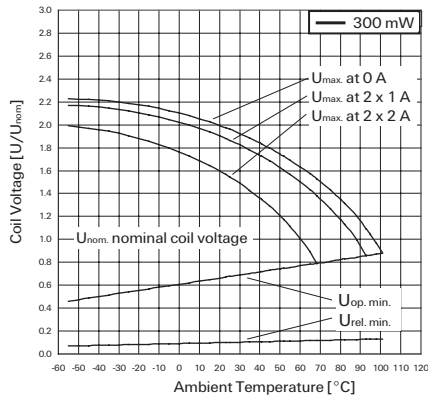
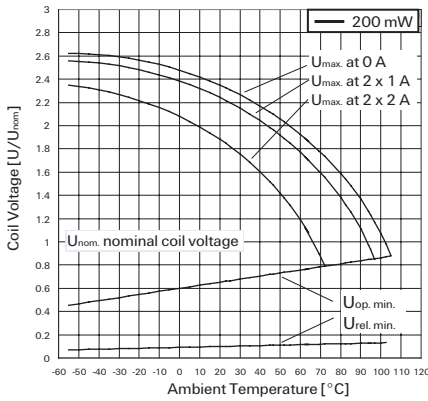
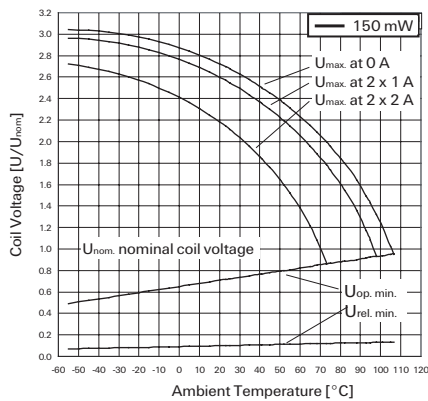

Coil Data (continued)

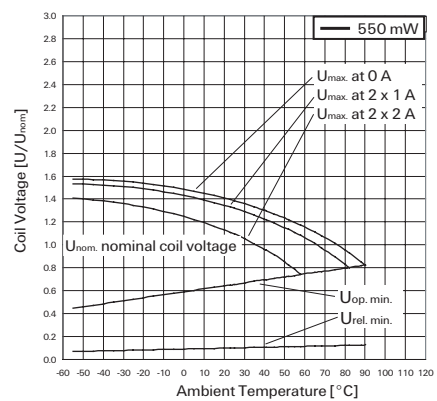

Coil operative range graphs

- $U_{nom}$  Nominal coil voltage
- $U_{max}$  Upper limit of the operative range of the coil voltage (limiting voltage) when coils are continuously energized
- $U_{op. min.}$  Lower limit of the operative range of the coil voltage (reliable operate voltage)
- $U_{rel. min.}$  Lower limit of the operative range of the coil voltage (reliable release voltage)

Insulation Data

Initial dielectric strength	
between open contacts	750V <sub>rms</sub>
between contact and coil	1050V <sub>rms</sub>
between adjacent contacts	750V <sub>rms</sub>
Initial surge withstand voltage	
between open contacts	1500V
between contact and coil	1500V
between adjacent contacts	1500V
Initial insulation resistance at 500VDC	> 10 <sup>9</sup> Ω
Capacitance	
between open contacts	max. 2pF
between contact and coil	max. 4pF
between adjacent contacts	max. 2 pF

RF Data

Isolation at 100MHz/900MHz	-31.8dB/-14.2dB
Insertion loss at 100MHz/900MHz	-0.02dB/-0.97dB
Voltage standing wave ratio (VSWR) at 100MHz/900MHz	1.03/1.31

Other Data

Material compliance: EU RoHS/ELV, China RoHS, REACH, Halogen content refer to the Product Compliance Support Center at [www.te.com/customer-support/rohssupportcenter](http://www.te.com/customer-support/rohssupportcenter)

Ambient temperature	-55 to +85°C
Category of environmental protection	
IEC 61810	RT III - immersion cleanable
Degree of protection, IEC 60529	IP 67
Vibration resistance (functional)	10g, 10 to 500Hz
Shock resistance (functional)	
IEC 60068-2-27 (half sine)	10g/30g
Shock resistance (destructive)	500g
Terminal type	PCB-THT
Weight	max. 5g
Resistance to soldering heat THT	
IEC 60068-2-20	265 °C / 10 s
Ultrasonic cleaning	not recommended
Packaging unit	1000 pcs.

**MT2 Relay (Continued)**

**Terminal assignment**

TOP view on component side of PCB

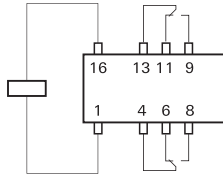

**PCB layout**

TOP view on component side of PCB

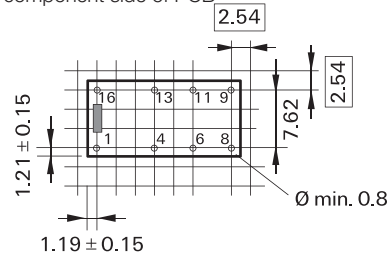

**Dimensions**

Orientation mark

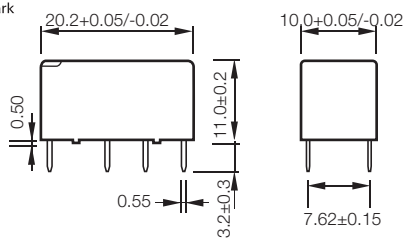

**Packing**

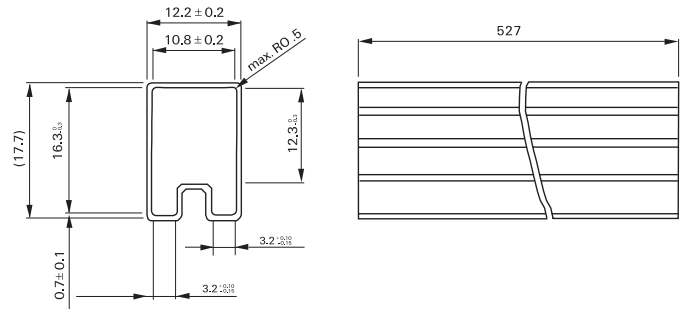

**Product code structure**

Typical product code **C934 22**

**Type**  
**C934** MT2 Series Signal Relay  
2 form C, 2 CO, AgNi +Au contacts

**Coil**  
Coil code: please refer to coil versions table

**MT2 Relay** (Continued)

Product code	Version	Coil	Coil power	Coil voltage	Part number	
C93400	2 form C (2CO) AgNi+Au contacts	High sensitive	150mW	3VDC	1-1462001-2	
C93407				3.3VDC	1-1462001-3	
C93406				4.5VDC	2-1462000-2	
C93401				5VDC	1462000-1	
C93427				6VDC	5-1462000-6	
C93405				9VDC	2-1462000-0	
C93402				12VDC	1462000-7	
C93403				24VDC	1-1462000-3	
C93404				48VDC	1-1462000-8	
C93414				Sensitive	200mW	3VDC
C93415	4.5VDC	3-1462000-0				
C93416	5VDC	3-1462000-1				
C93428	6VDC	5-1462000-7				
C93417	9VDC	3-1462000-6				
C93418	12VDC	3-1462000-7				
C93419	24VDC	4-1462000-1				
C93420	48VDC	4-1462000-5				
C93433	Sensitive	300mW	4.5VDC			6-1462000-6
C93434			5VDC			6-1462000-8
C93412			12VDC	2-1462000-6		
C93435			24VDC	7-1462000-0		
C93436			48VDC	7-1462000-2		
C93421			Standard	400mW	4.5VDC	4-1462000-7
C93422	5VDC	4-1462000-8				
C93423	9VDC	5-1462000-0				
C93424	12VDC	5-1462000-1				
C93425	24VDC	5-1462000-3				
C93426	48VDC	5-1462000-5				
C93438	Standard	550mW	4.5VDC	7-1462000-7		
C93450			5VDC	8-1462000-5		
C93437			6VDC	7-1462000-6		
C93432			12VDC	6-1462000-2		
C93431			24VDC	6-1462000-1		
C93430			48VDC	5-1462000-9		