

CLC501

CLC501 High Speed, Output Clamping Op Amp



Literature Number: SNOS858C

High Speed, Output Clamping Op Amp

General Description

The CLC501 is a high speed current-feedback op amp with the unique feature of output voltage clamping. This feature allows both the maximum positive (V_{HIGH}) and negative (V_{LOW}) output voltage levels to be established. This is useful in a number of applications in which "downstream" circuitry must be protected from over driving input signals. Not only can this prevent damage to downstream circuitry, but can also reduce time delays since saturation is avoided. The CLC501's very fast 1ns overload/clamping recovery time is useful in applications in which information containing signals follow over-driving signals.

Engineers designing high resolution, subranging A/D systems have long sought an amplifier capable of meeting the demanding requirements of the residue amplifier function. Amplifiers providing the residue function must not only settle quickly, but recover from overdrive quickly, protect the second stage A/D, and provide high fidelity at relatively high gain settings. The CLC501, which excels in these areas, is the ideal design solution in this onerous application. To further support this application, the CLC501 is both characterized and tested at a gain setting of +32—the most common gain setting for residue amplifier applications.

The CLC501's other features provide a quick, high performance design solution. Since the CLC501's current feedback design requires no external compensation, designers need not spend their time designing compensation networks. The small 8-pin package and low, 180mW power consumption make the CLC501 ideal in numerous applications having small power and size budgets.

The CLC501 is available in several versions to meet a variety of requirements. A three letter suffix determines the version:

- Enhanced Solutions (Military/Aerospace)
- SMD Number: 5962-94597

*Space level version also available.

*For more information, visit <http://www.national.com/mil>

Features

- Output clamping (V_{HIGH} and V_{LOW})
- 1ns recovery from clamping/overdrive
- 0.05% settling in 12ns
- Characterized and guaranteed at $A_V = +32$
- Low power: 180mW

Applications

- Residue amplifier in high accuracy, subranging A/D systems
- High speed communications
- Output clamping applications
- Pulse amplitude modulation systems

Clamped Pulse Response

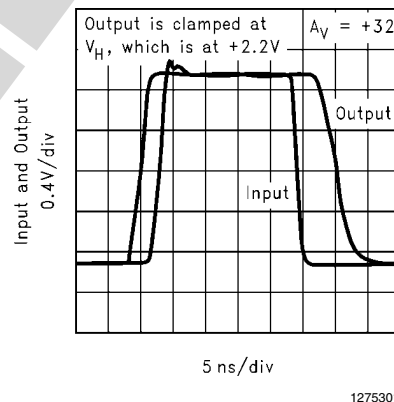

Connection Diagrams

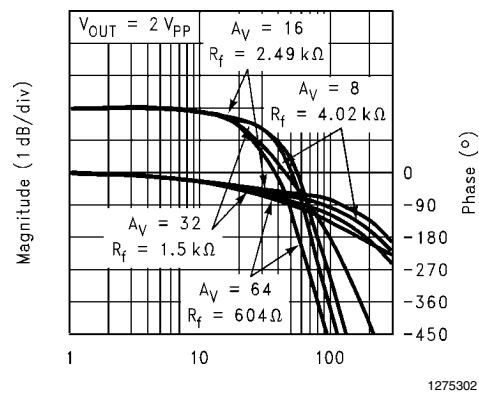
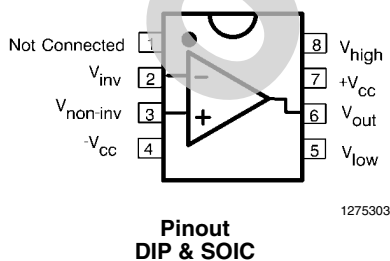

Ordering Information

Package	Temperature Range Industrial	Part Number	Package Marking	NSC Drawing
8-Pin Plastic DIP	-40°C to +85°C	CLC501AJP	CLC501AJP	N08E
8-Pin Plastic SOIC	-40°C to +85°C	CLC501AJE	CLC501AJE	M08A

OBSOLETE

Absolute Maximum Ratings (Note 1)

If Military/Aerospace specified devices are required, please contact the National Semiconductor Sales Office/Distributors for availability and specifications.

Supply Voltage (V_{CC}) $\pm 7V$

I_{OUT}
Output is short circuit protected to ground, but maximum reliability will be maintained if I_{OUT} does not exceed...

Common Mode Input Voltage $\pm V_{CC}$

Junction Temperature $+150^{\circ}C$

Operating Temperature Range $-40^{\circ}C$ to $+85^{\circ}C$

Storage Temperature Range $-65^{\circ}C$ to $+150^{\circ}C$

Lead Solder Duration ($+300^{\circ}C$) 10 sec

ESD Rating (Human Body Model) $<1000V$

Recommended Gain Range $+7$ to $+50$
 -1 to -50

Operating Ratings

Thermal Resistance

Package	(θ_{JC})	(θ_{JA})
MDIP	$70^{\circ}C/W$	$125^{\circ}C/W$
SOIC	$65^{\circ}C/W$	$145^{\circ}C/W$

Electrical Characteristics

($A_V = +32$, $V_{CC} = \pm 5V$, $R_L = 100\Omega$, $R_f = 1.5\Omega$, $V_H = +3V$; unless specified)

Symbol	Parameters	Condition	Typ	Max & Min Ratings(Note 2)			Units
Ambient Temperature		CLC501AJ	$+25^{\circ}C$	$-40^{\circ}C$	$+25^{\circ}C$	$+85^{\circ}C$	
Frequency Domain Response							
SSBW	-3dB Bandwidth	$V_{OUT} < 5V_{PP}$	75	>60	>60	>45	MHz
SS20	-3dB Bandwidth	@ $A_V = +20$, $V_{OUT} < 2V_{PP}$	110	>85	>85	>55	MHz
	Gain Flatness	$V_{OUT} < 5V_{PP}$					
GFPL	Peaking	$<15MHz$	0	<0.1	<0.1	<0.1	dB
GFPH	Peaking	$>15MHz$	0	<0.2	<0.2	<0.2	dB
GFR	Rolloff	$<30MHz$	0.2	<1.0	<1.0	<1.3	dB
LPD	Linear Phase Deviation	DC to 30MHz	0.2	<1.0	<1.0	<1.0	deg
Time Domain Response							
TRS	Rise and Fall Time	2V Step	4.7	<5.8	<5.8	<7.8	ns
TRL		5V Step	5.5	<6.5	<6.5	<8.0	ns
TSP	Settling Time to $\pm 0.05\%$	2V Step	12	<18	<18	<24	ns
OS	Overshoot	2V Step	0	<5	<5	<5	%
SR	Slew Rate		1200	>800	>800	>700	V/ μs
Distortion And Noise Response							
HD2	2nd Harmonic Distortion	$2V_{PP}$, 20MHz	-45	<-30	<-33	<-30	dBc
HD3	3rd Harmonic Distortion	$2V_{PP}$, 20MHz	-60	<-45	<-50	<-50	dBc
	Equivalent Input Noise						
SNF	Noise Floor	$>1MHz$	-158	<-156	<-156	<-155	dBm (1Hz)
INV	Integrated Noise	1MHz to 100MHz	28	<35	<35	<40	μV
Clamp Performance							
OVC	Overshoot in Clamp	32x Overdrive	5	-	<15	-	%
TSO	Overload Recovery from Clamp	32x Overdrive	1	<3	<3	<3	ns
CDR	V_{io} Drift after Recovery		150	<200	<200	<200	μV
VOC	Clamp Accuracy(Note 3)	$>2x$ Overdrive	0.1	<0.2	<0.2	<0.2	V
ICL	Input Bias Current on V_H , V_L		20	<100	<50	<50	μA
CBW	-3dB Bandwidth	$V_L, V_H = 2V_{PP}$	50	-	-	-	MHz
CMC	Useful Clamping Range	V_H or V_L		$<\pm 3.0$	$<\pm 3.3$	$<\pm 3.3$	V
Static, DC Performance							
VIO	Input Offset Voltage(Note 3)		1.5	<4.6	<3.0	<5.0	mV
DVIO	Average Temperature Coefficient		10	<20	-	<20	$\mu V/^{\circ}C$
IBN	Input Bias Current(Note 3)	Non-Inverting	10	<37	<25	<35	μA

Symbol	Parameters	Condition	Typ	Max & Min Ratings(Note 2)			Units
DIBN	Average Temperature Coefficient		100	<150	–	<100	nA/°C
IBI	Input Bias Current(Note 3)	Inverting	10	<46	<30	<40	μA
DIBI	Average Temperature Coefficient		100	<200	–	<100	nA/°C
PSRR	Power Supply Rejection Ratio		70	>55	>60	>60	dB
CMRR	Common Mode Rejection Ratio		70	>55	>60	>60	dB
ICC	Supply Current(Note 3)	No Load	18	<25	<24	<24	mA
Miscellaneous Performance							
RIN	Non-Inverting Input	Resistance	150	>50	>100	>100	kΩ
CIN		Capacitance	4	<7	<7	<7	pF
RO	Output Impedance	at DC	0.2	<0.3	<0.3	<0.3	Ω
CMIR	Common Mode Input Range		3.0	>2.0	>2.5	>2.5	V
VO	Output Voltage Range	No Load	±3.5V	>±3.0	>±3.2	>±3.2	V
IO	Output Current	–40°C to +85°C	±60	>±35	>±50	>±50	mA
IO		–55°C to +125°C	±60	>±30	>±50	>±50	mA

Note 1: "Absolute Maximum Ratings" are those values beyond which the safety of the device cannot be guaranteed. They are not meant to imply that the devices should be operated at these limits. The table of "Electrical Characteristics" specifies conditions of device operation.

Note 2: Min/max ratings are based on product characterization and simulation. Individual parameters are tested as noted. Individual parameters are tested as noted. Outgoing quality levels are determined from tested parameters.

Note 3: AJ 100% tested at +25°C, sample at +85°C

Typical Performance Characteristics ($T_A = 25^\circ\text{C}$, $A_V = +32$, $V_{CC} = \pm 5\text{V}$, $R_L = 100\Omega$, $R_f = 1.5\text{k}\Omega$, $V_H = +3\text{V}$, $V_L = -3\text{V}$)

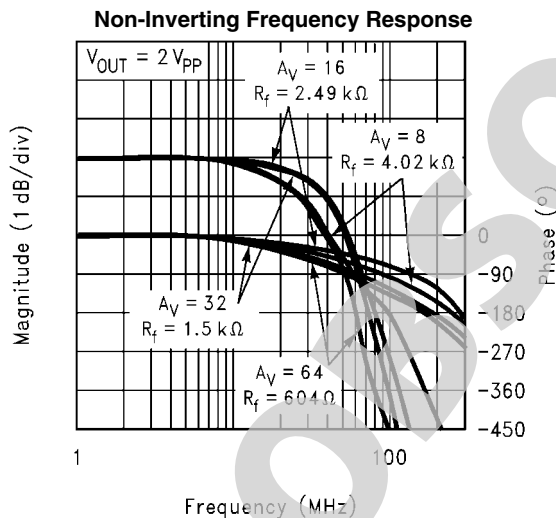

1275304

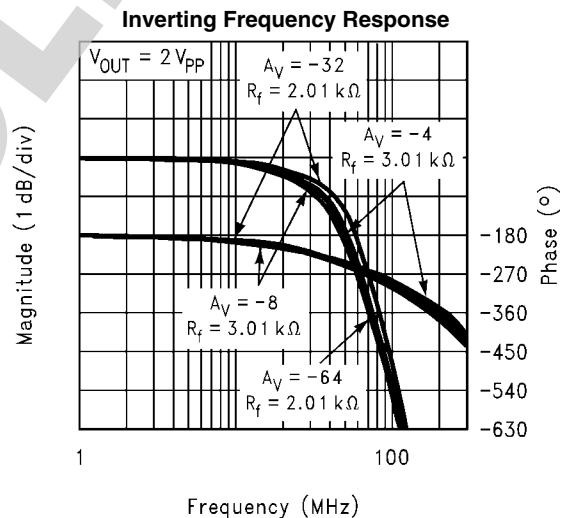

1275305

Frequency Response for $R_L S$

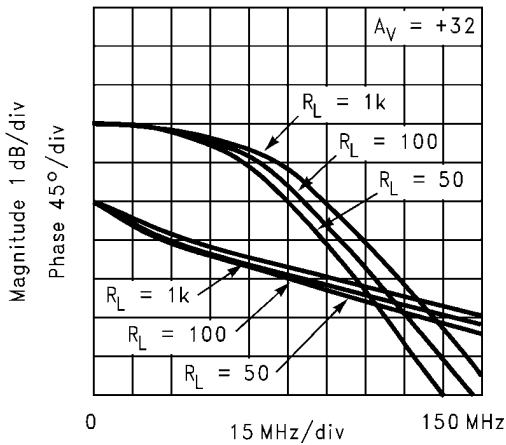

1275306

Open-Loop Transimpedance Gain, $Z(s)$

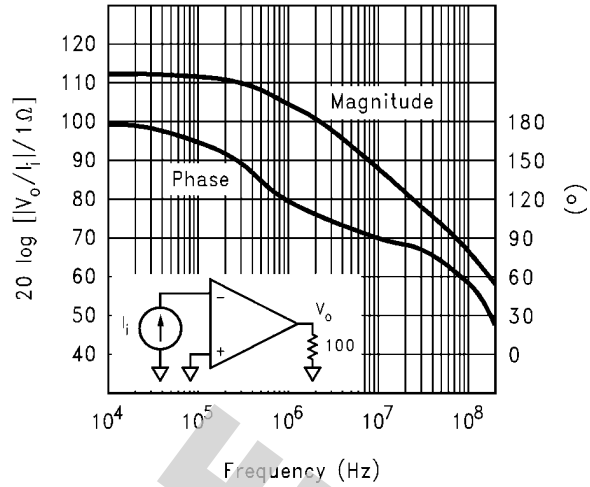

1275307

2nd and 3rd Harmonic Distortion

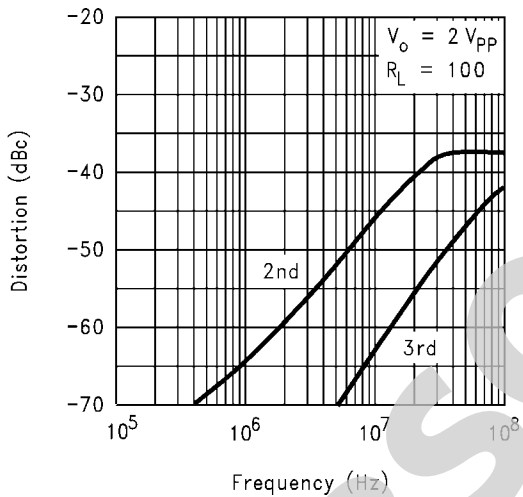

1275308

2-Tone, 3rd Order, Intermodulation Intercept

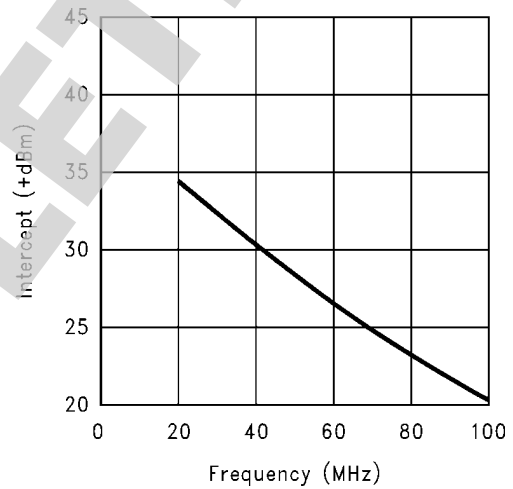

1275309

Equivalent Input Noise

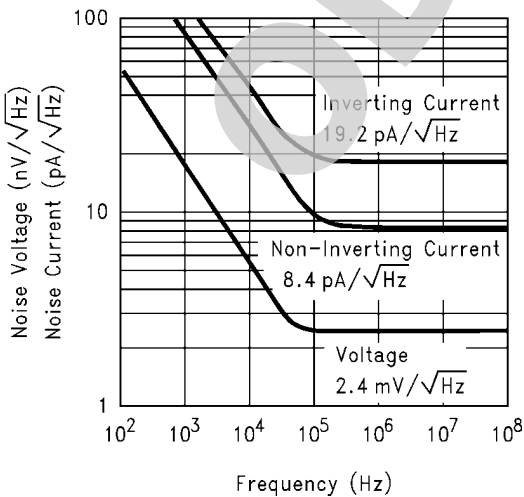

1275310

CMRR and PSRR

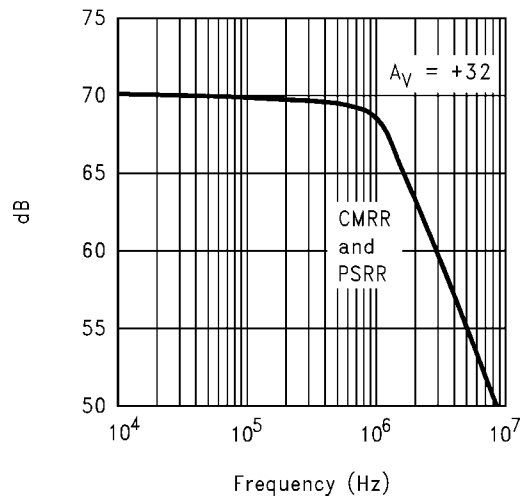

1275311

Clamped Pulse Response

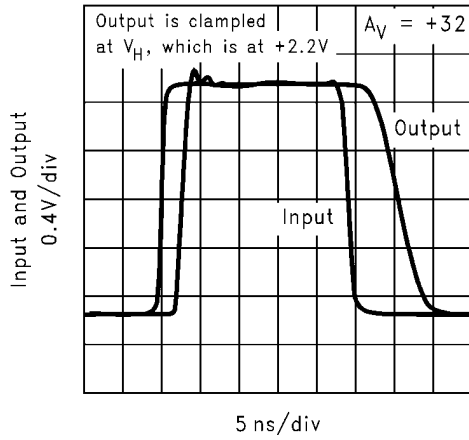

Settling, Clamped (32x overdrive)

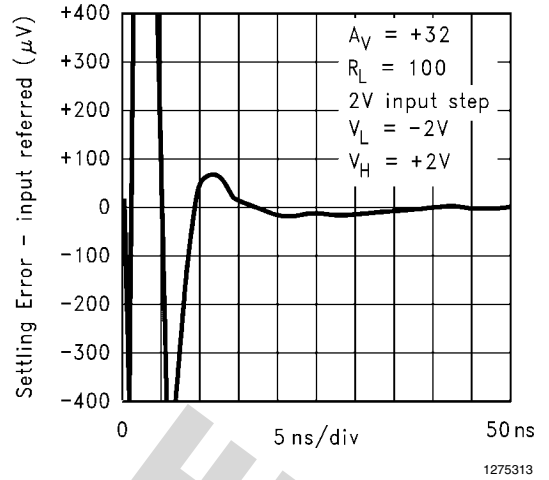

Long-Term Settling, Clamped (32x overdrive)

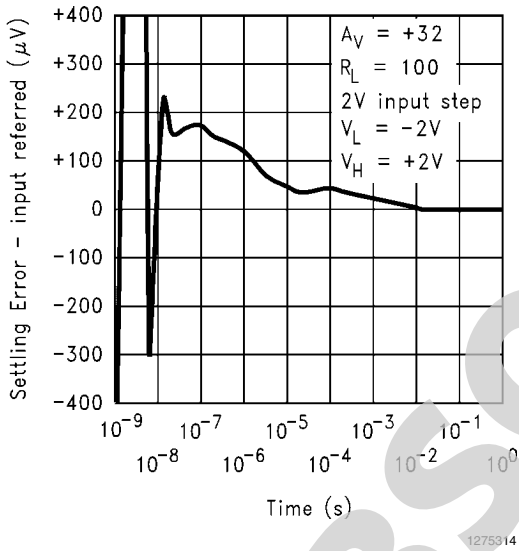

Nonlinearity Near Clamp Voltage

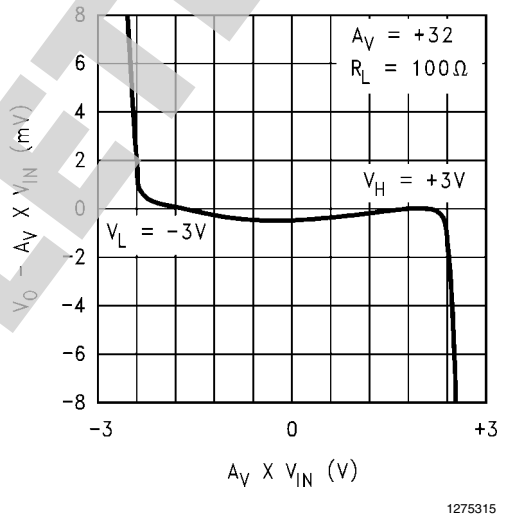

Settling, Unclamped

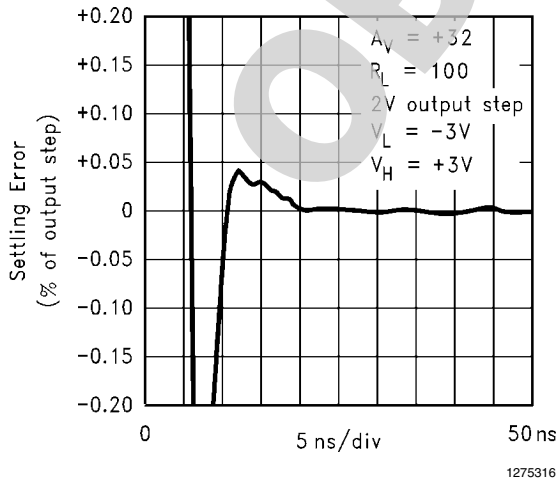

Long-Term Settling, Unclamped

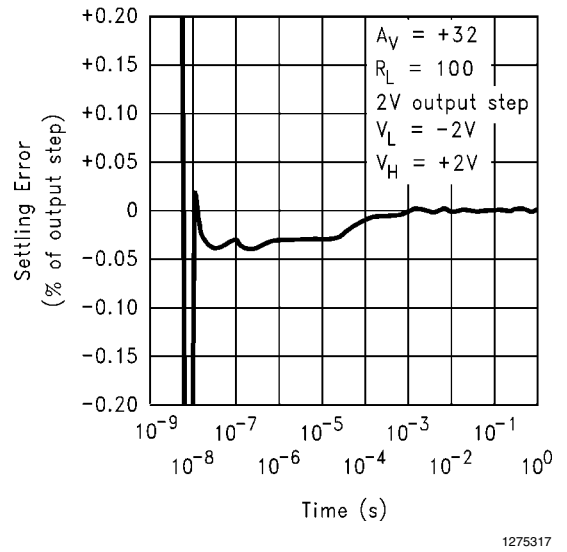

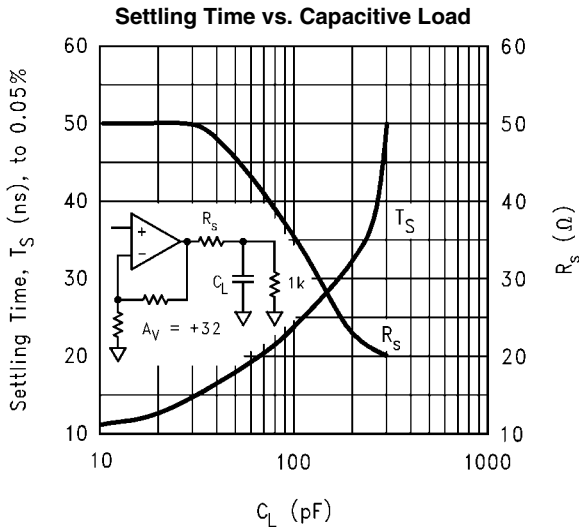

1275318

Application Division

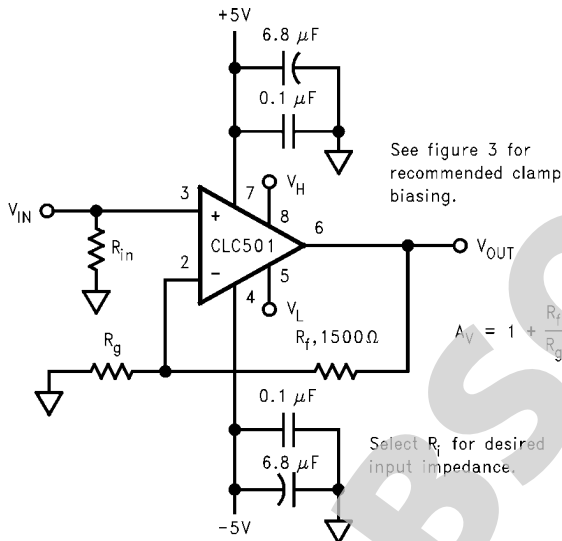

1275319

FIGURE 1. Recommended non-Inverting gain circuit

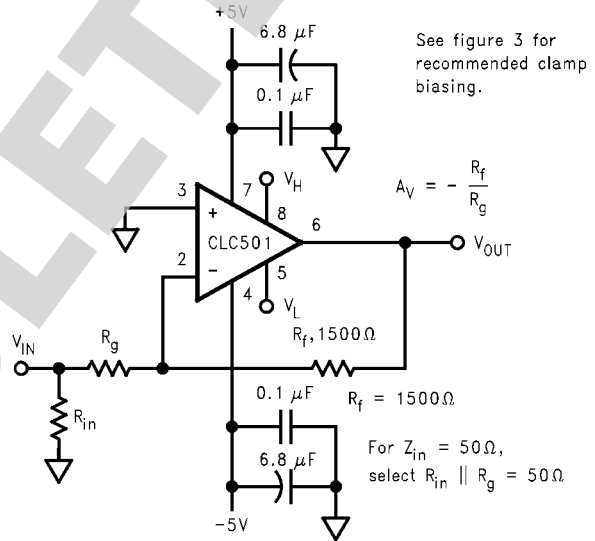

1275320

FIGURE 2. Recommended Inverting gain circuit

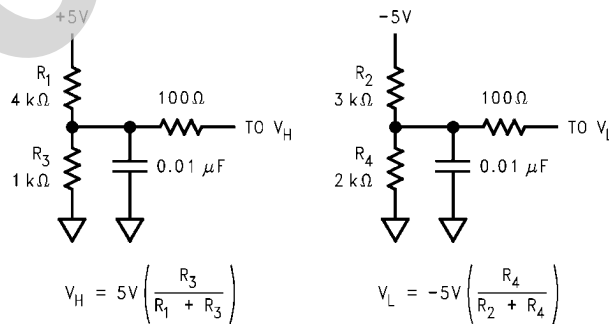

1275321

FIGURE 3. Recommended clamp biasing for clamp levels of +1V and -2V

Clamp Operation

The maximum positive or negative excursion of the output voltage is determined by voltage applied to the clamping pins, V_H and V_L . V_H determines the positive clamping level; V_L determines the negative level. For example, if V_H is set at +2V and V_L is set at -0.5V the output voltage is restricted within this -0.5V to +2V range. When the output voltage tries to exceed this level, the amplifier goes into "clamp mode" and the output voltage limits at the clamp voltage.

Clamp Accuracy and Amplifier Linearity

Ideally, the clamped output voltage and the clamp voltage should be identical. In practice, however, there are two sources of clamp inaccuracy: the inherent clamp accuracy (which is shown in the specification page) and resistor divider action of open-loop output resistance of 10 Ω and the load resistor. Or, in equation form,

$$V_{OUT, CLAMP} = (V_{H \text{ or } L} \pm 200 \text{ mV}) \frac{R_L}{R_L + 10 \Omega} \quad (1)$$

When setting the clamping voltage, the designer should also recognize that within about 200mV of the clamp voltage, amplifier linearity begins to deteriorate. (See plot on the previous page.)

Biasing V_H and V_L

Each of the clamping pins is buffered internally so simple resistive voltage divider circuits work well in providing the clamp voltages (see *Figure 3*). The 100 Ω isolating resistor ensures stability when the clamp pin is connected to V_{CC} or when the clamp pins is driven by an external signal source; in other situations, such as the one described in *Figure 3*, the isolating resistor is not necessary.

V_H should be biased more positively than V_L . V_H may be biased below 0V; however, with this biasing, the output voltage will actually clamp at 0V unless a simple pull down circuit is added to the op amp output. (When clamped against V_H , the output cannot sink current.) An analogous situation and design solution exists for V_L when it is biased above 0V, but in this case, a pull up circuit is used to source current when the amplifier is clamped against V_L .

The clamps, which have a bandwidth of about 50MHz, may be driven by high frequency signal source. This allows the clamping level to be modulated, which is useful in many applications such as pulse amplitude modulation. The source resistance of the signal source should be less than 500 Ω to ensure stability.

Clamp-Mode Dynamics

As can be seen in the clamped pulse response plot on the previous page, clamping is virtually instantaneous. Note, however, that there can be a small amount of overshoot, as indicated on the specification page. The output voltage stays at the clamp voltage level as long as the product of the input voltage and the gain setting exceeds the clamp voltage. When the input voltage decreases, it will eventually reach a point where it is no longer trying to drive the output voltage above the clamp voltage. when this occurs, there is typically a 1ns "overload recovery from clamp," which is the time it takes for the op amp to resume linear operation. The normal op amp parameters, such as the rise time, apply when the op amp is in linear operation.

When the op amp is in clamp mode for more than about 100ns, a small thermal tail can be detected in the settling per-

formance. This tail, which has a maximum value of 200 μ V referred to the input, is proportional to the amount of time spent in clamp in clamp mode. In most applications, this will have only a minor effect. For example, in a system with a 100ns overdrive occurring with a duty cycle of 10%, the input-referred tail is 20 μ V which is only 0.001% of a 2V signal.

DC Accuracy and Noise

Since the two inputs for the CLC501 are quite dissimilar, the noise and offset error performance differs somewhat from that of a standard differential input amplifier. Specifically, the inverting input current noise is much larger than the non-inverting current noise. Also the two input bias currents are physically unrelated rendering bias current cancellation through matching of the inverting and non-inverting pin resistors ineffective.

In equation 3, the output offset is the algebraic sum of the equivalent input voltage and current sources that influence DC operation. Output noise is determined similarly except that a root-sum-of-squares replaced the algebraic sum. R_s is the non-inverting pin resistance.

PSRR and CMRR

The PSRR and CMRR performance plots on the previous page show performance for a circuit set at a gain of +32 and a source resistance of 0 Ω . In current feedback op amps, common mode and power supply variations manifest themselves in changes in the op amp's bias currents (IBI for the inverting input and IBN for the non-inverting input) and in the offset voltage (VIO). At DC, these values are:

$$\begin{aligned} \text{CMRR: } \frac{\Delta V_{IO}}{\Delta V_{cm}} &= 130 \mu\text{V/V} & \text{PSRR: } \frac{\Delta V_{IO}}{\Delta V_{CC}} &= 180 \mu\text{V/V} \\ \frac{\Delta IBN}{\Delta V_{cm}} &= 6 \mu\text{A/V} & \frac{\Delta IBN}{\Delta V_{CC}} &= 3 \mu\text{A/V} \\ \frac{\Delta IBI}{\Delta V_{cm}} &= 2 \mu\text{A/V} & \frac{\Delta IBI}{\Delta V_{CC}} &= 3 \mu\text{A/V} \end{aligned} \quad (2)$$

The total effect, as reference to the input, is given by the following:

$$\begin{aligned} \text{PSRR} &= -20 \log \left[\frac{\Delta V_{IO}}{\Delta V_{CC}} + \frac{\Delta IBN}{\Delta V_{CC}} R_s + \frac{\Delta IBI}{\Delta V_{CC}} R_{eq} \right] \\ \text{CMRR} &= -20 \log \left[\frac{\Delta V_{IO}}{\Delta V_{cm}} + \frac{\Delta IBN}{\Delta V_{cm}} R_s + \frac{\Delta IBI}{\Delta V_{cm}} R_{eq} \right] \end{aligned} \quad (3)$$

Where R_s is the equivalent resistance seen by the non-inverting input and R_{eq} is the equivalent resistance of R_g in parallel with R_f .

Printed circuit Layout

As with any high frequency device, a good PCB layout will enhance performance. Ground plane construction and good power supply bypassing close to the package are critical to achieving full performance. In the non-inverting configuration, the amplifier is sensitive to stray capacitance to ground at the inverting input. Hence, the inverting node connections should be small with minimal coupling to the ground plane. Shunt capacitance across the feedback resistor should not be used to compensate for this effect.

Evaluation PC boards (part number CLC730013 for through-hole and CLC730027 for SOIC) for the CLC501 are available.

Physical Dimensions inches (millimeters) unless otherwise noted

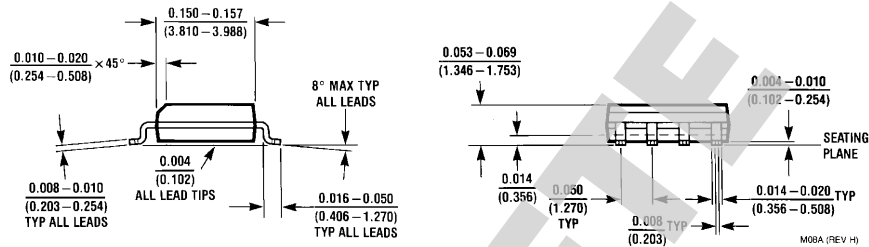
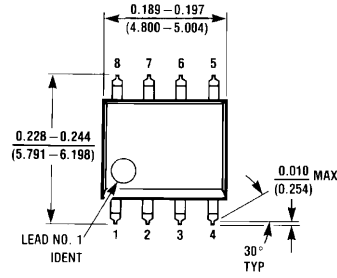

8-Pin SOIC
NS Package Number M08A

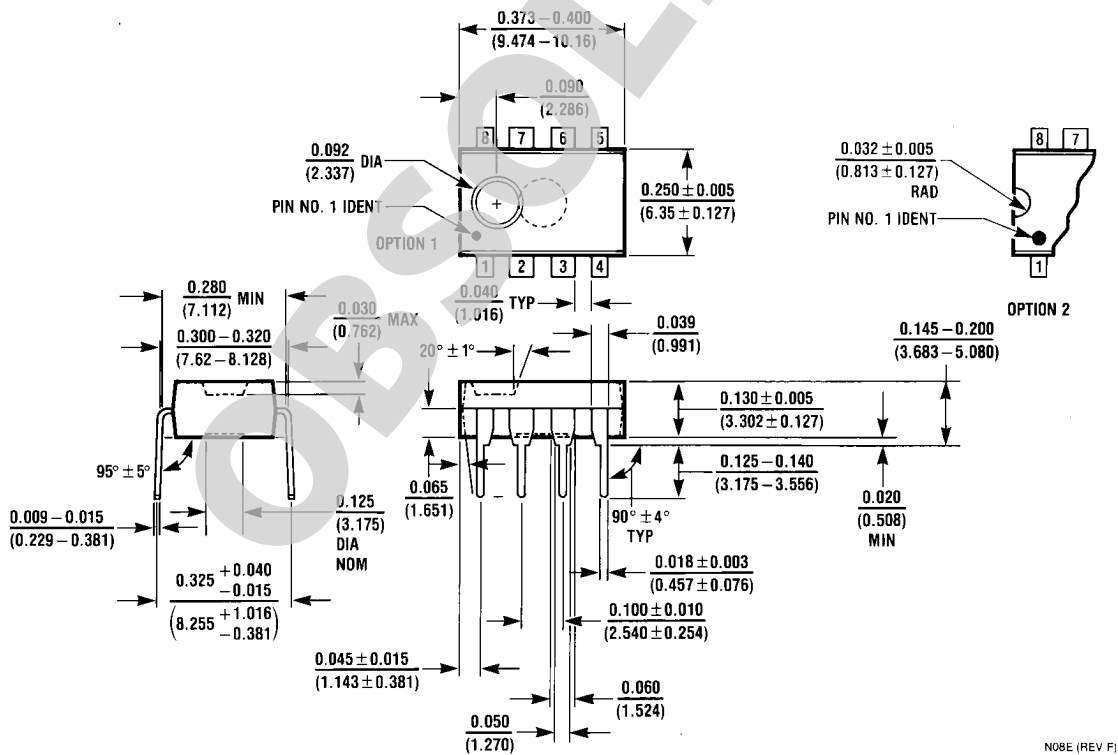

8-Pin MDIP
NS Package Number N08E

Notes

For more National Semiconductor product information and proven design tools, visit the following Web sites at:

Products		Design Support	
Amplifiers	www.national.com/amplifiers	WEBENCH® Tools	www.national.com/webench
Audio	www.national.com/audio	App Notes	www.national.com/appnotes
Clock and Timing	www.national.com/timing	Reference Designs	www.national.com/refdesigns
Data Converters	www.national.com/adc	Samples	www.national.com/samples
Interface	www.national.com/interface	Eval Boards	www.national.com/evalboards
LVDS	www.national.com/lvds	Packaging	www.national.com/packaging
Power Management	www.national.com/power	Green Compliance	www.national.com/quality/green
Switching Regulators	www.national.com/switchers	Distributors	www.national.com/contacts
LDOs	www.national.com/ldo	Quality and Reliability	www.national.com/quality
LED Lighting	www.national.com/led	Feedback/Support	www.national.com/feedback
Voltage Reference	www.national.com/vref	Design Made Easy	www.national.com/easy
PowerWise® Solutions	www.national.com/powerwise	Solutions	www.national.com/solutions
Serial Digital Interface (SDI)	www.national.com/sdi	Mil/Aero	www.national.com/milaero
Temperature Sensors	www.national.com/tempensors	SolarMagic™	www.national.com/solarmagic
Wireless (PLL/VCO)	www.national.com/wireless	PowerWise® Design University	www.national.com/training

THE CONTENTS OF THIS DOCUMENT ARE PROVIDED IN CONNECTION WITH NATIONAL SEMICONDUCTOR CORPORATION ("NATIONAL") PRODUCTS. NATIONAL MAKES NO REPRESENTATIONS OR WARRANTIES WITH RESPECT TO THE ACCURACY OR COMPLETENESS OF THE CONTENTS OF THIS PUBLICATION AND RESERVES THE RIGHT TO MAKE CHANGES TO SPECIFICATIONS AND PRODUCT DESCRIPTIONS AT ANY TIME WITHOUT NOTICE. NO LICENSE, WHETHER EXPRESS, IMPLIED, ARISING BY ESTOPPEL OR OTHERWISE, TO ANY INTELLECTUAL PROPERTY RIGHTS IS GRANTED BY THIS DOCUMENT.

TESTING AND OTHER QUALITY CONTROLS ARE USED TO THE EXTENT NATIONAL DEEMS NECESSARY TO SUPPORT NATIONAL'S PRODUCT WARRANTY. EXCEPT WHERE MANDATED BY GOVERNMENT REQUIREMENTS, TESTING OF ALL PARAMETERS OF EACH PRODUCT IS NOT NECESSARILY PERFORMED. NATIONAL ASSUMES NO LIABILITY FOR APPLICATIONS ASSISTANCE OR BUYER PRODUCT DESIGN. BUYERS ARE RESPONSIBLE FOR THEIR PRODUCTS AND APPLICATIONS USING NATIONAL COMPONENTS. PRIOR TO USING OR DISTRIBUTING ANY PRODUCTS THAT INCLUDE NATIONAL COMPONENTS, BUYERS SHOULD PROVIDE ADEQUATE DESIGN, TESTING AND OPERATING SAFEGUARDS.

EXCEPT AS PROVIDED IN NATIONAL'S TERMS AND CONDITIONS OF SALE FOR SUCH PRODUCTS, NATIONAL ASSUMES NO LIABILITY WHATSOEVER, AND NATIONAL DISCLAIMS ANY EXPRESS OR IMPLIED WARRANTY RELATING TO THE SALE AND/OR USE OF NATIONAL PRODUCTS INCLUDING LIABILITY OR WARRANTIES RELATING TO FITNESS FOR A PARTICULAR PURPOSE, MERCHANTABILITY, OR INFRINGEMENT OF ANY PATENT, COPYRIGHT OR OTHER INTELLECTUAL PROPERTY RIGHT.

LIFE SUPPORT POLICY

NATIONAL'S PRODUCTS ARE NOT AUTHORIZED FOR USE AS CRITICAL COMPONENTS IN LIFE SUPPORT DEVICES OR SYSTEMS WITHOUT THE EXPRESS PRIOR WRITTEN APPROVAL OF THE CHIEF EXECUTIVE OFFICER AND GENERAL COUNSEL OF NATIONAL SEMICONDUCTOR CORPORATION. As used herein:

Life support devices or systems are devices which (a) are intended for surgical implant into the body, or (b) support or sustain life and whose failure to perform when properly used in accordance with instructions for use provided in the labeling can be reasonably expected to result in a significant injury to the user. A critical component is any component in a life support device or system whose failure to perform can be reasonably expected to cause the failure of the life support device or system or to affect its safety or effectiveness.

National Semiconductor and the National Semiconductor logo are registered trademarks of National Semiconductor Corporation. All other brand or product names may be trademarks or registered trademarks of their respective holders.

Copyright© 2009 National Semiconductor Corporation

For the most current product information visit us at www.national.com



www.national.com

**National Semiconductor
Americas Technical
Support Center**
Email: support@nsc.com
Tel: 1-800-272-9959

**National Semiconductor Europe
Technical Support Center**
Email: europe.support@nsc.com

**National Semiconductor Asia
Pacific Technical Support Center**
Email: ap.support@nsc.com

**National Semiconductor Japan
Technical Support Center**
Email: jpn.feedback@nsc.com

IMPORTANT NOTICE

Texas Instruments Incorporated and its subsidiaries (TI) reserve the right to make corrections, modifications, enhancements, improvements, and other changes to its products and services at any time and to discontinue any product or service without notice. Customers should obtain the latest relevant information before placing orders and should verify that such information is current and complete. All products are sold subject to TI's terms and conditions of sale supplied at the time of order acknowledgment.

TI warrants performance of its hardware products to the specifications applicable at the time of sale in accordance with TI's standard warranty. Testing and other quality control techniques are used to the extent TI deems necessary to support this warranty. Except where mandated by government requirements, testing of all parameters of each product is not necessarily performed.

TI assumes no liability for applications assistance or customer product design. Customers are responsible for their products and applications using TI components. To minimize the risks associated with customer products and applications, customers should provide adequate design and operating safeguards.

TI does not warrant or represent that any license, either express or implied, is granted under any TI patent right, copyright, mask work right, or other TI intellectual property right relating to any combination, machine, or process in which TI products or services are used. Information published by TI regarding third-party products or services does not constitute a license from TI to use such products or services or a warranty or endorsement thereof. Use of such information may require a license from a third party under the patents or other intellectual property of the third party, or a license from TI under the patents or other intellectual property of TI.

Reproduction of TI information in TI data books or data sheets is permissible only if reproduction is without alteration and is accompanied by all associated warranties, conditions, limitations, and notices. Reproduction of this information with alteration is an unfair and deceptive business practice. TI is not responsible or liable for such altered documentation. Information of third parties may be subject to additional restrictions.

Resale of TI products or services with statements different from or beyond the parameters stated by TI for that product or service voids all express and any implied warranties for the associated TI product or service and is an unfair and deceptive business practice. TI is not responsible or liable for any such statements.

TI products are not authorized for use in safety-critical applications (such as life support) where a failure of the TI product would reasonably be expected to cause severe personal injury or death, unless officers of the parties have executed an agreement specifically governing such use. Buyers represent that they have all necessary expertise in the safety and regulatory ramifications of their applications, and acknowledge and agree that they are solely responsible for all legal, regulatory and safety-related requirements concerning their products and any use of TI products in such safety-critical applications, notwithstanding any applications-related information or support that may be provided by TI. Further, Buyers must fully indemnify TI and its representatives against any damages arising out of the use of TI products in such safety-critical applications.

TI products are neither designed nor intended for use in military/aerospace applications or environments unless the TI products are specifically designated by TI as military-grade or "enhanced plastic." Only products designated by TI as military-grade meet military specifications. Buyers acknowledge and agree that any such use of TI products which TI has not designated as military-grade is solely at the Buyer's risk, and that they are solely responsible for compliance with all legal and regulatory requirements in connection with such use.

TI products are neither designed nor intended for use in automotive applications or environments unless the specific TI products are designated by TI as compliant with ISO/TS 16949 requirements. Buyers acknowledge and agree that, if they use any non-designated products in automotive applications, TI will not be responsible for any failure to meet such requirements.

Following are URLs where you can obtain information on other Texas Instruments products and application solutions:

Products

Audio	www.ti.com/audio
Amplifiers	amplifier.ti.com
Data Converters	dataconverter.ti.com
DLP® Products	www.dlp.com
DSP	dsp.ti.com
Clocks and Timers	www.ti.com/clocks
Interface	interface.ti.com
Logic	logic.ti.com
Power Mgmt	power.ti.com
Microcontrollers	microcontroller.ti.com
RFID	www.ti-rfid.com
OMAP Mobile Processors	www.ti.com/omap
Wireless Connectivity	www.ti.com/wirelessconnectivity

Applications

Communications and Telecom	www.ti.com/communications
Computers and Peripherals	www.ti.com/computers
Consumer Electronics	www.ti.com/consumer-apps
Energy and Lighting	www.ti.com/energy
Industrial	www.ti.com/industrial
Medical	www.ti.com/medical
Security	www.ti.com/security
Space, Avionics and Defense	www.ti.com/space-avionics-defense
Transportation and Automotive	www.ti.com/automotive
Video and Imaging	www.ti.com/video

TI E2E Community Home Page

e2e.ti.com

Mailing Address: Texas Instruments, Post Office Box 655303, Dallas, Texas 75265
Copyright © 2011, Texas Instruments Incorporated