

Surface Mounting DPDT Relay

- Long terminals for ideal for soldering and mounting reliability.
- Space-saving inside-L terminal.
- High dielectric strength between coil and contacts (2,000 VAC), and between contacts of different polarity (1,500 VAC).
- High impulse withstand voltages between coil and contacts, and between contacts of different polarity (2,500 V, 2 × 10 μs: Bellcore requirements).
- Low power consumption (140 mW).
- Bifurcated crossbar contact (Au-clad) and Fully sealed construction for high reliability.
- Applicable to IRS.
- High sealability after IRS.
- Ultra-miniature at 15 × 7.5 × 9.4 mm (L × W × H).
- Through-hole terminal is available
- EN60950/EN41003 Supplementary Insulation-certified type is available.

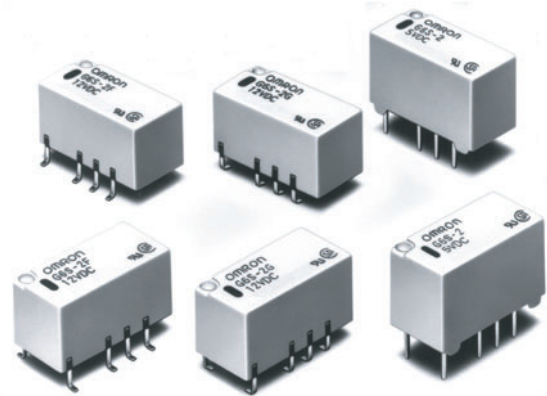

RoHS Compliant

Ordering Information

| Classification | | | | Single-side stable | Single-winding latching | Double-winding latching | Single-side stable EN60950/EN41003 |
|----------------|--------------|---------------------------|-----------|--------------------|-------------------------|-------------------------|------------------------------------|
| DPDT | Fully sealed | PCB terminal | | G6S-2 | G6SU-2 | G6SK-2 | G6S-2-Y |
| | | Surface mounting terminal | Inside-L | G6S-2G | G6SU-2G | G6SK-2G | G6S-2G-Y |
| | | | Outside-L | G6S-2F | G6SU-2F | G6SK-2F | G6S-2F-Y |

- Note:**
1. When ordering, add the rated coil voltage to the model number.
Example: G6S-2F 12 VDC
Rated coil voltage
 2. When ordering tape packing, add "-TR" to the model number.
Example: G6S-2F-TR 12 VDC
Tape packing
- Be sure since "-TR" is not part of the relay model number, it is not marked on the relay case.

Model Number Legend

G6S□-□□□-□ □ VDC
1 2 3 4 5

1. Relay Function

- None: Single-side stable
- U: Single-winding latching
- K: Double-winding latching

2. Contact Form

- 2: DPDT

3. Terminal Shape

- None: PCB terminal
- G: Inside-L surface mounting terminal
- F: Outside-L surface mounting terminal

4. Approved Standards

- None: UL/CSA
- Y: EN60950/EN41003

5. Rated Coil Voltage

- 3, 4.5, 5, 12, 24 VDC

Specifications

■ Coil Ratings

Single-side Stable Type (G6S-2, G6S-2F, G6S-2G)

| | | | | | |
|----------------------|-------------------------------|---------|---------|---------|-------------------------------|
| Rated voltage | 3 VDC | 4.5 VDC | 5 VDC | 12 VDC | 24 VDC |
| Rated current | 46.7 mA | 31.0 mA | 28.1 mA | 11.7 mA | 8.3 mA |
| Coil resistance | 64.3 Ω | 145 Ω | 178 Ω | 1,028 Ω | 2,880 Ω |
| Must operate voltage | 75% max. of rated voltage | | | | |
| Must release voltage | 10% min. of rated voltage | | | | |
| Max. voltage | 200% of rated voltage at 23°C | | | | 170% of rated voltage at 23°C |
| Power consumption | Approx. 140 mW | | | | Approx. 200 mW |

- Note:**
1. The rated current and coil resistance are measured at a coil temperature of 23°C with a tolerance of ±10%.
 2. Operating characteristics are measured at a coil temperature of 23°C.
 3. The maximum voltage is the highest voltage that can be imposed on the relay coil.

Single-winding Latching Type (G6SU-2, G6SU-2F, G6SU-2G)

| | | | | | | |
|----------------------------------|-------------------------------|---------|-------|---------|----------------|------|
| Rated voltage | 3 VDC | 4.5 VDC | 5 VDC | 12 VDC | 24 VDC | |
| Rated current | 33.3 mA | 22.2 mA | 20 mA | 8.3 mA | 6.3 mA | |
| Coil resistance | 90 Ω | 203 Ω | 250 Ω | 1,440 Ω | 3,840 Ω | |
| Coil inductance (H) (ref. value) | Armature OFF | 0.108 | 0.27 | 0.36 | 2.12 | 5.80 |
| | Armature ON | 0.069 | 0.14 | 0.18 | 1.14 | 3.79 |
| Must set voltage | 75% max. of rated voltage | | | | | |
| Must reset voltage | 75% max. of rated voltage | | | | | |
| Max. voltage | 180% of rated voltage at 23°C | | | | | |
| Power consumption | Approx. 100 mW | | | | Approx. 150 mW | |

- Note:**
1. The rated current and coil resistance are measured at a coil temperature of 23°C with a tolerance of ±10%.
 2. Operating characteristics are measured at a coil temperature of 23°C.
 3. The maximum voltage is the highest voltage that can be imposed on the relay coil.

Double-winding Latching Type (G6SK-2, G6SK-2F, G6SK-2G)

| | | | | | | | |
|----------------------------------|-------------------------------|--------------|-------|---------|-------------------------------|------|------|
| Rated voltage | 3 VDC | 4.5 VDC | 5 VDC | 12 VDC | 24 VDC | | |
| Rated current | 66.6 mA | 44.4 mA | 40 mA | 16.7 mA | 12.5 mA | | |
| Coil resistance | 45 Ω | 101 Ω | 125 Ω | 720 Ω | 1,920 Ω | | |
| Coil inductance (H) (ref. value) | Set | Armature OFF | 0.045 | 0.12 | 0.14 | 0.60 | 1.98 |
| | | Armature ON | 0.035 | 0.074 | 0.088 | 0.41 | 1.23 |
| | Reset | Armature OFF | 0.032 | 0.082 | 0.098 | 0.46 | 1.34 |
| | | Armature ON | 0.045 | 0.14 | 0.16 | 0.54 | 2.23 |
| Must set voltage | 75% max. of rated voltage | | | | | | |
| Must reset voltage | 75% max. of rated voltage | | | | | | |
| Max. voltage | 170% of rated voltage at 23°C | | | | 140% of rated voltage at 23°C | | |
| Power consumption | Approx. 200 mW | | | | Approx. 300 mW | | |

- Note:**
1. The rated current and coil resistance are measured at a coil temperature of 23°C with a tolerance of ±10%.
 2. Operating characteristics are measured at a coil temperature of 23°C.
 3. The maximum voltage is the highest voltage that can be imposed on the relay coil.

Single-side Stable EN60950/EN41003 Approved Type (G6S-2-Y, G6S-2F-Y, G6S-2G-Y)

| | | | |
|----------------------|-------------------------------|--------------|-------------------------------|
| Rated voltage | 5 VDC | 12 VDC | 24 VDC |
| Rated current | 40 mA | 16.7 mA | 9.6 mA |
| Coil resistance | 125 Ω | 720 Ω | 2,504 Ω |
| Must operate voltage | 75% max. of rated voltage | | |
| Must release voltage | 10% min. of rated voltage | | |
| Max. voltage | 170% of rated voltage at 23°C | | 170% of rated voltage at 23°C |
| Power consumption | Approx. 200 mW | | Approx. 230 mW |

- Note:**
1. The rated current and coil resistance are measured at a coil temperature of 23°C with a tolerance of $\pm 10\%$.
 2. Operating characteristics are measured at a coil temperature of 23°C.
 3. The maximum voltage is the highest voltage that can be imposed on the relay coil.

■ Contact Ratings

| | |
|---|-----------------------------------|
| Load | Resistive load ($\cos\phi = 1$) |
| Rated load | 0.5 A at 125 VAC; 2 A at 30 VDC |
| Contact material | Ag (Au-Alloy) |
| Rated carry current | 2 A |
| Max. switching voltage | 250 VAC, 220 VDC |
| Max. switching current | 2 A |
| Max. switching power | 62.5 VA, 60 W |
| Failure rate (reference value) (See note.) | 10 μ A at 10 mVDC |

- Note:** P level: $\lambda_{60} = 0.1 \times 10^{-6}$ /operation
This value was measured at a switching frequency of 120 operations/min and the criterion of contact resistance is 50 Ω . This value may vary depending on the operating environment. Always double-check relay suitability under actual operating conditions.

■ Characteristics

| | |
|-------------------------------------|---|
| Contact resistance (See note 1.) | 75 m Ω max. |
| Operate (set) time (See note 2.) | 4 ms max. (approx. 2.5 ms; latching type: approx. 2 ms) |
| Release (reset) time (See note 2.) | 4 ms max. (approx. 1.5 ms; latching type: approx. 2 ms) |
| Bounce time | Operate: Approx. 0.5 ms Release: Approx. 0.5 ms Set/Reset: Approx. 0.5 ms |
| Max. operating frequency | Mechanical: 36,000 operations/hr Electrical: 1,800 operations/hr (under rated load) |
| Insulation resistance (See note 3.) | 1,000 M Ω min. (at 500 VDC) |
| Dielectric strength | 2,000 VAC, 50/60 Hz for 1 min between coil and contacts 1,000 VAC, 50/60 Hz for 1 min between coil and contacts (double-winding latching) 1,500 VAC, 50/60 Hz for 1 min between contacts of different polarity 1,000 VAC, 50/60 Hz for 1 min between contacts of same polarity 500 VAC, 50/60 Hz for 1 min between set and reset coil (double-winding latching) |
| Impulse withstand voltage | 2,500 V (2 x 10 μ s) between coil and contacts 1,500 V (10 x 160 μ s) between coil and contacts (double-winding latching) 2,500 V (2 x 10 μ s) between contacts of different polarity 1,500 V (10 x 160 μ s) between contacts of same polarity (conforms to FCC Part 68) |
| Vibration resistance | Destruction: 10 to 55 to 10 Hz, 2.5-mm single amplitude (5-mm double amplitude) Malfunction: 10 to 55 to 10 Hz, 1.65-mm single amplitude (3.3-mm double amplitude) |
| Shock resistance | Destruction: 1,000 m/s ² (approx. 100G) Malfunction: 750 m/s ² (approx. 75G) |
| Endurance | Mechanical: 100,000,000 operations min. (at 36,000 operations/hr) Electrical: 100,000 operations min. (2 A at 30 VDC, resistive load: 1,200 operations/hr) 100,000 operations min. (0.5 A at 125 VAC, resistive load) |
| Ambient temperature | Operating: -40°C to 85°C (with no icing), -40°C to 70°C (double-winding latching, 24 VDC) |
| Ambient humidity | Operating: 5% to 85% |
| Weight | Approx. 2 g |

Note: The above values are initial values.

- Note:**
1. The contact resistance was measured with 10 mA at 1 VDC with a voltage drop method.
 2. Values in parentheses are actual values.
 3. The insulation resistance was measured with a 500-VDC megohmmeter applied to the same parts as those used for checking the dielectric strength (except between the set and reset coil).

■ Approved Standards

UL1950 (File No. E41515)/CSA C22.2 No.950 (File No. LR31928)

| Model | Contact form | Coil ratings | Contact ratings |
|---|--------------|---------------|---|
| G6S-2, G6S-2F, G6S-2G | DPDT | 1.5 to 48 VDC | 2 A, 30 VDC 0.3 A, 110 VDC 0.5 A, 125 VAC |
| G6SU2, G6SK-2, G6SU-2F, G6SU2G, G6SK-2F, G6SK-2G | | 1.5 to 24 VDC | |

EN60950/EN41003

| Model | Contact form | Isolation category | Voltage |
|-----------------------------|--------------|-------------------------|---------|
| G6S-2-Y, G6S-2G-Y, G6S-2F-Y | DPDT | Supplementary Isolation | 250 VAC |

Engineering Data

Maximum Switching Power

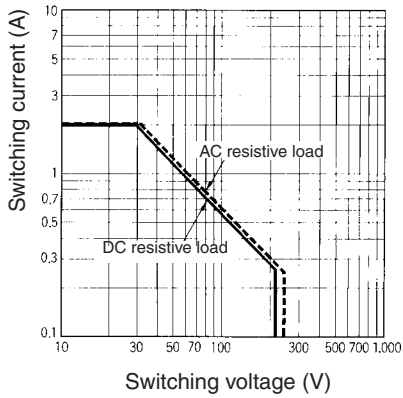

Ambient Temperature vs. Maximum Coil Voltage Single-side Stable

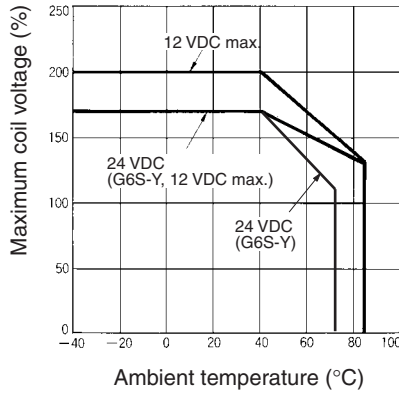

Single-winding Latching Double-winding Latching

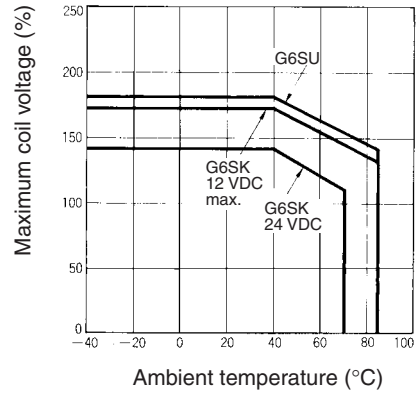

Note: The maximum coil voltage refers to the maximum value in a varying range of operating power voltage, not a continuous voltage.

Reference Data

Ambient Temperature vs. Switching Current Single-side Stable

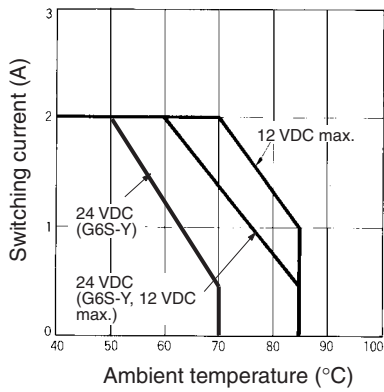

Single-winding Latching Double-winding Latching

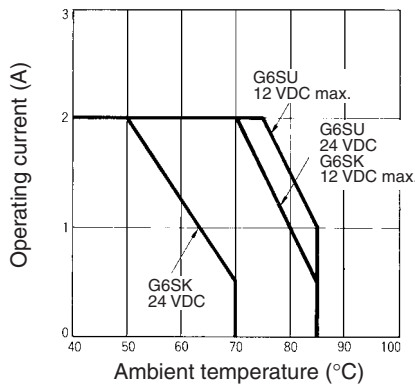

Recommended Soldering Time vs. Surface PCB Temperature

(1) IRS Method (Mounting Solder: Lead)

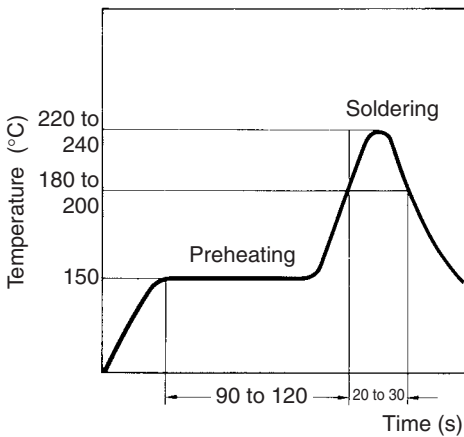

(2) IRS Method (Mounting Solder: Lead-free)

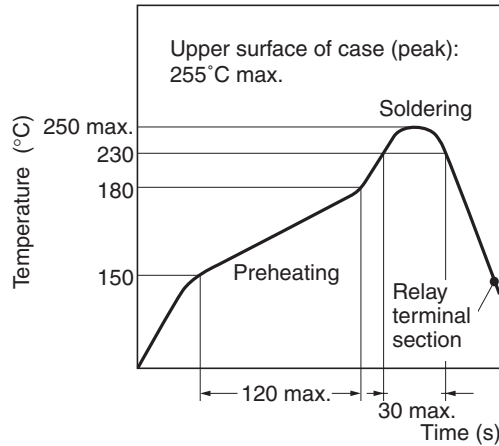

Note: The temperature profile indicates the temperature of the relay terminal section.

Dimensions

Note: All units are in millimeters unless otherwise indicated.

Single-side Stable

G6S-2, G6S-2-Y

Tolerance: ± 0.3

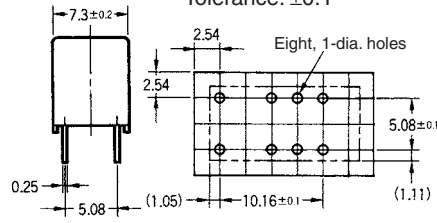
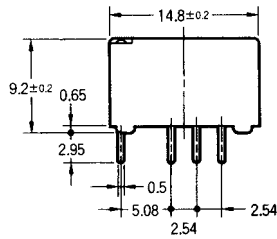
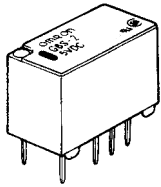

Terminal Arrangement/ Internal Connections (Bottom View)

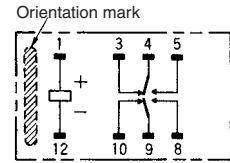

G6S-2F, G6S-2F-Y

Tolerance: ± 0.3

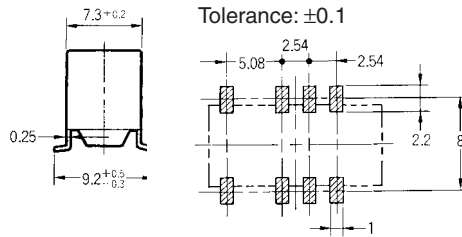
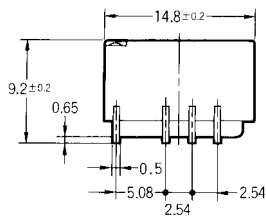
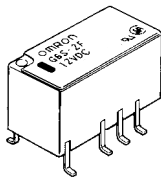

Terminal Arrangement/ Internal Connections (Top View)

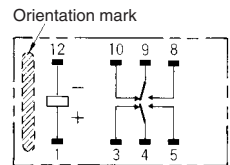

G6S-2G, G6S-2G-Y

Tolerance: ± 0.3

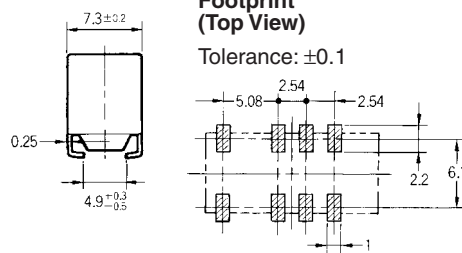
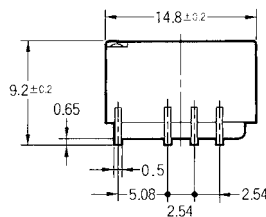
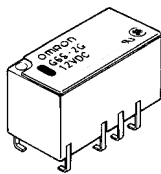

Terminal Arrangement/ Internal Connections (Top View)

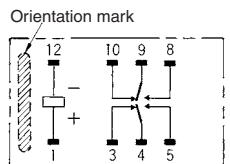

Single-winding Latching

G6SU-2

Tolerance: ± 0.3

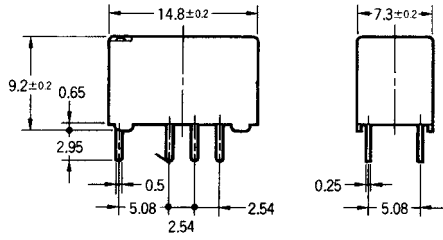
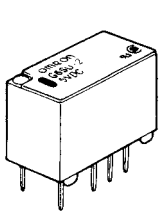

Footprint (Bottom View)

Tolerance: ± 0.1

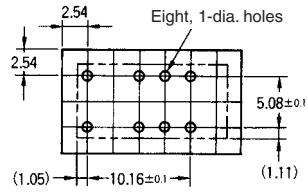

Terminal Arrangement/ Internal Connections (Bottom View)

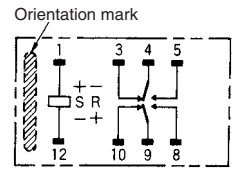

G6SU-2F

Tolerance: ± 0.3

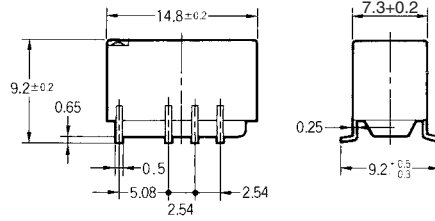
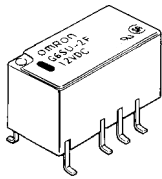

Footprint (Top View)

Tolerance: ± 0.1

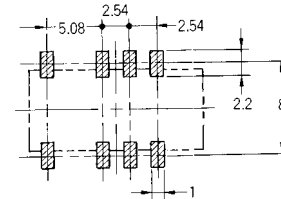

Terminal Arrangement/ Internal Connections (Top View)

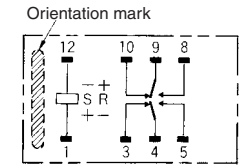

G6SU-2G

Tolerance: ± 0.3

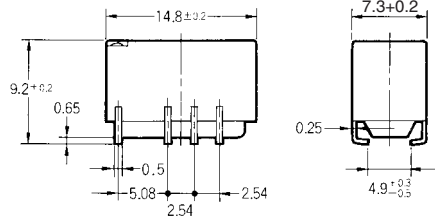
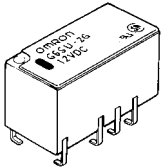

Footprint (Top View)

Tolerance: ± 0.1

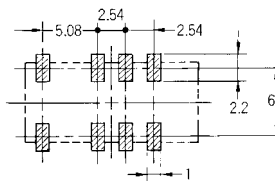

Terminal Arrangement/ Internal Connections (Top View)

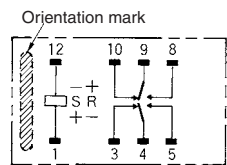

Double-winding Latching

G6SK-2

Tolerance: ± 0.3

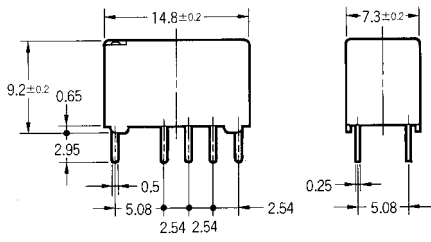
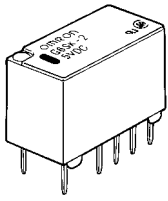

Footprint (Bottom View)

Tolerance: ± 0.1

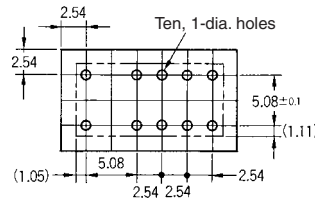

Terminal Arrangement/ Internal Connections (Bottom View)

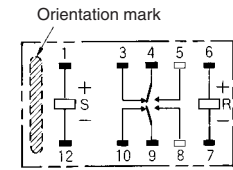

G6SK-2F

Tolerance: ± 0.3

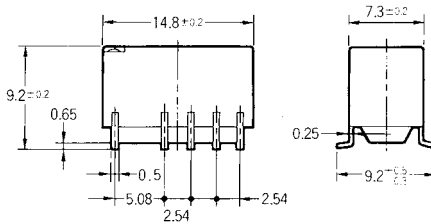
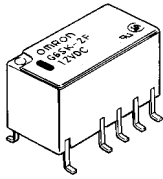

Footprint (Top View)

Tolerance: ± 0.1

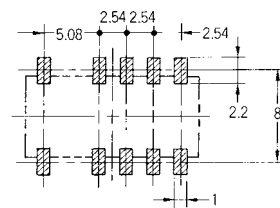

Terminal Arrangement/ Internal Connections (Top View)

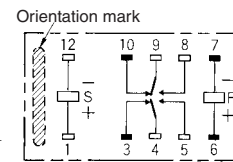

G6SK-2G

Tolerance: ± 0.3

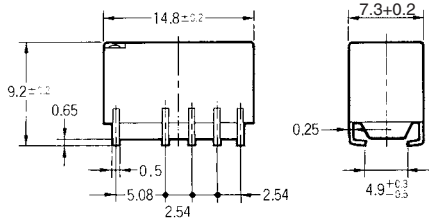
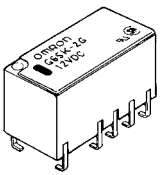

Footprint (Top View)

Tolerance: ± 0.1

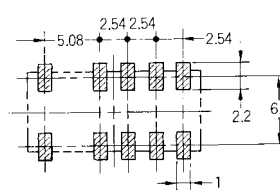

Terminal Arrangement/ Internal Connections (Top View)

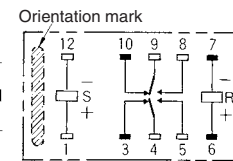

■ Tape Packing

When ordering, add “-TR” before the rated coil voltage for tape packing.

Tape type: TE2416R (Refer to EIAJ)

Reel type: R24E (Refer to EIAJ)

Relays per reel: 400

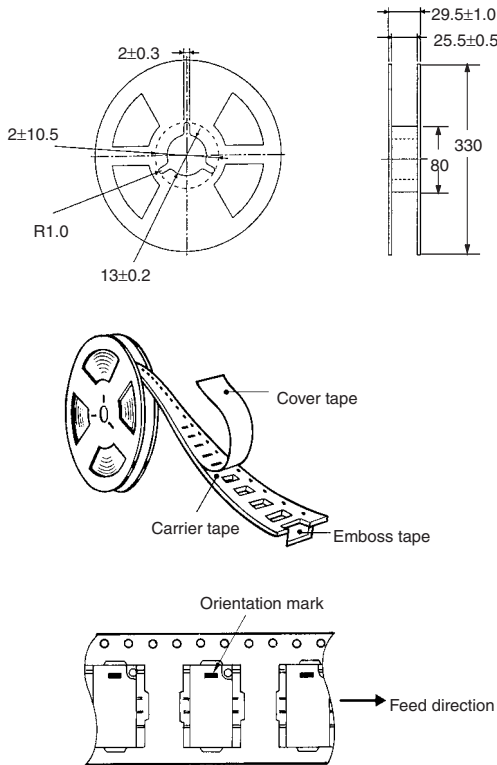

G6S-2F, G6SU-2F, G6SK-2F, G6S-2F-Y

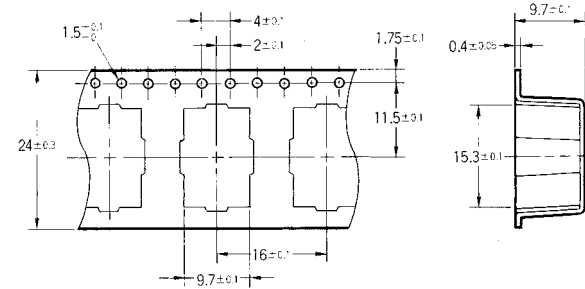

G6S-2G, G6SU-2G, G6SK-2G, G6S-2G-Y

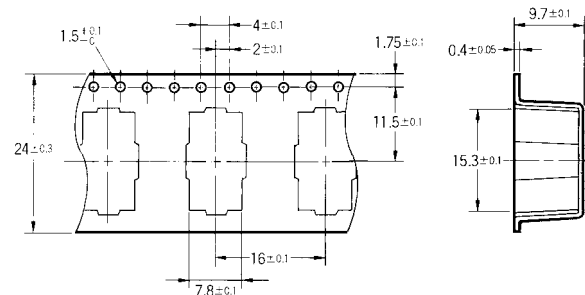

Precautions

Use a DC power supply with 5% or less ripple factor to operate the coil.

Do not use the G6S where subject to strong external magnetic fields.

Do not use the G6S where subject to magnetic particles or excessive amounts of dust.

Do not reverse the polarity of the coil (+, -).

Latching types are delivered in the reset position. We recommend that a reset voltage be applied in advance to start operation.

Do not drop the G6S or otherwise subject it to excessive shock.

Remove the relay from the packing immediately prior to usage.

■ Precautions

Long-term Continuously ON Contacts

Using the Relay in a circuit where the Relay will be ON continuously for long periods (without switching) can lead to unstable contacts because the heat generated by the coil itself will affect the insulation, causing a film to develop on the contact surfaces. We recommend using a latching relay (magnetic-holding relay) in this kind of circuit. If a single-side stable model must be used in this kind of circuit, we recommend using a fail-safe circuit design that provides protection against contact failure or coil burnout.

Relay Handling

Use the Relay as soon as possible after opening the moisture-proof package. If the Relay is left for a long time after opening the moisture-proof package, the appearance may suffer and seal failure may occur after the solder mounting process. To store the Relay after opening the moisture-proof package, place it into the original package and sealed the package with adhesive tape.

When washing the product after soldering the Relay to a PCB, use a water-based solvent or alcohol-based solvent, and keep the solvent temperature to less than 40°C. Do not put the Relay in a cold cleaning bath immediately after soldering.

G6S (K) (-U) -2 Soldering

- Soldering temperature: Approx. 250°C (At 260°C if the DWS method is used.)
- Soldering time: Approx. 5 s max. (Approx. 2 s for the first time and approx. 3 s for the second time if the DWS method is used.)
- Be sure to adjust the level of the molten solder so that the solder will not overflow onto the PCB.

Claw Securing Force During Automatic Mounting

During automatic insertion of Relays, be sure to set the securing force of each claw to the following so that the Relay's characteristics will be maintained.

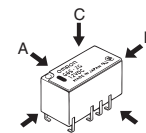

Dimension A: 1.96 N max.
Dimension B: 4.90 N max.
Dimension C: 1.96 N max.

ALL DIMENSIONS SHOWN ARE IN MILLIMETERS.

To convert millimeters into inches, multiply by 0.03937. To convert grams into ounces, multiply by 0.03527.

Cat. No. K093-E1-05 **In the interest of product improvement, specifications are subject to change without notice.**

OMRON RELAY & DEVICES Corporation

C & C Power Relay Division

Marketing Department

1110, Sugi, Yamaga-city, Kumamoto-Pref., 861-0596 Japan

Tel: (81)968-44-4160/Fax: (81)968-44-4107

Printed in Japan
0306-0.4M (0595) (A)