

Overview

Polyethylene naphthalate (PEN) film capacitor for surface mounting. Encapsulation in self-extinguishing material meeting the requirements of UL 94 V-0.

Applications

Typical applications include bypassing and signal coupling. GMC is a general purpose series designed for the highest reliability.

Benefits

- Rated voltage: 50 – 630 VDC
- Rated voltage: 30 – 300 VAC
- Capacitance range: 0.001 – 5.6 μ F
- EIA size: 2220 – 6560
- Capacitance tolerance: \pm 5%, \pm 10%, other tolerances on request
- Climatic category: 55/125/56
- RoHS Compliant and lead-free terminations
- Operating temperature range of -55°C to +125°C

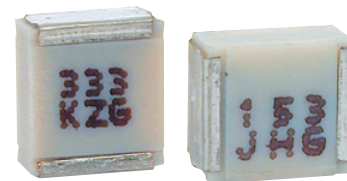

Legacy Part Number System

GMC	5.7	102	K	50	J31	TR12
Series	Chip Length (mm)	Capacitance Code (pF)	Capacitance Tolerance	Rated Voltage (VDC)	Size Code	Packaging Code
Metallized PEN	5.7 7.3 10.2 12.7 16.5	First two digits indicate the two most significant digits of the capacitance value in picofarads. The third digit is the number of following zeros.	J = \pm 5% K = \pm 10% Other tolerances on request	50 63 100 250 400 630	See Dimension Table	See Ordering Options Table

New KEMET Part Number System

F	115	P	L	102	K	050	V
Capacitor Class	Series	Chip Size	Size Code	Capacitance Code (pF)	Capacitance Tolerance	Rated Voltage (VDC)	Packaging Code
F = Film	Metallized PEN	P = 2220 S = 2824 W = 4036 Y = 5045 Z = 6560	See Dimension Table	First two digits indicate the two most significant digits of the capacitance value in picofarads. The third digit is the number of following zeros.	J = \pm 5% K = \pm 10% Other tolerances on request	050 = 50 063 = 63 100 = 100 250 = 250 400 = 400 630 = 630	See Ordering Options Table

Ordering Options Table

Chip Size (EIA)	Packaging Type	KEMET Packaging Code	Legacy Packaging Code
2220	Standard Packaging Options		
	Tape & Reel (Standard Reel)	V	TR12
	Bulk (Bag)	A	BULK
2824	Standard Packaging Options		
	Tape & Reel (Standard Reel)	V	TR12
	Bulk (Bag)	A	BULK
4036	Standard Packaging Options		
	Tape & Reel (Standard Reel)	V	TR16
	Bulk (Bag)	A	BULK
	Other Packaging Options		
	Tape & Reel (Vertical Orientation Standard Reel)	Y	TV24
5045	Standard Packaging Options		
	Tape & Reel (Standard Reel)	V	TR24
	Bulk (Bag)	A	BULK
	Other Packaging Options		
	Tape & Reel (Vertical Orientation Standard Reel)	Y	TV24
6560	Standard Packaging Options		
	Tape & Reel (Standard Reel)	V	TR24
	Bulk (Bag)	A	BULK
	Other Packaging Options		
	Tape & Reel (Vertical Orientation Standard Reel)	Y	TV44

Dimensions – Millimeters

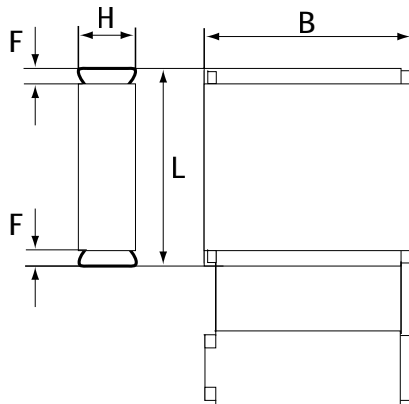

KEMET Size Code	Legacy Size Code	Chip Size (EIA)	B		H		L		F	
			Nominal	Tolerance	Nominal	Tolerance	Nominal	Tolerance	Nominal	Tolerance
PL	J31	2220	5.0	+/-0.2	2.5	+/-0.2	5.7	+/-0.2	0.5	Nominal
PP	J33	2220	5.0	+/-0.2	3.0	+/-0.2	5.7	+/-0.2	0.5	Nominal
PU	J35	2220	5.0	+/-0.2	4.0	+/-0.2	5.7	+/-0.2	0.5	Nominal
SG	K31	2824	6.0	+/-0.2	2.5	+/-0.2	7.3	+/-0.2	0.5	Nominal
SL	K33	2824	6.0	+/-0.2	3.0	+/-0.2	7.3	+/-0.2	0.5	Nominal
SP	K35	2824	6.0	+/-0.2	3.5	+/-0.2	7.3	+/-0.2	0.5	Nominal
ST	K37	2824	6.0	+/-0.2	4.5	+/-0.2	7.3	+/-0.2	0.5	Nominal
WP	A31	4036	9.1	+/-0.2	5.5	+/-0.2	10.2	+/-0.2	0.5	Nominal
YR	B31	5045	11.5	+/-0.2	6.5	+/-0.2	12.7	+/-0.2	0.5	Nominal
ZS	C31	6560	15	+/-0.2	7.0	+/-0.2	16.5	+/-0.2	0.5	Nominal

Environmental Compliance

All KEMET surface mount capacitors are RoHS Compliant.



RoHS Compliant

Performance Characteristics

Rated Voltage (VDC)	50	63	100	250	400	630
Rated Voltage (VAC)	30	40	63	160	200	300
Capacitance Range (µF)	0.001 – 5.6	0.001 – 4.7	0.001 – 2.2	0.001 – 0.68	0.001 – 0.33	0.022-0.15
Chip Size (EIA)	2220 – 6560					
Capacitance Tolerance	±5%, ±10%, other tolerances on request					
Category Temperature Range	-55°C to +125°C					
Rated Temperature	+100°C					
Voltage Derating	The rated voltage should be decreased with 1.25%/°C from +100°C to +125°C and 1.5%/°C from +125°C to 175°C					
Climatic Category	55/125/56					
Test Voltage	1.6 x V _R , 60 seconds					
Insulation Resistance	Measured at +20°C According to IEC 60384-19					
	Minimum Value Between Terminals					
		C ≤ 0.33 µF		C > 0.33 µF		
	V _R ≤ 100	10,000 MΩ		3,000 MΩ • µF		
V _R > 100	30,000 MΩ		10,000 MΩ • µF			
Dissipation Factor	Maximum Values at +23°C					
		C ≤ 0.1 µF	0.1 < C ≤ 1 µF		C > 1 µF	
	1 kHz	0.6%	0.6%		0.6%	
	10 kHz	1.0%	1.0%		1.0%	
	100 kHz	2.0%	2.5%			
Pulse Rise Time	The capacitors can withstand an unlimited number of pulses with a dV/dt according to Table 1. For voltages (V) lower than the rated voltage (V _R), the specified dV/dt can be multiplied by V _R /V.					

Capacitance vs. Temperature

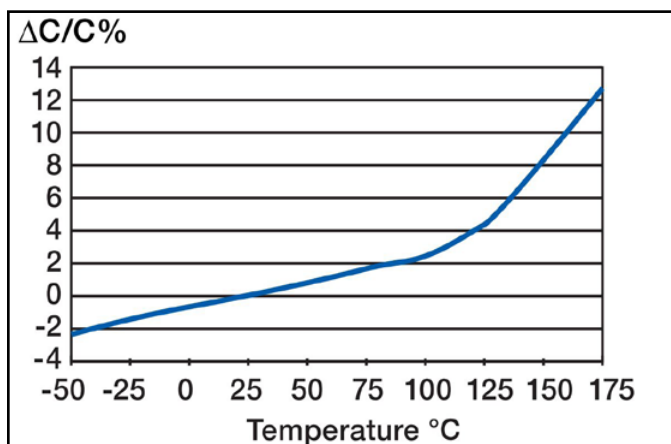

Dissipation Factor vs. Temperature

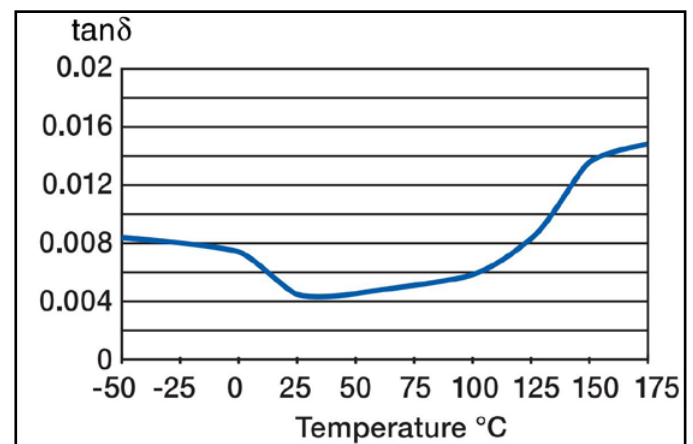

Table 1 – Ratings & Part Number Reference

VDC	VAC	Cap Value (µF)	Size Code (New/Legacy)	Dimensions in mm			Chip Size	dV/dt (V/µs)	New KEMET Part Number	Legacy Part Number
				B	H	L				
50	30	0.0010	PL/J31	5.0	2.5	5.7	2220	40	F115PL102(1)050(2)	GMC5.7102(1)50J31(2)
50	30	0.0012	PL/J31	5.0	2.5	5.7	2220	40	F115PL122(1)050(2)	GMC5.7122(1)50J31(2)
50	30	0.0015	PL/J31	5.0	2.5	5.7	2220	40	F115PL152(1)050(2)	GMC5.7152(1)50J31(2)
50	30	0.0018	PL/J31	5.0	2.5	5.7	2220	40	F115PL182(1)050(2)	GMC5.7182(1)50J31(2)
50	30	0.0022	PL/J31	5.0	2.5	5.7	2220	40	F115PL222(1)050(2)	GMC5.7222(1)50J31(2)
50	30	0.0027	PL/J31	5.0	2.5	5.7	2220	40	F115PL272(1)050(2)	GMC5.7272(1)50J31(2)
50	30	0.0033	PL/J31	5.0	2.5	5.7	2220	40	F115PL332(1)050(2)	GMC5.7332(1)50J31(2)
50	30	0.0039	PL/J31	5.0	2.5	5.7	2220	40	F115PL392(1)050(2)	GMC5.7392(1)50J31(2)
50	30	0.0047	PL/J31	5.0	2.5	5.7	2220	40	F115PL472(1)050(2)	GMC5.7472(1)50J31(2)
50	30	0.0056	PL/J31	5.0	2.5	5.7	2220	40	F115PL562(1)050(2)	GMC5.7562(1)50J31(2)
50	30	0.0068	PL/J31	5.0	2.5	5.7	2220	40	F115PL682(1)050(2)	GMC5.7682(1)50J31(2)
50	30	0.0082	PL/J31	5.0	2.5	5.7	2220	40	F115PL822(1)050(2)	GMC5.7822(1)50J31(2)
50	30	0.010	PL/J31	5.0	2.5	5.7	2220	40	F115PL103(1)050(2)	GMC5.7103(1)50J31(2)
50	30	0.012	PL/J31	5.0	2.5	5.7	2220	40	F115PL123(1)050(2)	GMC5.7123(1)50J31(2)
50	30	0.015	PL/J31	5.0	2.5	5.7	2220	30	F115PL153(1)050(2)	GMC5.7153(1)50J31(2)
50	30	0.018	PL/J31	5.0	2.5	5.7	2220	30	F115PL183(1)050(2)	GMC5.7183(1)50J31(2)
50	30	0.022	PL/J31	5.0	2.5	5.7	2220	30	F115PL223(1)050(2)	GMC5.7223(1)50J31(2)
50	30	0.027	PL/J31	5.0	2.5	5.7	2220	30	F115PL273(1)050(2)	GMC5.7273(1)50J31(2)
50	30	0.033	PL/J31	5.0	2.5	5.7	2220	20	F115PL333(1)050(2)	GMC5.7333(1)50J31(2)
50	30	0.039	PL/J31	5.0	2.5	5.7	2220	20	F115PL393(1)050(2)	GMC5.7393(1)50J31(2)
50	30	0.047	PL/J31	5.0	2.5	5.7	2220	20	F115PL473(1)050(2)	GMC5.7473(1)50J31(2)
50	30	0.056	PL/J31	5.0	2.5	5.7	2220	20	F115PL563(1)050(2)	GMC5.7563(1)50J31(2)
50	30	0.068	PL/J31	5.0	2.5	5.7	2220	20	F115PL683(1)050(2)	GMC5.7683(1)50J31(2)
50	30	0.082	PL/J31	5.0	2.5	5.7	2220	20	F115PL823(1)050(2)	GMC5.7823(1)50J31(2)
50	30	0.10	PL/J31	5.0	2.5	5.7	2220	20	F115PL104(1)050(2)	GMC5.7104(1)50J31(2)
50	30	0.12	PPI/J33	5.0	3.0	5.7	2220	20	F115PP124(1)050(2)	GMC5.7124(1)50J33(2)
50	30	0.15	PU/J35	5.0	4.0	5.7	2220	20	F115PU154(1)050(2)	GMC5.7154(1)50J35(2)
50	30	0.18	PU/J35	5.0	4.0	5.7	2220	20	F115PU184(1)050(2)	GMC5.7184(1)50J35(2)
50	30	0.022	WPI/A31	9.1	5.5	10.2	4036	40	F115WP223(1)050(2)	GMC10.2223(1)50A31(2)
50	30	0.027	WPI/A31	9.1	5.5	10.2	4036	40	F115WP273(1)050(2)	GMC10.2273(1)50A31(2)
50	30	0.033	WPI/A31	9.1	5.5	10.2	4036	40	F115WP333(1)050(2)	GMC10.2333(1)50A31(2)
50	30	0.039	WPI/A31	9.1	5.5	10.2	4036	40	F115WP393(1)050(2)	GMC10.2393(1)50A31(2)
50	30	0.047	WPI/A31	9.1	5.5	10.2	4036	30	F115WP473(1)050(2)	GMC10.2473(1)50A31(2)
50	30	0.056	WPI/A31	9.1	5.5	10.2	4036	30	F115WP563(1)050(2)	GMC10.2563(1)50A31(2)
50	30	0.068	WPI/A31	9.1	5.5	10.2	4036	30	F115WP683(1)050(2)	GMC10.2683(1)50A31(2)
50	30	0.082	WPI/A31	9.1	5.5	10.2	4036	30	F115WP823(1)050(2)	GMC10.2823(1)50A31(2)
50	30	0.10	WPI/A31	9.1	5.5	10.2	4036	30	F115WP104(1)050(2)	GMC10.2104(1)50A31(2)
50	30	0.12	WPI/A31	9.1	5.5	10.2	4036	30	F115WP124(1)050(2)	GMC10.2124(1)50A31(2)
50	30	0.15	WPI/A31	9.1	5.5	10.2	4036	20	F115WP154(1)050(2)	GMC10.2154(1)50A31(2)
50	30	0.18	WPI/A31	9.1	5.5	10.2	4036	20	F115WP184(1)050(2)	GMC10.2184(1)50A31(2)
50	30	0.22	WPI/A31	9.1	5.5	10.2	4036	20	F115WP224(1)050(2)	GMC10.2224(1)50A31(2)
50	30	0.27	WPI/A31	9.1	5.5	10.2	4036	20	F115WP274(1)050(2)	GMC10.2274(1)50A31(2)
50	30	0.33	WPI/A31	9.1	5.5	10.2	4036	20	F115WP334(1)050(2)	GMC10.2334(1)50A31(2)
50	30	0.39	WPI/A31	9.1	5.5	10.2	4036	10	F115WP394(1)050(2)	GMC10.2394(1)50A31(2)
50	30	0.47	WPI/A31	9.1	5.5	10.2	4036	10	F115WP474(1)050(2)	GMC10.2474(1)50A31(2)
50	30	0.56	WPI/A31	9.1	5.5	10.2	4036	10	F115WP564(1)050(2)	GMC10.2564(1)50A31(2)
50	30	0.68	WPI/A31	9.1	5.5	10.2	4036	10	F115WP684(1)050(2)	GMC10.2684(1)50A31(2)
50	30	0.82	WPI/A31	9.1	5.5	10.2	4036	10	F115WP824(1)050(2)	GMC10.2824(1)50A31(2)
50	30	1.0	WPI/A31	9.1	5.5	10.2	4036	10	F115WP105(1)050(2)	GMC10.2105(1)50A31(2)
50	30	1.2	WPI/A31	9.1	5.5	10.2	4036	10	F115WP125(1)050(2)	GMC10.2125(1)50A31(2)
50	30	1.5	YR/B31	11.5	6.5	12.7	5045	8	F115YR155(1)050(2)	GMC12.7155(1)50B31(2)
50	30	1.8	YR/B31	11.5	6.5	12.7	5045	8	F115YR185(1)050(2)	GMC12.7185(1)50B31(2)
50	30	2.2	YR/B31	11.5	6.5	12.7	5045	8	F115YR225(1)050(2)	GMC12.7225(1)50B31(2)
50	30	2.7	YR/B31	11.5	6.5	12.7	5045	8	F115YR275(1)050(2)	GMC12.7275(1)50B31(2)
50	30	3.0	YR/B31	11.5	6.5	12.7	5045	8	F115YR305(1)050(2)	GMC12.7305(1)50B31(2)
50	30	3.9	ZS/C31	15.0	7.0	16.5	6560	5	F115ZS395(1)050(2)	GMC16.5395(1)50C31(2)
50	30	4.7	ZS/C31	15.0	7.0	16.5	6560	5	F115ZS475(1)050(2)	GMC16.5475(1)50C31(2)
50	30	5.6	ZS/C31	15.0	7.0	16.5	6560	5	F115ZS565(1)050(2)	GMC16.5565(1)50C31(2)
63	40	0.0010	SG/K31	6.0	2.5	7.3	2824	50	F115SG102(1)063(2)	GMC7.3102(1)63K31(2)
VDC	VAC	Capacitance Value (µF)	Size Code (New/Legacy)	B (mm)	H (mm)	L (mm)	Chip Size	dV/dt (V/µs)	New KEMET Part Number	Legacy Part Number

(1) J = ±5%, K = ±10%, other tolerances on request.

(2) Insert ordering code for lead type and packaging. See Ordering Options Table for available options.

Table 1 – Ratings & Part Number Reference cont'd

VDC	VAC	Cap Value (µF)	Size Code (New/Legacy)	Dimensions in mm			Chip Size	dV/dt (V/µs)	New KEMET Part Number	Legacy Part Number
				B	H	L				
63	40	0.0012	SG/K31	6.0	2.5	7.3	2824	50	F115SG122(1)063(2)	GMC7.3122(1)63K31(2)
63	40	0.0015	SG/K31	6.0	2.5	7.3	2824	50	F115SG152(1)063(2)	GMC7.3152(1)63K31(2)
63	40	0.0018	SG/K31	6.0	2.5	7.3	2824	50	F115SG182(1)063(2)	GMC7.3182(1)63K31(2)
63	40	0.0022	SG/K31	6.0	2.5	7.3	2824	50	F115SG222(1)063(2)	GMC7.3222(1)63K31(2)
63	40	0.0027	SG/K31	6.0	2.5	7.3	2824	50	F115SG272(1)063(2)	GMC7.3272(1)63K31(2)
63	40	0.0033	SG/K31	6.0	2.5	7.3	2824	50	F115SG332(1)063(2)	GMC7.3332(1)63K31(2)
63	40	0.0039	SG/K31	6.0	2.5	7.3	2824	50	F115SG392(1)063(2)	GMC7.3392(1)63K31(2)
63	40	0.0047	SG/K31	6.0	2.5	7.3	2824	50	F115SG472(1)063(2)	GMC7.3472(1)63K31(2)
63	40	0.0056	SG/K31	6.0	2.5	7.3	2824	50	F115SG562(1)063(2)	GMC7.3562(1)63K31(2)
63	40	0.0068	SG/K31	6.0	2.5	7.3	2824	40	F115SG682(1)063(2)	GMC7.3682(1)63K31(2)
63	40	0.0082	SG/K31	6.0	2.5	7.3	2824	40	F115SG822(1)063(2)	GMC7.3822(1)63K31(2)
63	40	0.010	SG/K31	6.0	2.5	7.3	2824	40	F115SG103(1)063(2)	GMC7.3103(1)63K31(2)
63	40	0.012	SG/K31	6.0	2.5	7.3	2824	40	F115SG123(1)063(2)	GMC7.3123(1)63K31(2)
63	40	0.015	SG/K31	6.0	2.5	7.3	2824	40	F115SG153(1)063(2)	GMC7.3153(1)63K31(2)
63	40	0.018	SG/K31	6.0	2.5	7.3	2824	40	F115SG183(1)063(2)	GMC7.3183(1)63K31(2)
63	40	0.022	SG/K31	6.0	2.5	7.3	2824	30	F115SG223(1)063(2)	GMC7.3223(1)63K31(2)
63	40	0.027	SG/K31	6.0	2.5	7.3	2824	30	F115SG273(1)063(2)	GMC7.3273(1)63K31(2)
63	40	0.033	SG/K31	6.0	2.5	7.3	2824	30	F115SG333(1)063(2)	GMC7.3333(1)63K31(2)
63	40	0.039	SG/K31	6.0	2.5	7.3	2824	30	F115SG393(1)063(2)	GMC7.3393(1)63K31(2)
63	40	0.047	SG/K31	6.0	2.5	7.3	2824	30	F115SG473(1)063(2)	GMC7.3473(1)63K31(2)
63	40	0.056	SG/K31	6.0	2.5	7.3	2824	30	F115SG563(1)063(2)	GMC7.3563(1)63K31(2)
63	40	0.068	SG/K31	6.0	2.5	7.3	2824	20	F115SG683(1)063(2)	GMC7.3683(1)63K31(2)
63	40	0.082	SG/K31	6.0	2.5	7.3	2824	20	F115SG823(1)063(2)	GMC7.3823(1)63K31(2)
63	40	0.10	SG/K31	6.0	2.5	7.3	2824	20	F115SG104(1)063(2)	GMC7.3104(1)63K31(2)
63	40	0.12	SG/K31	6.0	2.5	7.3	2824	20	F115SG124(1)063(2)	GMC7.3124(1)63K31(2)
63	40	0.15	SG/K31	6.0	2.5	7.3	2824	20	F115SG154(1)063(2)	GMC7.3154(1)63K31(2)
63	40	0.18	SL/K33	6.0	3.0	7.3	2824	20	F115SL184(1)063(2)	GMC7.3184(1)63K33(2)
63	40	0.22	SL/K33	6.0	3.0	7.3	2824	20	F115SL224(1)063(2)	GMC7.3224(1)63K33(2)
63	40	0.27	SP/K35	6.0	3.5	7.3	2824	20	F115SP274(1)063(2)	GMC7.3274(1)63K35(2)
63	40	0.33	SP/K35	6.0	3.5	7.3	2824	20	F115SP334(1)063(2)	GMC7.3334(1)63K35(2)
63	40	0.39	ST/K37	6.0	4.5	7.3	2824	20	F115ST394(1)063(2)	GMC7.3394(1)63K37(2)
63	40	0.022	WPI/A31	9.1	5.5	10.2	4036	40	F115WP223(1)063(2)	GMC10.2223(1)63A31(2)
63	40	0.027	WPI/A31	9.1	5.5	10.2	4036	40	F115WP273(1)063(2)	GMC10.2273(1)63A31(2)
63	40	0.033	WPI/A31	9.1	5.5	10.2	4036	40	F115WP333(1)063(2)	GMC10.2333(1)63A31(2)
63	40	0.039	WPI/A31	9.1	5.5	10.2	4036	40	F115WP393(1)063(2)	GMC10.2393(1)63A31(2)
63	40	0.047	WPI/A31	9.1	5.5	10.2	4036	30	F115WP473(1)063(2)	GMC10.2473(1)63A31(2)
63	40	0.056	WPI/A31	9.1	5.5	10.2	4036	30	F115WP563(1)063(2)	GMC10.2563(1)63A31(2)
63	40	0.068	WPI/A31	9.1	5.5	10.2	4036	30	F115WP683(1)063(2)	GMC10.2683(1)63A31(2)
63	40	0.082	WPI/A31	9.1	5.5	10.2	4036	30	F115WP823(1)063(2)	GMC10.2823(1)63A31(2)
63	40	0.10	WPI/A31	9.1	5.5	10.2	4036	30	F115WP104(1)063(2)	GMC10.2104(1)63A31(2)
63	40	0.12	WPI/A31	9.1	5.5	10.2	4036	30	F115WP124(1)063(2)	GMC10.2124(1)63A31(2)
63	40	0.15	WPI/A31	9.1	5.5	10.2	4036	20	F115WP154(1)063(2)	GMC10.2154(1)63A31(2)
63	40	0.18	WPI/A31	9.1	5.5	10.2	4036	20	F115WP184(1)063(2)	GMC10.2184(1)63A31(2)
63	40	0.22	WPI/A31	9.1	5.5	10.2	4036	20	F115WP224(1)063(2)	GMC10.2224(1)63A31(2)
63	40	0.27	WPI/A31	9.1	5.5	10.2	4036	20	F115WP274(1)063(2)	GMC10.2274(1)63A31(2)
63	40	0.33	WPI/A31	9.1	5.5	10.2	4036	20	F115WP334(1)063(2)	GMC10.2334(1)63A31(2)
63	40	0.39	WPI/A31	9.1	5.5	10.2	4036	10	F115WP394(1)063(2)	GMC10.2394(1)63A31(2)
63	40	0.47	WPI/A31	9.1	5.5	10.2	4036	10	F115WP474(1)063(2)	GMC10.2474(1)63A31(2)
63	40	0.56	WPI/A31	9.1	5.5	10.2	4036	10	F115WP564(1)063(2)	GMC10.2564(1)63A31(2)
63	40	0.68	WPI/A31	9.1	5.5	10.2	4036	10	F115WP684(1)063(2)	GMC10.2684(1)63A31(2)
63	40	0.82	WPI/A31	9.1	5.5	10.2	4036	10	F115WP824(1)063(2)	GMC10.2824(1)63A31(2)
63	40	1.0	YR/B31	11.5	6.5	12.7	5045	8	F115YR105(1)063(2)	GMC12.7105(1)63B31(2)
63	40	1.2	YR/B31	11.5	6.5	12.7	5045	8	F115YR125(1)063(2)	GMC12.7125(1)63B31(2)
63	40	1.5	YR/B31	11.5	6.5	12.7	5045	8	F115YR155(1)063(2)	GMC12.7155(1)63B31(2)
63	40	1.8	ZS/C31	15.0	7.0	16.5	6560	5	F115ZS185(1)063(2)	GMC16.5185(1)63C31(2)
63	40	2.2	ZS/C31	15.0	7.0	16.5	6560	5	F115ZS225(1)063(2)	GMC16.5225(1)63C31(2)
63	40	2.7	ZS/C31	15.0	7.0	16.5	6560	5	F115ZS275(1)063(2)	GMC16.5275(1)63C31(2)
63	40	3.3	ZS/C31	15.0	7.0	16.5	6560	5	F115ZS335(1)063(2)	GMC16.5335(1)63C31(2)
63	40	3.9	ZS/C31	15.0	7.0	16.5	6560	5	F115ZS395(1)063(2)	GMC16.5395(1)63C31(2)
VDC	VAC	Capacitance Value (µF)	Size Code (New/Legacy)	B (mm)	H (mm)	L (mm)	Chip Size	dV/dt (V/µs)	New KEMET Part Number	Legacy Part Number

(1) J = ±5%, K = ±10%, other tolerances on request.

(2) Insert ordering code for lead type and packaging. See Ordering Options Table for available options.

Table 1 – Ratings & Part Number Reference cont'd

VDC	VAC	Cap Value (μ F)	Size Code (New/Legacy)	Dimensions in mm			Chip Size	dV/dt (V/ μ s)	New KEMET Part Number	Legacy Part Number
				B	H	L				
63	40	4.7	ZS/C31	15.0	7.0	16.5	6560	5	F115ZS475(1)063(2)	GMC16.5475(1)63C31(2)
100	63	0.0010	PL/J31	5.0	2.5	5.7	2220	40	F115PL102(1)100(2)	GMC5.7102(1)100J31(2)
100	63	0.0012	PL/J31	5.0	2.5	5.7	2220	40	F115PL122(1)100(2)	GMC5.7122(1)100J31(2)
100	63	0.0015	PL/J31	5.0	2.5	5.7	2220	40	F115PL152(1)100(2)	GMC5.7152(1)100J31(2)
100	63	0.0018	PL/J31	5.0	2.5	5.7	2220	40	F115PL182(1)100(2)	GMC5.7182(1)100J31(2)
100	63	0.0022	PL/J31	5.0	2.5	5.7	2220	40	F115PL222(1)100(2)	GMC5.7222(1)100J31(2)
100	63	0.0027	PL/J31	5.0	2.5	5.7	2220	40	F115PL272(1)100(2)	GMC5.7272(1)100J31(2)
100	63	0.0033	PL/J31	5.0	2.5	5.7	2220	40	F115PL332(1)100(2)	GMC5.7332(1)100J31(2)
100	63	0.0039	PL/J31	5.0	2.5	5.7	2220	40	F115PL392(1)100(2)	GMC5.7392(1)100J31(2)
100	63	0.0047	PL/J31	5.0	2.5	5.7	2220	40	F115PL472(1)100(2)	GMC5.7472(1)100J31(2)
100	63	0.0056	PL/J31	5.0	2.5	5.7	2220	40	F115PL562(1)100(2)	GMC5.7562(1)100J31(2)
100	63	0.0068	PL/J31	5.0	2.5	5.7	2220	40	F115PL682(1)100(2)	GMC5.7682(1)100J31(2)
100	63	0.0082	PL/J31	5.0	2.5	5.7	2220	40	F115PL822(1)100(2)	GMC5.7822(1)100J31(2)
100	63	0.010	PL/J31	5.0	2.5	5.7	2220	40	F115PL103(1)100(2)	GMC5.7103(1)100J31(2)
100	63	0.012	PL/J31	5.0	2.5	5.7	2220	40	F115PL123(1)100(2)	GMC5.7123(1)100J31(2)
100	63	0.015	PL/J31	5.0	2.5	5.7	2220	30	F115PL153(1)100(2)	GMC5.7153(1)100J31(2)
100	63	0.018	PL/J31	5.0	2.5	5.7	2220	30	F115PL183(1)100(2)	GMC5.7183(1)100J31(2)
100	63	0.022	PL/J31	5.0	2.5	5.7	2220	30	F115PL223(1)100(2)	GMC5.7223(1)100J31(2)
100	63	0.027	PP/J33	5.0	3.0	5.7	2220	30	F115PP273(1)100(2)	GMC5.7273(1)100J33(2)
100	63	0.033	PPI/J33	5.0	3.0	5.7	2220	30	F115PP333(1)100(2)	GMC5.7333(1)100J33(2)
100	63	0.039	PU/J35	5.0	4.0	5.7	2220	30	F115PU393(1)100(2)	GMC5.7393(1)100J35(2)
100	63	0.047	PU/J35	5.0	4.0	5.7	2220	30	F115PU473(1)100(2)	GMC5.7473(1)100J35(2)
100	63	0.0010	SG/K31	6.0	2.5	7.3	2824	50	F115SG102(1)100(2)	GMC7.3102(1)100K31(2)
100	63	0.0012	SG/K31	6.0	2.5	7.3	2824	50	F115SG122(1)100(2)	GMC7.3122(1)100K31(2)
100	63	0.0015	SG/K31	6.0	2.5	7.3	2824	50	F115SG152(1)100(2)	GMC7.3152(1)100K31(2)
100	63	0.0018	SG/K31	6.0	2.5	7.3	2824	50	F115SG182(1)100(2)	GMC7.3182(1)100K31(2)
100	63	0.0022	SG/K31	6.0	2.5	7.3	2824	50	F115SG222(1)100(2)	GMC7.3222(1)100K31(2)
100	63	0.0027	SG/K31	6.0	2.5	7.3	2824	50	F115SG272(1)100(2)	GMC7.3272(1)100K31(2)
100	63	0.0033	SG/K31	6.0	2.5	7.3	2824	50	F115SG332(1)100(2)	GMC7.3332(1)100K31(2)
100	63	0.0039	SG/K31	6.0	2.5	7.3	2824	50	F115SG392(1)100(2)	GMC7.3392(1)100K31(2)
100	63	0.0047	SG/K31	6.0	2.5	7.3	2824	50	F115SG472(1)100(2)	GMC7.3472(1)100K31(2)
100	63	0.0056	SG/K31	6.0	2.5	7.3	2824	50	F115SG562(1)100(2)	GMC7.3562(1)100K31(2)
100	63	0.0068	SG/K31	6.0	2.5	7.3	2824	40	F115SG682(1)100(2)	GMC7.3682(1)100K31(2)
100	63	0.0082	SG/K31	6.0	2.5	7.3	2824	40	F115SG822(1)100(2)	GMC7.3822(1)100K31(2)
100	63	0.010	SG/K31	6.0	2.5	7.3	2824	40	F115SG103(1)100(2)	GMC7.3103(1)100K31(2)
100	63	0.012	SG/K31	6.0	2.5	7.3	2824	40	F115SG123(1)100(2)	GMC7.3123(1)100K31(2)
100	63	0.015	SG/K31	6.0	2.5	7.3	2824	40	F115SG153(1)100(2)	GMC7.3153(1)100K31(2)
100	63	0.018	SG/K31	6.0	2.5	7.3	2824	40	F115SG183(1)100(2)	GMC7.3183(1)100K31(2)
100	63	0.022	SG/K31	6.0	2.5	7.3	2824	30	F115SG223(1)100(2)	GMC7.3223(1)100K31(2)
100	63	0.027	SG/K31	6.0	2.5	7.3	2824	30	F115SG273(1)100(2)	GMC7.3273(1)100K31(2)
100	63	0.033	SG/K31	6.0	2.5	7.3	2824	30	F115SG333(1)100(2)	GMC7.3333(1)100K31(2)
100	63	0.039	SG/K31	6.0	2.5	7.3	2824	30	F115SG393(1)100(2)	GMC7.3393(1)100K31(2)
100	63	0.047	SG/K31	6.0	2.5	7.3	2824	30	F115SG473(1)100(2)	GMC7.3473(1)100K31(2)
100	63	0.056	SL/K33	6.0	3.0	7.3	2824	30	F115SL563(1)100(2)	GMC7.3563(1)100K33(2)
100	63	0.068	SP/K35	6.0	3.5	7.3	2824	30	F115SP683(1)100(2)	GMC7.3683(1)100K35(2)
100	63	0.082	SP/K35	6.0	3.5	7.3	2824	30	F115SP823(1)100(2)	GMC7.3823(1)100K35(2)
100	63	0.10	ST/K37	6.0	4.5	7.3	2824	30	F115ST104(1)100(2)	GMC7.3104(1)100K37(2)
100	63	0.022	WPI/A31	9.1	5.5	10.2	4036	40	F115WP223(1)100(2)	GMC10.2223(1)100A31(2)
100	63	0.027	WPI/A31	9.1	5.5	10.2	4036	40	F115WP273(1)100(2)	GMC10.2273(1)100A31(2)
100	63	0.033	WPI/A31	9.1	5.5	10.2	4036	40	F115WP333(1)100(2)	GMC10.2333(1)100A31(2)
100	63	0.039	WPI/A31	9.1	5.5	10.2	4036	40	F115WP393(1)100(2)	GMC10.2393(1)100A31(2)
100	63	0.047	WPI/A31	9.1	5.5	10.2	4036	30	F115WP473(1)100(2)	GMC10.2473(1)100A31(2)
100	63	0.056	WPI/A31	9.1	5.5	10.2	4036	30	F115WP563(1)100(2)	GMC10.2563(1)100A31(2)
100	63	0.068	WPI/A31	9.1	5.5	10.2	4036	30	F115WP683(1)100(2)	GMC10.2683(1)100A31(2)
100	63	0.082	WPI/A31	9.1	5.5	10.2	4036	30	F115WP823(1)100(2)	GMC10.2823(1)100A31(2)
100	63	0.10	WPI/A31	9.1	5.5	10.2	4036	30	F115WP104(1)100(2)	GMC10.2104(1)100A31(2)
100	63	0.12	WPI/A31	9.1	5.5	10.2	4036	30	F115WP124(1)100(2)	GMC10.2124(1)100A31(2)
100	63	0.15	WPI/A31	9.1	5.5	10.2	4036	20	F115WP154(1)100(2)	GMC10.2154(1)100A31(2)
100	63	0.18	WPI/A31	9.1	5.5	10.2	4036	20	F115WP184(1)100(2)	GMC10.2184(1)100A31(2)

(1) J = \pm 5%, K = \pm 10%, other tolerances on request.

(2) Insert ordering code for lead type and packaging. See Ordering Options Table for available options.

Table 1 – Ratings & Part Number Reference cont'd

VDC	VAC	Cap Value (µF)	Size Code (New/Legacy)	Dimensions in mm			Chip Size	dV/dt (V/µs)	New KEMET Part Number	Legacy Part Number
				B	H	L				
100	63	0.22	WPI/A31	9.1	5.5	10.2	4036	20	F115WP224(1)100(2)	GMC10.2224(1)100A31(2)
100	63	0.27	WPI/A31	9.1	5.5	10.2	4036	20	F115WP274(1)100(2)	GMC10.2274(1)100A31(2)
100	63	0.33	WPI/A31	9.1	5.5	10.2	4036	20	F115WP334(1)100(2)	GMC10.2334(1)100A31(2)
100	63	0.39	YR/B31	11.5	6.5	12.7	5045	12	F115YR394(1)100(2)	GMC12.7394(1)100B31(2)
100	63	0.47	YR/B31	11.5	6.5	12.7	5045	12	F115YR474(1)100(2)	GMC12.7474(1)100B31(2)
100	63	0.56	YR/B31	11.5	6.5	12.7	5045	12	F115YR564(1)100(2)	GMC12.7564(1)100B31(2)
100	63	0.68	YR/B31	11.5	6.5	12.7	5045	12	F115YR684(1)100(2)	GMC12.7684(1)100B31(2)
100	63	0.82	ZS/C31	15.0	7.0	16.5	6560	8	F115ZS824(1)100(2)	GMC16.5824(1)100C31(2)
100	63	1.0	ZS/C31	15.0	7.0	16.5	6560	8	F115ZS105(1)100(2)	GMC16.5105(1)100C31(2)
100	63	1.2	ZS/C31	15.0	7.0	16.5	6560	8	F115ZS125(1)100(2)	GMC16.5125(1)100C31(2)
100	63	1.5	ZS/C31	15.0	7.0	16.5	6560	8	F115ZS155(1)100(2)	GMC16.5155(1)100C31(2)
100	63	1.8	ZS/C31	15.0	7.0	16.5	6560	8	F115ZS185(1)100(2)	GMC16.5185(1)100C31(2)
100	63	2.2	ZS/C31	15.0	7.0	16.5	6560	8	F115ZS225(1)100(2)	GMC16.5225(1)100C31(2)
250	160	0.0010	PL/J31	5.0	2.5	5.7	2220	40	F115PL102(1)250(2)	GMC5.7102(1)250J31(2)
250	160	0.0012	PL/J31	5.0	2.5	5.7	2220	40	F115PL122(1)250(2)	GMC5.7122(1)250J31(2)
250	160	0.0015	PL/J31	5.0	2.5	5.7	2220	40	F115PL152(1)250(2)	GMC5.7152(1)250J31(2)
250	160	0.0018	PL/J31	5.0	2.5	5.7	2220	40	F115PL182(1)250(2)	GMC5.7182(1)250J31(2)
250	160	0.0022	PL/J31	5.0	2.5	5.7	2220	40	F115PL222(1)250(2)	GMC5.7222(1)250J31(2)
250	160	0.0027	PL/J31	5.0	2.5	5.7	2220	40	F115PL272(1)250(2)	GMC5.7272(1)250J31(2)
250	160	0.0033	PL/J31	5.0	2.5	5.7	2220	40	F115PL332(1)250(2)	GMC5.7332(1)250J31(2)
250	160	0.0039	PL/J31	5.0	2.5	5.7	2220	40	F115PL392(1)250(2)	GMC5.7392(1)250J31(2)
250	160	0.0047	PL/J31	5.0	2.5	5.7	2220	40	F115PL472(1)250(2)	GMC5.7472(1)250J31(2)
250	160	0.0056	PL/J31	5.0	2.5	5.7	2220	40	F115PL562(1)250(2)	GMC5.7562(1)250J31(2)
250	160	0.0068	PL/J31	5.0	2.5	5.7	2220	40	F115PL682(1)250(2)	GMC5.7682(1)250J31(2)
250	160	0.0082	PL/J31	5.0	2.5	5.7	2220	40	F115PL822(1)250(2)	GMC5.7822(1)250J31(2)
250	160	0.010	PL/J31	5.0	2.5	5.7	2220	40	F115PL103(1)250(2)	GMC5.7103(1)250J31(2)
250	160	0.012	PP/J33	5.0	3.0	5.7	2220	40	F115PP123(1)250(2)	GMC5.7123(1)250J33(2)
250	160	0.015	PP/J33	5.0	3.0	5.7	2220	40	F115PP153(1)250(2)	GMC5.7153(1)250J33(2)
250	160	0.018	PP/J33	5.0	3.0	5.7	2220	40	F115PP183(1)250(2)	GMC5.7183(1)250J33(2)
250	160	0.022	PU/J35	5.0	4.0	5.7	2220	40	F115PU223(1)250(2)	GMC5.7223(1)250J35(2)
250	160	0.0010	SG/K31	6.0	2.5	7.3	2824	50	F115SG102(1)250(2)	GMC7.3102(1)250K31(2)
250	160	0.0012	SG/K31	6.0	2.5	7.3	2824	50	F115SG122(1)250(2)	GMC7.3122(1)250K31(2)
250	160	0.0015	SG/K31	6.0	2.5	7.3	2824	50	F115SG152(1)250(2)	GMC7.3152(1)250K31(2)
250	160	0.0018	SG/K31	6.0	2.5	7.3	2824	50	F115SG182(1)250(2)	GMC7.3182(1)250K31(2)
250	160	0.0022	SG/K31	6.0	2.5	7.3	2824	50	F115SG222(1)250(2)	GMC7.3222(1)250K31(2)
250	160	0.0027	SG/K31	6.0	2.5	7.3	2824	50	F115SG272(1)250(2)	GMC7.3272(1)250K31(2)
250	160	0.0033	SG/K31	6.0	2.5	7.3	2824	50	F115SG332(1)250(2)	GMC7.3332(1)250K31(2)
250	160	0.0039	SG/K31	6.0	2.5	7.3	2824	50	F115SG392(1)250(2)	GMC7.3392(1)250K31(2)
250	160	0.0047	SG/K31	6.0	2.5	7.3	2824	50	F115SG472(1)250(2)	GMC7.3472(1)250K31(2)
250	160	0.0056	SG/K31	6.0	2.5	7.3	2824	50	F115SG562(1)250(2)	GMC7.3562(1)250K31(2)
250	160	0.0068	SG/K31	6.0	2.5	7.3	2824	40	F115SG682(1)250(2)	GMC7.3682(1)250K31(2)
250	160	0.0082	SG/K31	6.0	2.5	7.3	2824	40	F115SG822(1)250(2)	GMC7.3822(1)250K31(2)
250	160	0.010	SG/K31	6.0	2.5	7.3	2824	40	F115SG103(1)250(2)	GMC7.3103(1)250K31(2)
250	160	0.012	SG/K31	6.0	2.5	7.3	2824	40	F115SG123(1)250(2)	GMC7.3123(1)250K31(2)
250	160	0.015	SG/K31	6.0	2.5	7.3	2824	40	F115SG153(1)250(2)	GMC7.3153(1)250K31(2)
250	160	0.018	SL/K33	6.0	3.0	7.3	2824	40	F115SL183(1)250(2)	GMC7.3183(1)250K33(2)
250	160	0.022	SL/K33	6.0	3.0	7.3	2824	40	F115SL223(1)250(2)	GMC7.3223(1)250K33(2)
250	160	0.027	SPI/K35	6.0	3.5	7.3	2824	40	F115SP273(1)250(2)	GMC7.3273(1)250K35(2)
250	160	0.033	ST/K37	6.0	4.5	7.3	2824	30	F115ST333(1)250(2)	GMC7.3333(1)250K37(2)
250	160	0.039	ST/K37	6.0	4.5	7.3	2824	30	F115ST393(1)250(2)	GMC7.3393(1)250K37(2)
250	160	0.022	WPI/A31	9.1	5.5	10.2	4036	40	F115WP223(1)250(2)	GMC10.2223(1)250A31(2)
250	160	0.027	WPI/A31	9.1	5.5	10.2	4036	40	F115WP273(1)250(2)	GMC10.2273(1)250A31(2)
250	160	0.033	WPI/A31	9.1	5.5	10.2	4036	40	F115WP333(1)250(2)	GMC10.2333(1)250A31(2)
250	160	0.039	WPI/A31	9.1	5.5	10.2	4036	40	F115WP393(1)250(2)	GMC10.2393(1)250A31(2)
250	160	0.047	WPI/A31	9.1	5.5	10.2	4036	30	F115WP473(1)250(2)	GMC10.2473(1)250A31(2)
250	160	0.056	WPI/A31	9.1	5.5	10.2	4036	30	F115WP563(1)250(2)	GMC10.2563(1)250A31(2)
250	160	0.068	WPI/A31	9.1	5.5	10.2	4036	30	F115WP683(1)250(2)	GMC10.2683(1)250A31(2)
250	160	0.082	WPI/A31	9.1	5.5	10.2	4036	30	F115WP823(1)250(2)	GMC10.2823(1)250A31(2)
250	160	0.10	WPI/A31	9.1	5.5	10.2	4036	30	F115WP104(1)250(2)	GMC10.2104(1)250A31(2)

(1) J = ±5%, K = ±10%, other tolerances on request.

(2) Insert ordering code for lead type and packaging. See Ordering Options Table for available options.

Table 1 – Ratings & Part Number Reference cont'd

VDC	VAC	Cap Value (μ F)	Size Code (New/Legacy)	Dimensions in mm			Chip Size	dV/dt (V/ μ s)	New KEMET Part Number	Legacy Part Number
				B	H	L				
250	160	0.12	WP/A31	9.1	5.5	10.2	4036	30	F115WP124(1)250(2)	GMC10.2124(1)250A31(2)
250	160	0.15	WP/A31	9.1	5.5	10.2	4036	30	F115WP154(1)250(2)	GMC10.2154(1)250A31(2)
250	160	0.18	YR/B31	11.5	6.5	12.7	5045	20	F115YR184(1)250(2)	GMC12.7184(1)250B31(2)
250	160	0.22	YR/B31	11.5	6.5	12.7	5045	20	F115YR224(1)250(2)	GMC12.7224(1)250B31(2)
250	160	0.27	YR/B31	11.5	6.5	12.7	5045	20	F115YR274(1)250(2)	GMC12.7274(1)250B31(2)
250	160	0.33	YR/B31	11.5	6.5	12.7	5045	20	F115YR334(1)250(2)	GMC12.7334(1)250B31(2)
250	160	0.39	ZS/C31	15.0	7.0	16.5	6560	12	F115ZS394(1)250(2)	GMC16.5394(1)250C31(2)
250	160	0.47	ZS/C31	15.0	7.0	16.5	6560	12	F115ZS474(1)250(2)	GMC16.5474(1)250C31(2)
250	160	0.56	ZS/C31	15.0	7.0	16.5	6560	12	F115ZS564(1)250(2)	GMC16.5564(1)250C31(2)
250	160	0.68	ZS/C31	15.0	7.0	16.5	6560	12	F115ZS684(1)250(2)	GMC16.5684(1)250C31(2)
400	200	0.0010	SG/K31	6.0	2.5	7.3	2824	50	F115SG102(1)400(2)	GMC7.3102(1)400K31(2)
400	200	0.0012	SG/K31	6.0	2.5	7.3	2824	50	F115SG122(1)400(2)	GMC7.3122(1)400K31(2)
400	200	0.0015	SG/K31	6.0	2.5	7.3	2824	50	F115SG152(1)400(2)	GMC7.3152(1)400K31(2)
400	200	0.0018	SG/K31	6.0	2.5	7.3	2824	50	F115SG182(1)400(2)	GMC7.3182(1)400K31(2)
400	200	0.0022	SG/K31	6.0	2.5	7.3	2824	50	F115SG222(1)400(2)	GMC7.3222(1)400K31(2)
400	200	0.0027	SG/K31	6.0	2.5	7.3	2824	50	F115SG272(1)400(2)	GMC7.3272(1)400K31(2)
400	200	0.0033	SG/K31	6.0	2.5	7.3	2824	50	F115SG332(1)400(2)	GMC7.3332(1)400K31(2)
400	200	0.0039	SG/K31	6.0	2.5	7.3	2824	50	F115SG392(1)400(2)	GMC7.3392(1)400K31(2)
400	200	0.0047	SG/K31	6.0	2.5	7.3	2824	50	F115SG472(1)400(2)	GMC7.3472(1)400K31(2)
400	200	0.0056	SG/K31	6.0	2.5	7.3	2824	50	F115SG562(1)400(2)	GMC7.3562(1)400K31(2)
400	200	0.0068	SL/K33	6.0	3.0	7.3	2824	50	F115SL682(1)400(2)	GMC7.3682(1)400K33(2)
400	200	0.0082	SP/K35	6.0	3.5	7.3	2824	50	F115SP822(1)400(2)	GMC7.3822(1)400K35(2)
400	200	0.010	SP/K35	6.0	3.5	7.3	2824	50	F115SP103(1)400(2)	GMC7.3103(1)400K35(2)
400	200	0.012	SP/K35	6.0	3.5	7.3	2824	50	F115SP123(1)400(2)	GMC7.3123(1)400K35(2)
400	200	0.015	ST/K37	6.0	4.5	7.3	2824	50	F115ST153(1)400(2)	GMC7.3153(1)400K37(2)
400	200	0.022	WP/A31	9.1	5.5	10.2	4036	40	F115WP223(1)400(2)	GMC10.2223(1)400A31(2)
400	200	0.027	WP/A31	9.1	5.5	10.2	4036	40	F115WP273(1)400(2)	GMC10.2273(1)400A31(2)
400	200	0.033	WP/A31	9.1	5.5	10.2	4036	40	F115WP333(1)400(2)	GMC10.2333(1)400A31(2)
400	200	0.039	WP/A31	9.1	5.5	10.2	4036	40	F115WP393(1)400(2)	GMC10.2393(1)400A31(2)
400	200	0.047	WP/A31	9.1	5.5	10.2	4036	40	F115WP473(1)400(2)	GMC10.2473(1)400A31(2)
400	200	0.056	YR/B31	11.5	6.5	12.7	5045	30	F115YR563(1)400(2)	GMC12.7563(1)400B31(2)
400	200	0.068	YR/B31	11.5	6.5	12.7	5045	30	F115YR683(1)400(2)	GMC12.7683(1)400B31(2)
400	200	0.082	YR/B31	11.5	6.5	12.7	5045	30	F115YR823(1)400(2)	GMC12.7823(1)400B31(2)
400	200	0.10	YR/B31	11.5	6.5	12.7	5045	30	F115YR104(1)400(2)	GMC12.7104(1)400B31(2)
400	200	0.12	ZS/C31	15.0	7.0	16.5	6560	20	F115ZS124(1)400(2)	GMC16.5124(1)400C31(2)
400	200	0.15	ZS/C31	15.0	7.0	16.5	6560	20	F115ZS154(1)400(2)	GMC16.5154(1)400C31(2)
400	200	0.18	ZS/C31	15.0	7.0	16.5	6560	20	F115ZS184(1)400(2)	GMC16.5184(1)400C31(2)
400	200	0.22	ZS/C31	15.0	7.0	16.5	6560	20	F115ZS224(1)400(2)	GMC16.5224(1)400C31(2)
400	200	0.27	ZS/C31	15.0	7.0	16.5	6560	20	F115ZS274(1)400(2)	GMC16.5274(1)400C31(2)
400	200	0.33	ZS/C31	15.0	7.0	16.5	6560	20	F115ZS334(1)400(2)	GMC16.5334(1)400C31(2)
630	300	0.022	WP/A31	9.1	5.5	10.2	4036	40	F115WP223(1)630(2)	GMC10.2223(1)630A31(2)
630	300	0.027	YR/B31	11.5	6.5	12.7	5045	30	F115YR273(1)630(2)	GMC12.7273(1)630B31(2)
630	300	0.033	YR/B31	11.5	6.5	12.7	5045	30	F115YR333(1)630(2)	GMC12.7333(1)630B31(2)
630	300	0.039	YR/B31	11.5	6.5	12.7	5045	30	F115YR393(1)630(2)	GMC12.7393(1)630B31(2)
630	300	0.047	YR/B31	11.5	6.5	12.7	5045	30	F115YR473(1)630(2)	GMC12.7473(1)630B31(2)
630	300	0.056	YR/B31	11.5	6.5	12.7	5045	30	F115YR563(1)630(2)	GMC12.7563(1)630B31(2)
630	300	0.068	ZS/C31	15.0	7.0	16.5	6560	20	F115ZS683(1)630(2)	GMC16.5683(1)630C31(2)
630	300	0.082	ZS/C31	15.0	7.0	16.5	6560	20	F115ZS823(1)630(2)	GMC16.5823(1)630C31(2)
630	300	0.10	ZS/C31	15.0	7.0	16.5	6560	20	F115ZS104(1)630(2)	GMC16.5104(1)630C31(2)
630	300	0.12	ZS/C31	15.0	7.0	16.5	6560	20	F115ZS124(1)630(2)	GMC16.5124(1)630C31(2)
630	300	0.15	ZS/C31	15.0	7.0	16.5	6560	20	F115ZS154(1)630(2)	GMC16.5154(1)630C31(2)
VDC	VAC	Capacitance Value (μ F)	Size Code (New/Legacy)	B (mm)	H (mm)	L (mm)	Chip Size	dV/dt (V/ μ s)	New KEMET Part Number	Legacy Part Number

(1) J = \pm 5%, K = \pm 10%, other tolerances on request.

(2) Insert ordering code for lead type and packaging. See Ordering Options Table for available options.

Soldering Process

Reflow soldering temperature is measured on the top body surface of the component. Preheating temperature should be less than 170°C. The time above 217°C should be less than 50 seconds. The peak temperature must not exceed 250°C.

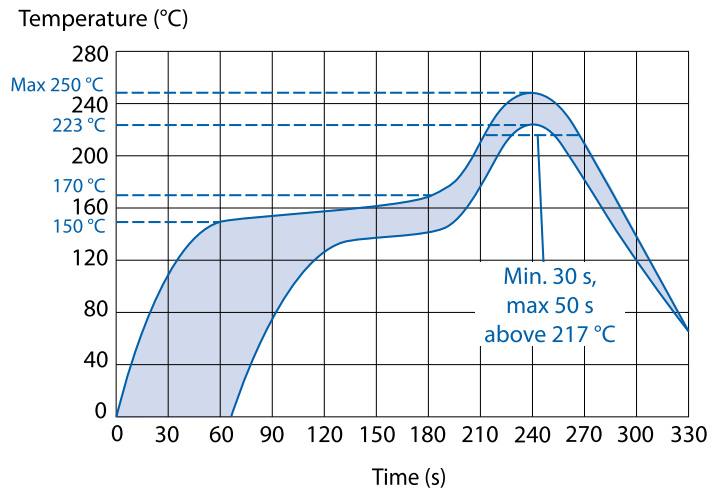

Marking

- Capacitance
- Capacitance tolerance code
- Rated voltage code
- Capacitor type G for GMC
- Manufacturing date code

Packaging Quantities

Chip Size (EIA)	Base (mm)	Height (mm)	Length (mm)	Bulk	Reel Horizontal Orientation	Reel Vertical Orientation
2220	5	2.5	5.7	2000	3100	
2220	5	3	5.7	2000	2400	
2220	5	4	5.7	2000	2100	
2824	6	2.5	7.3	2000	3100	
2824	6	3	7.3	2000	2500	
2824	6	3.5	7.3	2000	2300	
2824	6	4.5	7.3	1000	1700	
4036	9.1	5.5	10.2	1000	800	500
5045	11.5	6.5	12.7	1000	600	400
6560	15	7	16.5	800	500	200

Carrier Taping & Packaging (IEC 60286–2)

Horizontal Taping Orientation

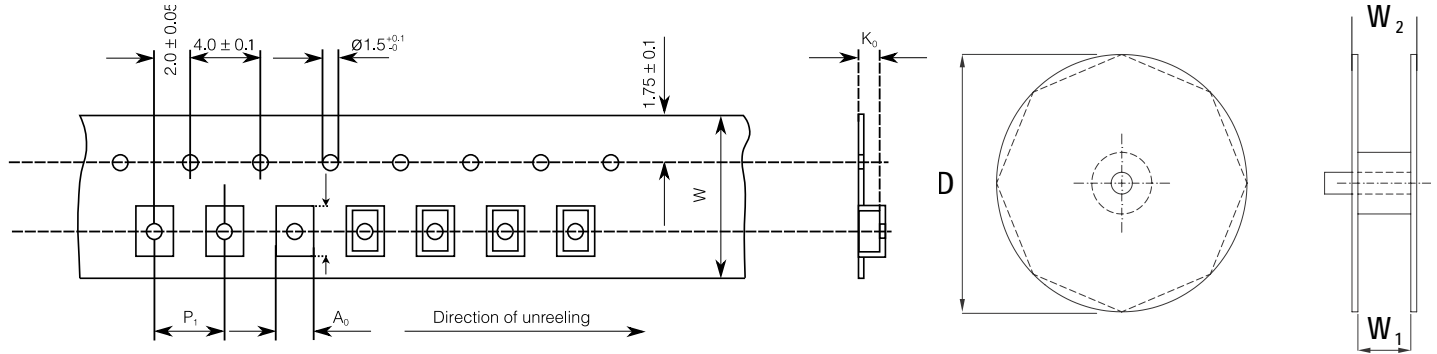

EIA Size Code Horizontal Mounting	Dimensions in mm			Taping Specification							
	B	H	L	W	P ₁	A ₀	B ₀	K ₀	D	W ₁	W ₂
	Nominal	Nominal	Nominal	-0/+0.3	+/-0.1	Nominal	Nominal	Nominal	-/+2.0	-0/+2	Maximum
2220	5.0	2.5	5.7	12.0	8.0	5.5	6.0	2.8	330	12.4	22.0
2220	5.0	3.0	5.7	12.0	8.0	5.5	6.0	3.3	330	12.4	22.0
2220	5.0	4.0	5.7	12.0	8.0	5.5	6.0	4.3	330	12.4	22.0
2824	6.0	2.5	7.3	12.0	8.0	6.5	7.5	2.8	330	12.4	22.0
2824	6.0	3.0	7.3	12.0	8.0	6.5	7.5	3.3	330	12.4	22.0
2824	6.0	3.5	7.3	12.0	8.0	6.5	7.5	3.8	330	12.4	22.0
2824	6.0	4.5	7.3	12.0	8.0	6.5	7.5	4.8	330	12.4	22.0
4036	9.1	5.5	10.2	16.0	16.0	9.5	10.5	5.8	330	16.4	22.0
5045	11.5	6.5	12.7	24.0	16.0	11.9	13.1	6.8	330	24.4	30.0
6560	15.0	7.0	16.5	24.0	20.0	15.4	16.8	7.3	330	24.4	30.0

Carrier Taping & Packaging (IEC 60286-2) cont'd

Vertical Taping Orientation

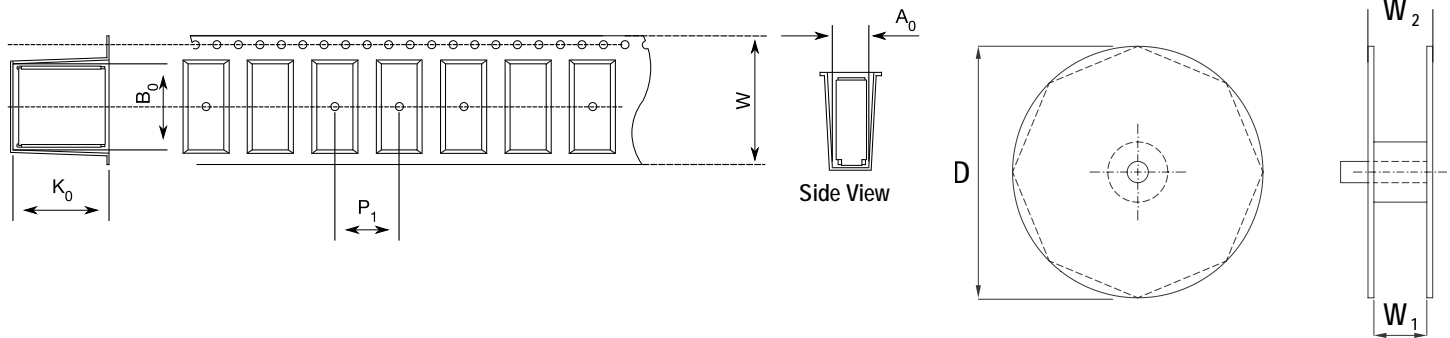

Size Code Vertical Mounting	Dimensions in mm			Taping Specification							
	B	H	L	W	P_1	A_0	B_0	K_0	D	W_1	W_2
	Nominal	Nominal	Nominal	-0/+0.3	+/-0.1	Nominal	Nominal	Nominal	-/+2.0	-0/+2	Maximum
4022	5.5	9.1	10.2	24.0	16.0	6.0	10.5	9.3	330	24.4	30.0
5026	6.5	11.5	12.7	24.0	16.0	6.9	13.1	11.8	330	24.4	30.0
6528	7.0	15.0	16.5	44.0	20.0	7.5	17.0	15.3	330	44.5	49.5

Note: Chip dimensions B and H correspond to dimensions H and B in the horizontal mounting table.

KEMET Corporation World Headquarters

2835 KEMET Way
Simpsonville, SC 29681

Mailing Address:
P.O. Box 5928
Greenville, SC 29606

www.kemet.com
Tel: 864-963-6300
Fax: 864-963-6521

Corporate Offices
Fort Lauderdale, FL
Tel: 954-766-2800

North America

Southeast
Lake Mary, FL
Tel: 407-855-8886

Northeast
Wilmington, MA
Tel: 978-658-1663

Central
Novi, MI
Tel: 248-994-1030

West
Milpitas, CA
Tel: 408-433-9950

Mexico
Guadalajara, Jalisco
Tel: 52-33-3123-2141

Europe

Southern Europe
Paris, France
Tel: 33-1-4646-1006

Sasso Marconi, Italy
Tel: 39-051-939111

Central Europe
Landsberg, Germany
Tel: 49-8191-3350800

Kamen, Germany
Tel: 49-2307-438110

Northern Europe
Bishop's Stortford, United Kingdom
Tel: 44-1279-460122

Espoo, Finland
Tel: 358-9-5406-5000

Asia

Northeast Asia
Hong Kong
Tel: 852-2305-1168

Shenzhen, China
Tel: 86-755-2518-1306

Beijing, China
Tel: 86-10-5829-1711

Shanghai, China
Tel: 86-21-6447-0707

Taipei, Taiwan
Tel: 886-2-27528585

Southeast Asia
Singapore
Tel: 65-6586-1900

Penang, Malaysia
Tel: 60-4-6430200

Bangalore, India
Tel: 91-806-53-76817

Note: KEMET reserves the right to modify minor details of internal and external construction at any time in the interest of product improvement. KEMET does not assume any responsibility for infringement that might result from the use of KEMET Capacitors in potential circuit designs. KEMET is a registered trademark of KEMET Electronics Corporation.

Other KEMET Resources

Tools	
Resource	Location
Configure A Part: CapEdge	http://capacitoredge.kemet.com
SPICE & FIT Software	http://www.kemet.com/spice
Search Our FAQs: KnowledgeEdge	http://www.kemet.com/keask
Electrolytic LifeCalculator	http://www.kemet.com:8080/elc

Product Information	
Resource	Location
Products	http://www.kemet.com/products
Technical Resources (Including Soldering Techniques)	http://www.kemet.com/technicalpapers
RoHS Statement	http://www.kemet.com/rohs
Quality Documents	http://www.kemet.com/qualitydocuments

Product Request	
Resource	Location
Sample Request	http://www.kemet.com/sample
Engineering Kit Request	http://www.kemet.com/kits

Contact	
Resource	Location
Website	www.kemet.com
Contact Us	http://www.kemet.com/contact
Investor Relations	http://www.kemet.com/ir
Call Us	1-877-MyKEMET
Twitter	http://twitter.com/kemetcapacitors

Disclaimer

All product specifications, statements, information and data (collectively, the "Information") in this datasheet are subject to change. The customer is responsible for checking and verifying the extent to which the Information contained in this publication is applicable to an order at the time the order is placed.

All Information given herein is believed to be accurate and reliable, but it is presented without guarantee, warranty, or responsibility of any kind, expressed or implied.

Statements of suitability for certain applications are based on KEMET Electronics Corporation's ("KEMET") knowledge of typical operating conditions for such applications, but are not intended to constitute – and KEMET specifically disclaims – any warranty concerning suitability for a specific customer application or use. The Information is intended for use only by customers who have the requisite experience and capability to determine the correct products for their application. Any technical advice inferred from this Information or otherwise provided by KEMET with reference to the use of KEMET's products is given gratis, and KEMET assumes no obligation or liability for the advice given or results obtained.

Although KEMET designs and manufactures its products to the most stringent quality and safety standards, given the current state of the art, isolated component failures may still occur. Accordingly, customer applications which require a high degree of reliability or safety should employ suitable designs or other safeguards (such as installation of protective circuitry or redundancies) in order to ensure that the failure of an electrical component does not result in a risk of personal injury or property damage.

Although all product-related warnings, cautions and notes must be observed, the customer should not assume that all safety measures are indicated or that other measures may not be required.

