

# Distinctive Characteristics

Carefully designed light diffusion and filtering system produces bright, full surface illumination with front panel relamping.

Spot illumination available in single and bicolor LEDs.

Choice of super bright LEDs in white, green, and blue in addition to standard or bright red, amber, and green LEDs.

Stainless steel clips provide secure mounting with a wide range of panel thicknesses.

Latchdown feature gives indication of circuit status. Audible and tactile feedback with smooth and responsive operation.

Snap-action contact mechanism gives long electrical life and sensitivity of actuation.

Combination solder lug and .110" quick connect terminals are epoxy sealed to prevent entry of flux, dust, and other contaminants.

Panel sealed model meets IP65 of IEC60529 specifications (similar to NEMA 4 & 13).

Compact switch design minimizes behind panel depth.

Matching indicators available.

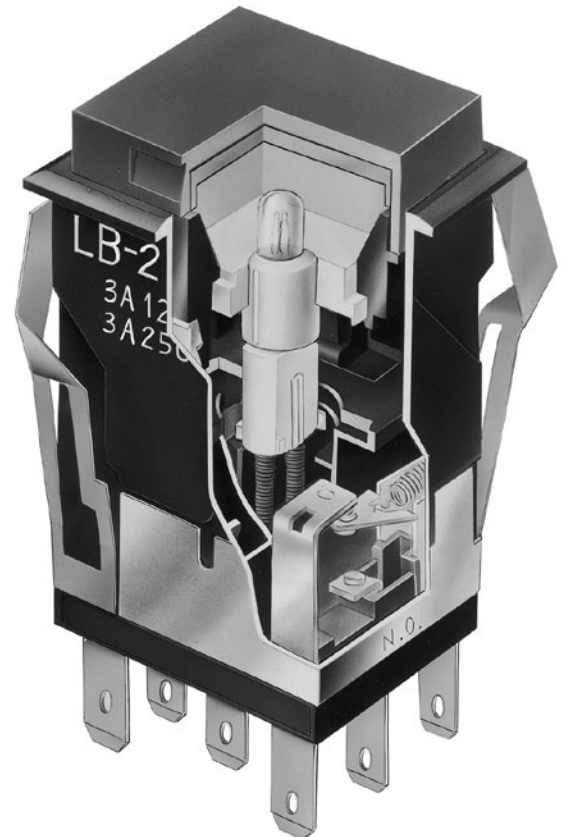

Actual Size

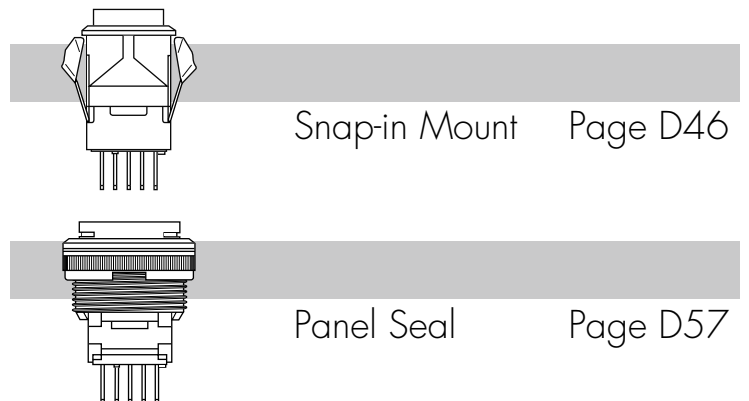
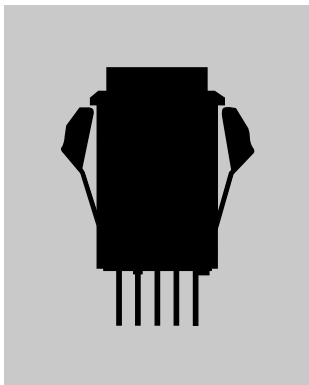

- Toggle
- Rockers
- Pushbuttons
- D Illuminated PB**
- Programmable
- Keylocks
- Rotaries
- Slides
- Tactiles
- Tilt
- Touch
- Indicators
- Accessories
- Supplement

# General Specifications

## Electrical Capacity (Resistive Load)

<b>Power Level (silver):</b>	3A @ 125V AC or 3A @ 250V AC or 3A @ 30V DC
<b>Logic Level (gold):</b>	0.4VA maximum @ 28V AC/DC maximum (Applicable Range 0.1mA ~ 0.1A @ 20mV ~ 28V)

Note: Find additional explanation of operating range in Supplement section.

## Other Ratings

<b>Contact Resistance:</b>	50 milliohms maximum for silver; 100 milliohms maximum for gold
<b>Insulation Resistance:</b>	200 megohms minimum @ 500V DC
<b>Dielectric Strength:</b>	1,000V AC minimum between contacts for 1 minute minimum; 1,500V AC minimum between contacts & case for 1 minute minimum
<b>Mechanical Life:</b>	1,000,000 operations minimum for momentary circuit 200,000 operations minimum for maintained circuit
<b>Electrical Life:</b>	100,000 operations minimum
<b>Nominal Operating Force:</b>	5.39N
<b>Contact Timing:</b>	Nonshorting (break-before-make)
<b>Travel:</b>	Pretravel .059" (1.5mm); Overtravel .059" (1.5mm); Total Travel .118" (3.0mm)

## Materials & Finishes

<b>Housing:</b>	Glass fiber reinforced polyamide (UL94V-0)
<b>O-ring:</b>	Nitrile butadiene rubber
<b>Inner Seal:</b>	Silicone rubber
<b>Movable Contact:</b>	Silver alloy or copper with gold plating
<b>Stationary Contacts:</b>	Silver alloy or copper with gold plating
<b>Base:</b>	Liquid crystal polymer (UL94V-0)
<b>Switch Terminals:</b>	Phosphor bronze with silver or gold plating
<b>Lamp Terminals:</b>	Brass with silver plating

## Environmental Data

<b>Operating Temperature Range:</b>	-25°C through +50°C (-13°F through +122°F) for Illuminated -25°C through +70°C (-13°F through +158°F) for Nonilluminated Note: When used with a polyvinyl chloride splash cover, the lowest limit is 0°C (32°F)
<b>Humidity:</b>	90 ~ 95% humidity for 96 hours @ 40°C (104°F)
<b>Vibration:</b>	10 ~ 55Hz with peak-to-peak amplitude of 1.5mm traversing the frequency range & returning in 1 minute; 3 right angled directions for 2 hours
<b>Shock:</b>	50G (490m/s <sup>2</sup> ) acceleration (tested in 6 right angled directions, with 5 shocks in each direction)
<b>Sealing:</b>	IP65 of IEC60529 standard (similar to NEMA 4 & 13)

## Installation

<b>Mounting Torque:</b>	1.96Nm (17.35 lb•in) maximum
<b>Cap Installation Force:</b>	3.92N maximum downward force on cap
<b>Quick Connect Force:</b>	52.95N maximum downward force on connector
<b>Soldering Time &amp; Temperature:</b>	Manual Soldering: See Profile A in Supplement section.

## Standards & Certifications

<b>Flammability Standards:</b>	UL94V-0 housing & base
<b>UL:</b>	<b>File No. E44145 - Recognized only when ordered with marking on switch.</b> Add "/U" or "/CUL" before first dash in part number to order UL recognized switch. All models recognized at 3A @ 125V or 250V AC or 0.4VA @ 28V AC/DC maximum.
<b>CSA:</b>	<b>File No. 023535_0_000 - Certified only when ordered with marking on switch.</b> Add "/C" before first dash in part number to order CSA certified switch. All models certified at 3A @ 125V or 250V AC or 0.4VA @ 28V AC/DC maximum.

## TYPICAL SWITCH ORDERING EXAMPLE

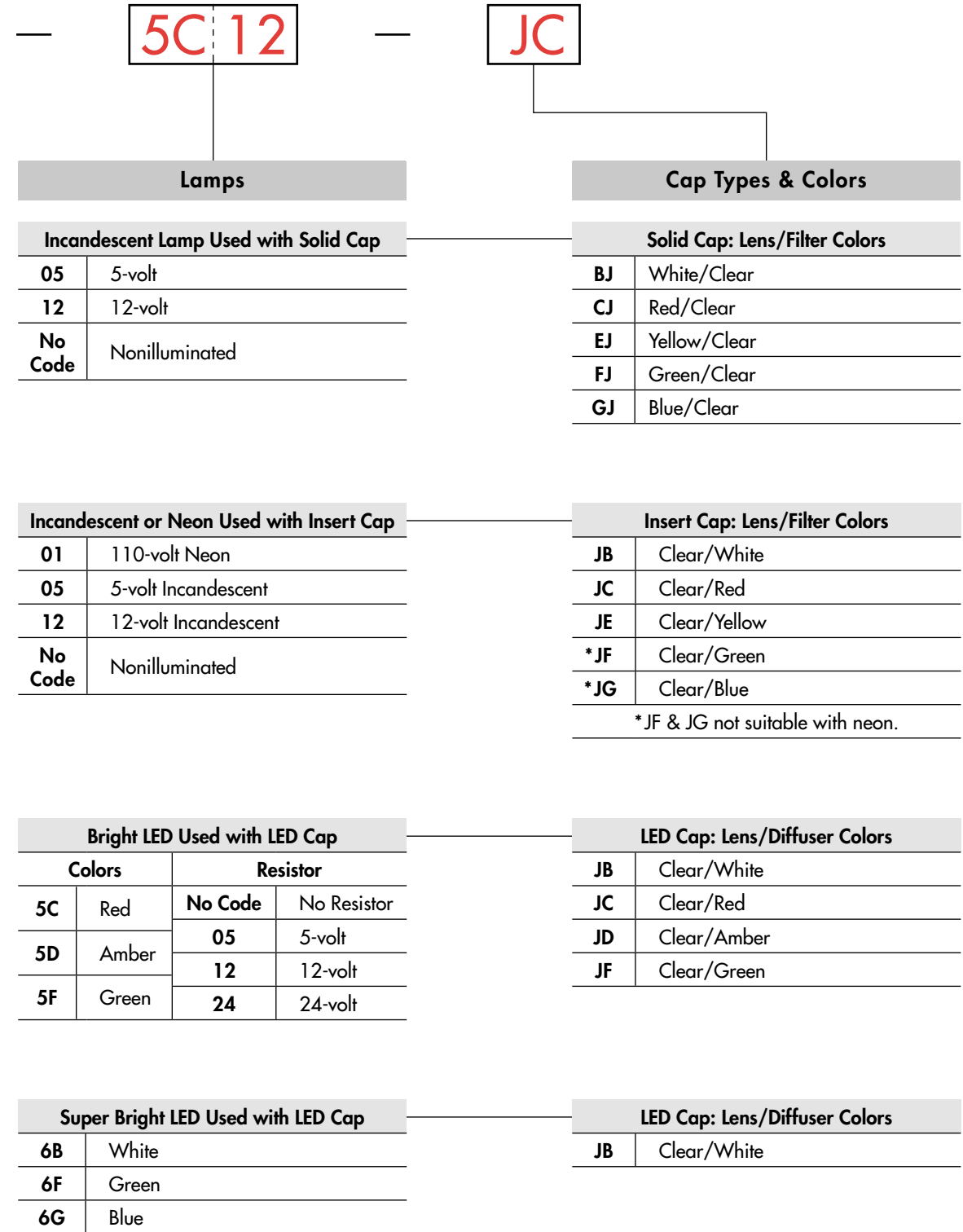
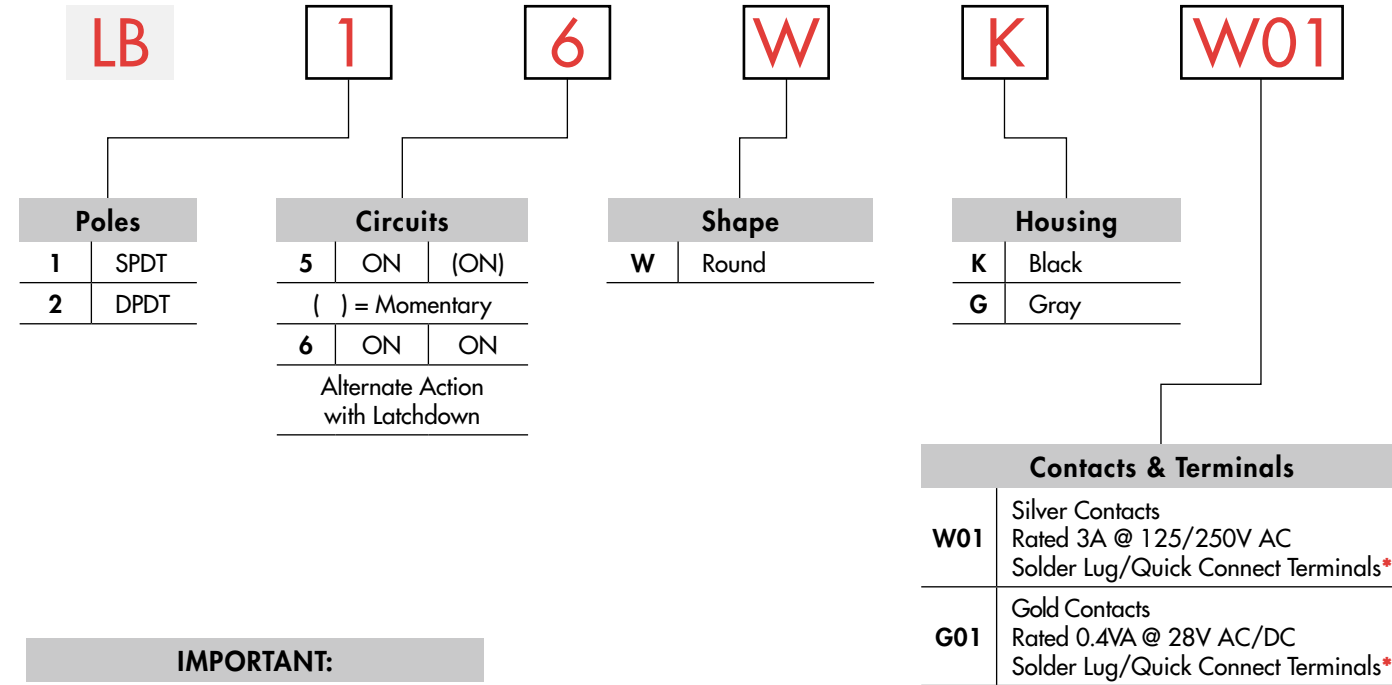

**IMPORTANT:**

Switches are supplied without UL, cULus & CSA marking unless specified. **UL, cULus & CSA recognized only when ordered with marking on the switch.** Specific models, ratings, & ordering instructions are noted on General Specifications page.

\* Wire harness & cable assemblies offered only in Americas

### DESCRIPTION FOR TYPICAL ORDERING EXAMPLE

**LB16WKW01-5C12-JC**



Toggles

Rockers

Pushbuttons

Illuminated PB

Programmable

Keylocks

Rotaries

Slides

Tactiles

Tilt

Touch

Indicators

Accessories

Supplement

## POLES & CIRCUITS

Pole	Model	Plunger Position ( ) = Momentary		Connected Terminals		Throw & Switch/Lamp Schematics
		Normal	Down	Normal	Down	
SP	LB15 *LB16	ON ON	(ON) ON	1-3	1-2	Notes: Switch is marked with NC, NO, COM, L+, L-. Lamp circuit is isolated and requires external power source.  
DP	LB25 *LB26	ON ON	(ON) ON	1-3 4-6	1-2 4-5	

\* When in latchdown position for the alternate circuit, cap position is .039" (1.0mm) above the built-in bezel.

## SHAPE & PANEL CUTOUT

**W** .866" (22.0mm)  
Round

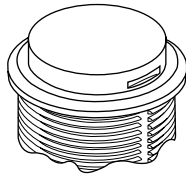

Recommended Panel Thickness:  
.039" ~ .157" (1.0mm ~ 4.0mm)

Recommended Panel Thickness with Splash Cover:  
.039" ~ .138" (1.0mm ~ 3.5mm)

Overtightening the mounting nut AT074  
may damage the switch housing.

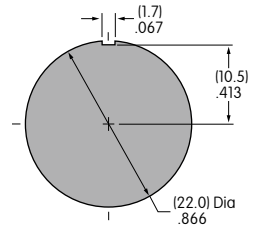

## HOUSING

Housing Colors Available:

**K** Black

**G** Gray

## CONTACT MATERIALS, RATINGS & TERMINALS

**W01** Silver Contacts

Power Level  
3A @ 125V AC & 250V AC

Solder Lug/Quick Connect

**G01** Gold Contacts

Logic Level  
0.4VA max. @ 28V AC/DC max.

Optional PCB adaptors AT711  
& AT712 available; illustrated  
in previous snap-in subsection.

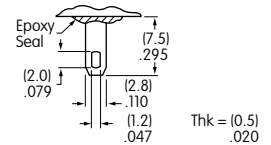

Complete explanation of operating range in Supplement section.

## INCANDESCENT & NEON LAMP CODES & SPECIFICATIONS

AT607 & AT607N

AT607 Incandescent 5-volt or  
12-volt; AT607N Neon 110-volt

**05**

**12**

**01** \*

Voltage V 5V AC 12V AC 110V AC

Current I 115mA 60mA 1.5mA

Endurance Avg. Hours 10,000 10,000

Ambient Temp. Range -25°C ~ +50°C

The electrical specifications shown are  
determined at a basic temperature of  
25°C. Lamp circuit is isolated and  
requires external power source.

\* Recommended Resistors for Neon:  
33K ohms for 110V AC;  
100K ohms for 220V AC



T-1 Bi-pin

## LED COLORS & SPECIFICATIONS

The electrical specifications shown are determined at a basic temperature of 25°C.  
 LED circuit is isolated and requires external power source. Polarity marks are on the switch.  
 If the source voltage exceeds the rated voltage, a ballast resistor is required.  
 The resistor value can be calculated by using the formula in the Supplement section.  
 Additional lamp detail is shown in the Accessories & Hardware section.

### Bright LED without Resistor

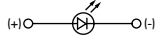
<b>AT635</b>  LEDs are colored in OFF state.      T-1½ Bi-pin	Color Codes	Red <b>5C</b>	Amber <b>5D</b>	Green <b>5F</b>	<b>No Code</b> No Resistor		
	Forward Peak Current	$I_{FM}$			Red	Amber	Green
	Typical Forward Current	$I_F$			30mA	30mA	30mA
	Forward Voltage	$V_F$			1.9V	2.0V	2.1V
	Reverse Peak Voltage	$V_{RM}$			5V	5V	5V
	Current Reduction Rate Above 25°C	$\Delta I_F$			0.42mA/°C		
	Ambient Temperature Range				-25° ~ +50°C		

### Bright LED with Resistor

<b>AT627 with Resistor</b>    T-1 Bi-pin	Color Codes:	Red <b>5C</b>	Amber <b>5D</b>	Green <b>5F</b>	Resistor Codes		
	Forward Peak Current	$I_{FM}$			<b>05</b>	<b>12</b>	<b>24</b>
	Typical Forward Current	$I_F$			—	—	—
	Forward Voltage	$V_F$			5V	12V	24V
	Reverse Peak Voltage	$V_{RM}$			4V	8V	16V
	Current Reduction Rate Above 25°C	$\Delta I_F$			0.50mA/°C		
	Ambient Temperature Range				-25° ~ +50°C		

AT627  
5-volt  
4-element  
with Resistor

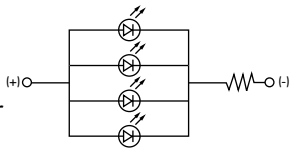

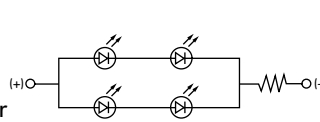

AT627  
12-volt  
4-element  
with Resistor

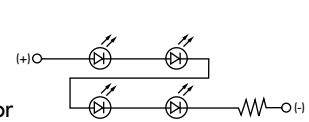

AT627  
24-volt  
4-element  
with Resistor

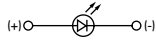

### Super Bright Single Element LED

<b>AT625G Blue</b> <b>AT631B White</b> <b>AT632F Green</b>      T-1 Bi-pin				<b>6B</b>	<b>6F</b>	<b>6G</b>	
	Color			White	Green	Blue	
	Forward Peak Current	$I_{FM}$			30mA	30mA	30mA
	Typical Forward Current	$I_F$			20mA	20mA	20mA
	Forward Voltage	$V_F$			3.6V	3.5V	3.6V
	Reverse Peak Voltage	$V_{RM}$			5V	5V	5V
	Current Reduction Rate Above 25°C	$\Delta I_F$			0.50mA/°C		
Ambient Temperature Range				-25° ~ +50°C			

**No Code** No Lamp

### CAP TYPES & COLOR COMBINATIONS

Color Codes: B White C Red D Amber E Yellow F Green G Blue J Clear

#### Solid Cap for Incandescent Lamp & Nonilluminated

Lens/Filter

Colors Available:

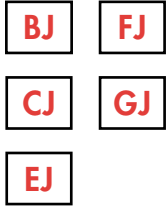

AT4054

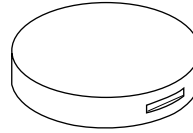
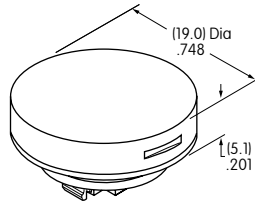

Translucent Colored Lens

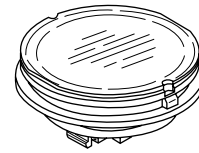

Transparent Clear Filter



Lamp AT607

Material: Polycarbonate Finish: Glossy

#### Insert Cap for Incandescent or Neon Lamp & Nonilluminated

Lens/Filter

Colors Available:

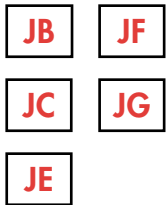

AT4055

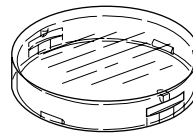
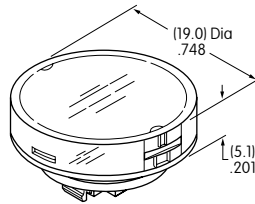

Transparent Clear Lens

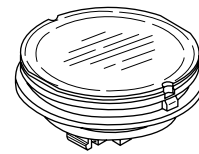

Translucent Colored Filter



Lamp AT607



Lamp AT607N

JF and JG not suitable with neon lamp.

Material: Polycarbonate Finish: Glossy

#### Cap for Bright LED without Resistor

Lens/Diffuser

Colors Available:



AT4179

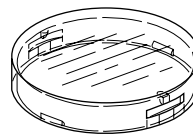
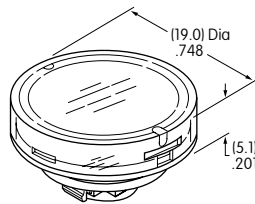

Transparent Clear Lens

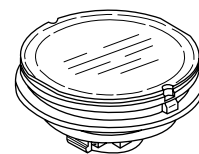

Translucent Colored Diffuser



Bright LED AT635

Material: Polycarbonate Finish: Glossy

#### Cap for Bright LED with Resistor

Lens/Diffuser

Colors Available:



AT4165

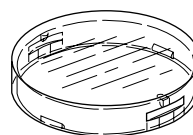
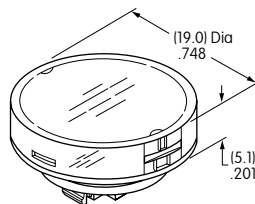

Transparent Clear Lens

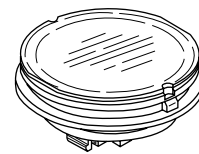

Translucent Colored Diffuser

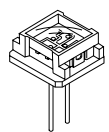

Bright LED AT627

Material: Polycarbonate Finish: Glossy

## CAP TYPES & COLOR COMBINATIONS

### Cap for Super Bright LEDs

**JB**

**Clear Lens  
White Diffuser**

Material:  
Polycarbonate  
Finish: Glossy

**AT4131**

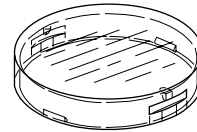
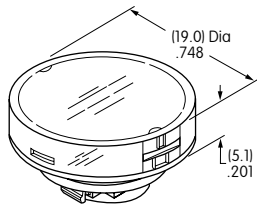

Transparent  
Clear Lens

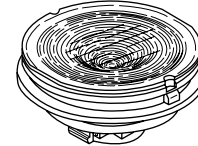

Translucent  
Colored Diffuser



LEDs  
AT625  
AT631  
AT632

## TYPICAL SWITCH DIMENSIONS

### Single & Double Pole

### Panel Seal

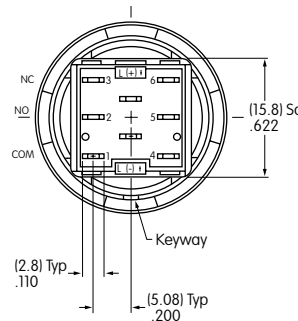
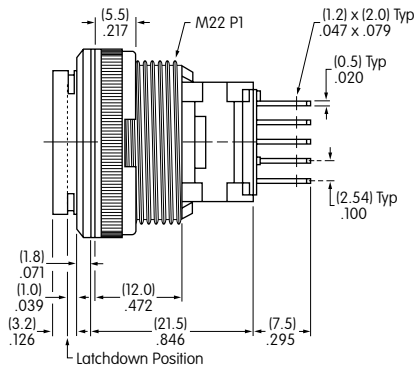
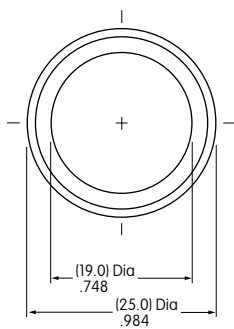

Single pole models do not have terminals 4, 5, & 6.

**LB25WKW01-12-JC**

## OPTIONAL ACCESSORIES

### AT9410 Splash Cover for Panel Seal

Materials:

Lid: PVC (loses pliability below 0°C/32°F)

Base: Polyethylene

O-ring: NBR

Recommended Panel Thickness:

.039" ~ .138" (1.0mm ~ 3.5mm)

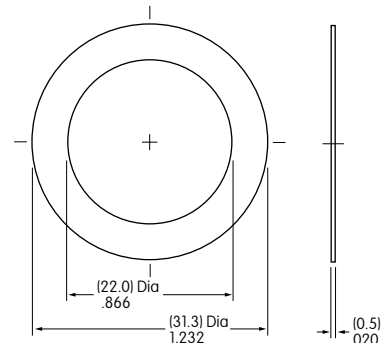
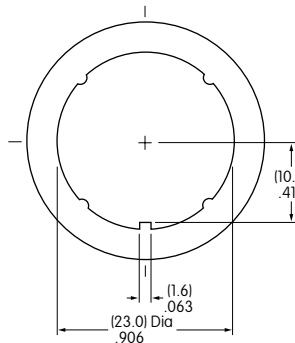
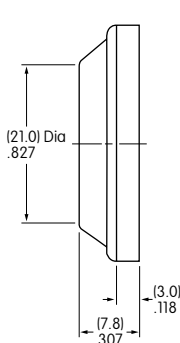
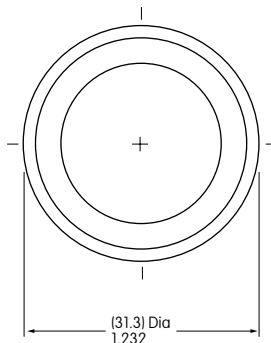
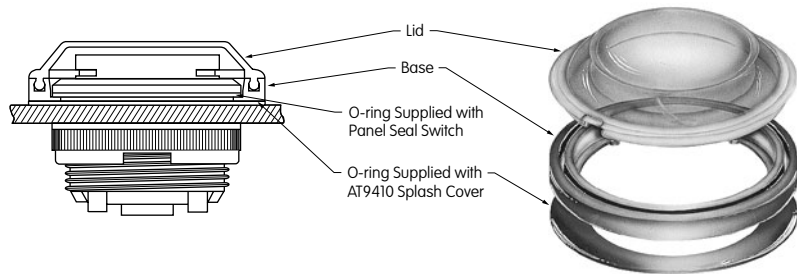

Toggles  
Rockers  
Pushbuttons  
Illuminated PB  
Programmable  
Keylocks  
Rotaries  
Slides  
Tactiles  
Tilt  
Touch  
Indicators  
Accessories  
Supplement

## ASSEMBLY INSTRUCTIONS

### Lamp Installation & LED Orientation

#### Incandescent & Neon Lamps AT607 & AT607N

Align projections on lamp with grooves (B) in holder when inserting lamp. To correctly join the lamp holder and cap base, match the cut corners (A).

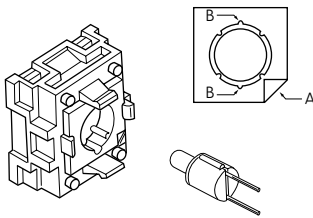

#### Bright LED AT627

##### Panel Seal Models

For panel seal models, Bright LED must first be inserted into the lamp socket which is built into the switch. The cap can then be placed on the switch.

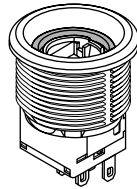

##### Snap-in Models

For snap-in models, Bright LED must be inserted into the cap first. Align cut corners (C) when inserting the LED.

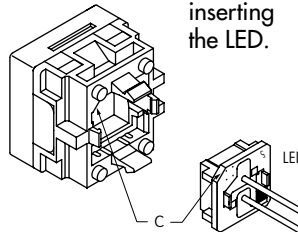

#### Bright & Super Bright LEDs AT625, AT631, AT632, AT635

Align D-flat on LED with flat (B) in holder when inserting the LED. To correctly join the lamp holder and cap base, match the cut corners (A).

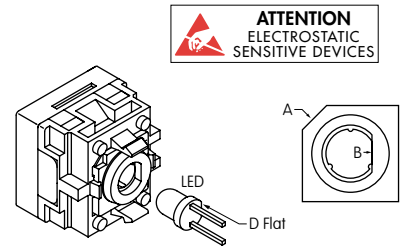

### Switch & Cap Assembly

#### Round & Rectangular

Match clip on cap assembly with receptacle inside switch. Lamp terminals will then be aligned correctly with lamp socket.

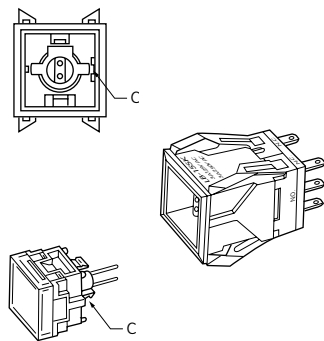
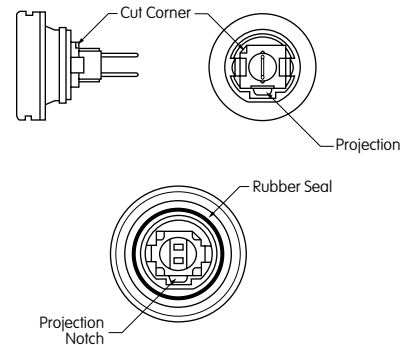

#### Square

Match projection (C) on cap assembly with groove (C) inside switch. Lamp terminals will then be aligned correctly with lamp socket.

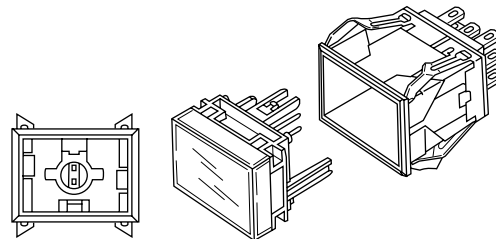

#### Panel Seal

With Lamps AT607, AT607N, and LEDs AT614, AT625, AT631, AT632: Match projection on cap assembly with notch inside switch. Lamp terminals will then be aligned correctly with lamp socket.

### Installation & Maintenance

#### Snap-in Mount

Snap-in clip holds all switches firmly in place. To mount round switch, match the antirotation projection on switch with guide cut in panel. Snap into panel cutout.

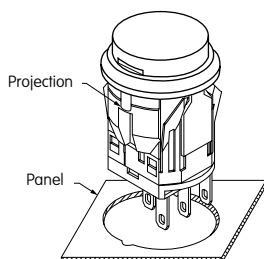

#### Panel Seal Bushing Mount

Insert switch from the front of the panel with the o-ring between the built-in bezel and the panel. Install mounting nut AT075 (supplied with switch) from the rear of the panel. Overtightening mounting nut may damage the switch housing.

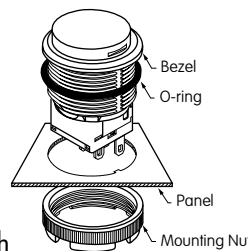

#### Lamp Replacement

Actuator must be in UP position. Pull off cap with cap extractor AT109. Replace lamp and reassemble as shown above.



AT109  
Cap Extractor



AT112  
Socket Wrench

Toggles  
Rockers  
Pushbuttons  
Illuminated PB  
Programmable  
Keylocks  
Rotaries  
Slides  
Tactiles  
Tilt  
Touch  
Indicators  
Accessories  
Supplement



## LEGENDS

NKK Switches can provide custom legends for caps. Contact factory for more information.

### Suggested Printable Area for Lens

**Recommended Methods:** Laser Etch on clear lens, Screen Print, or Pad Print on lens.

Epoxy based ink is recommended.

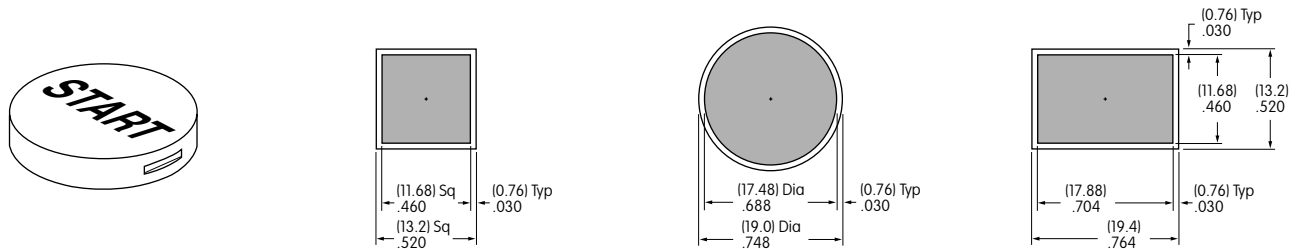

Shaded areas are printable areas.

### Suggested Printable Area for Film Insert

**Recommended Print Method:** Laser Print or Screen Print with Epoxy based ink

Film Insert: Clear Polyester, 4 mil max. thickness

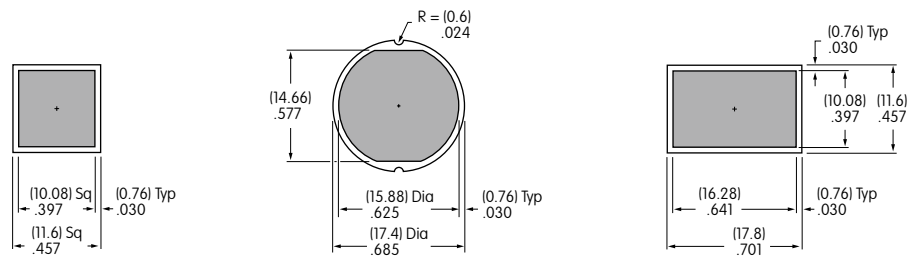
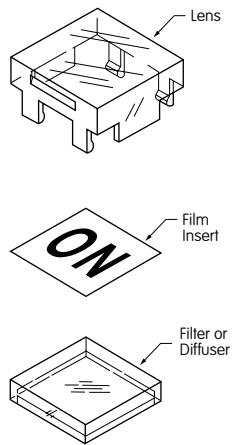

Shaded areas are printable areas.