

# Multi-Layer Ceramic Chip Inductors

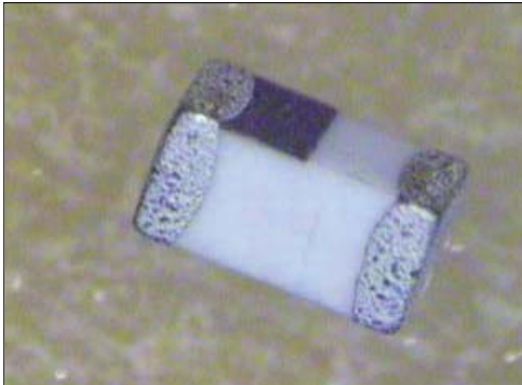

## LCMC Series



### APPLICATIONS

- High Frequency Applications:
  - Mobile Communications
  - WLAN
  - PHS
  - EMI Counter measure in High Frequency Circuits
  - Computer Communication

### FEATURES

- For high frequency applications
- Standard EIA sizes 0201 (0603), 0402 (1005), 0603 (1608)
- Lead-free RoHS compliant parts
- Tight tolerance in physical dimensions
- Surface mounting applicability (Supports reflow soldering condition)
- Tight Inductance Tolerance, Excellent Q and Guaranteed SRF range
- High product quality and outstanding reliability. (Ceramic integrated structure)
- Operating temperature -55°C to +125°C

### HOW TO ORDER

<b>LC</b>	<b>MC</b>	<b>0402</b>	<b>K</b>	<b>101</b>	<b>G</b>	<b>T</b>	<b>A</b>	<b>R</b>
<b>Family</b>	<b>Series</b>	<b>Size</b>	<b>Tolerance</b>	<b>Inductance</b>	<b>Style</b>	<b>Termination</b>	<b>Special</b>	<b>Packaging</b>
LC = Chip Inductor	MC = Multi-Layer	0201 0402 0603	G = 2% H = 3% J = 5% K = 10% B = 0.1nH C = 0.2nH S = 0.3nH	3N9 = 3.9nH 39N = 39nH R39 = 390nH	G = Standard	T = Sn Plating	A = Standard	R = 7" Reel

### DIMENSIONS

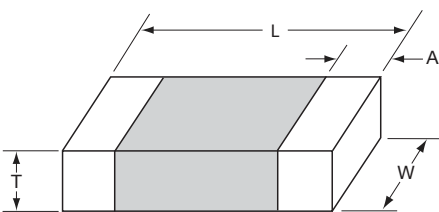

mm (inches)

Code	L	W	T	A	
				Min	Max
LCMC0201	0.60 ± 0.03 (0.024 ± 0.001)	0.30 ± 0.03 (0.012 ± 0.001)	0.30 ± 0.03 (0.012 ± 0.001)	0.10 (0.004)	0.20 (0.008)
LCMC0402	1.00 ± 0.10 (0.040 ± 0.004)	0.50 ± 0.10 (0.020 ± 0.004)	0.50 ± 0.10 (0.020 ± 0.004)	0.10 (0.004)	0.30 (0.012)
	1.60 ± 0.15 (0.063 ± 0.006)	0.80 ± 0.15 (0.031 ± 0.006)	0.80 ± 0.15 (0.031 ± 0.006)	0.20 (0.008)	0.60 (0.024)

### AVAILABLE INDUCTANCE VALUE AND TOLERANCE

Size Code	Available Inductance	Inductance Ranges	Standard Tolerance	Tolerance available upon request
LCMC0201	0.3nH - 100nH	0.3nH - 4.2nH	S=±0.3nH	B=±0.1nH, C=±0.2nH
		4.3nH - 6.2nH		B=±0.1nH, H=±3%
		6.8nH - 27nH	J=±5%	H=±3%
		33nH - 100nH	J=±5%	-
LCMC0402	0.6nH - 270nH	0.6 nH - 6.2 nH	S= ±0.3 nH	B= ±0.1 nH , C= ±0.2 nH
		6.8 nH - 82 nH	J= ±5%	G= ±2%, H=±3%
		100 nH - 270 nH	J= ±5%	-
LCMC0603	1.0 nH - 470 nH	1.0 nH - 5.6 nH	S= ±0.3 nH	B= ±0.1 nH, C= ±0.2 nH
		6.8 nH - 470 nH	J= ±5%	G= ±2%



# Multi-Layer High Frequency Ceramic Chip Inductors



## LCMC Series

### ELECTRICAL CHARACTERISTICS

0201										
Ordering Code	Inductance (nH)	Available Tolerance	Q Min.	L, Q Measuring Frequency (MHz)	Self-Resonance Frequency (MHz)		DC Resistance ( $\Omega$ )		Rated Current (mA) Max.	Packing Amount of 7" Reel Pcs
					Min.	Typ.	Max.	Typ.		
0N3	0.3	$\pm 0.3\text{nH}, \pm 0.2\text{nH}, \pm 0.1\text{nH}$	4	100	10,000	>13000	0.07	0.03	250	15000
0N4	0.4	$\pm 0.3\text{nH}, \pm 0.2\text{nH}, \pm 0.1\text{nH}$	4	100	10,000	>13000	0.07	0.04	250	
0N5	0.5	$\pm 0.3\text{nH}, \pm 0.2\text{nH}, \pm 0.1\text{nH}$	4	100	10,000	>13000	0.08	0.05	250	
0N6	0.6	$\pm 0.3\text{nH}, \pm 0.2\text{nH}, \pm 0.1\text{nH}$	4	100	10,000	>13000	0.08	0.05	250	
0N7	0.7	$\pm 0.3\text{nH}, \pm 0.2\text{nH}, \pm 0.1\text{nH}$	4	100	10,000	>13000	0.09	0.06	250	
0N8	0.8	$\pm 0.3\text{nH}, \pm 0.2\text{nH}, \pm 0.1\text{nH}$	4	100	10,000	>13000	0.10	0.07	250	
0N9	0.9	$\pm 0.3\text{nH}, \pm 0.2\text{nH}, \pm 0.1\text{nH}$	4	100	10,000	>13000	0.10	0.07	250	
1N0	1.0	$\pm 0.3\text{nH}, \pm 0.2\text{nH}, \pm 0.1\text{nH}$	4	100	10,000	>13000	0.14	0.09	250	
1N1	1.1	$\pm 0.3\text{nH}, \pm 0.2\text{nH}, \pm 0.1\text{nH}$	4	100	10,000	>13000	0.14	0.09	250	
1N2	1.2	$\pm 0.3\text{nH}, \pm 0.2\text{nH}, \pm 0.1\text{nH}$	4	100	10,000	>13000	0.14	0.09	250	
1N3	1.3	$\pm 0.3\text{nH}, \pm 0.2\text{nH}, \pm 0.1\text{nH}$	4	100	10,000	>13000	0.14	0.10	250	
1N5	1.5	$\pm 0.3\text{nH}, \pm 0.2\text{nH}, \pm 0.1\text{nH}$	4	100	10,000	>13000	0.18	0.10	230	
1N6	1.6	$\pm 0.3\text{nH}, \pm 0.2\text{nH}, \pm 0.1\text{nH}$	4	100	10,000	>13000	0.18	0.12	230	
1N8	1.8	$\pm 0.3\text{nH}, \pm 0.2\text{nH}, \pm 0.1\text{nH}$	4	100	10,000	>13000	0.19	0.13	200	
2N0	2.0	$\pm 0.3\text{nH}, \pm 0.2\text{nH}, \pm 0.1\text{nH}$	4	100	8,800	>13000	0.20	0.14	200	
2N1	2.1	$\pm 0.3\text{nH}, \pm 0.2\text{nH}, \pm 0.1\text{nH}$	4	100	8,800	>13000	0.20	0.15	200	
2N2	2.2	$\pm 0.3\text{nH}, \pm 0.2\text{nH}, \pm 0.1\text{nH}$	4	100	8,800	>13000	0.22	0.15	200	
2N4	2.4	$\pm 0.3\text{nH}, \pm 0.2\text{nH}, \pm 0.1\text{nH}$	4	100	8,300	11,700	0.24	0.15	200	
2N7	2.7	$\pm 0.3\text{nH}, \pm 0.2\text{nH}, \pm 0.1\text{nH}$	5	100	7,700	11,340	0.25	0.17	200	
3N0	3.0	$\pm 0.3\text{nH}, \pm 0.2\text{nH}, \pm 0.1\text{nH}$	5	100	7,200	11,000	0.28	0.20	180	
3N2	3.2	$\pm 0.3\text{nH}, \pm 0.2\text{nH}, \pm 0.1\text{nH}$	5	100	6,700	10,800	0.30	0.20	180	
3N3	3.3	$\pm 0.3\text{nH}, \pm 0.2\text{nH}, \pm 0.1\text{nH}$	5	100	6,700	10,400	0.30	0.20	180	
3N6	3.6	$\pm 0.3\text{nH}, \pm 0.2\text{nH}, \pm 0.1\text{nH}$	5	100	6,400	9,000	0.30	0.23	170	
3N9	3.9	$\pm 0.3\text{nH}, \pm 0.2\text{nH}, \pm 0.1\text{nH}$	5	100	6,000	8,790	0.30	0.23	170	
4N3	4.3	$\pm 0.3\text{nH}, 3\%, \pm 0.1\text{nH}$	5	100	5,700	8,000	0.40	0.24	150	
4N7	4.7	$\pm 0.3\text{nH}, 3\%, \pm 0.1\text{nH}$	5	100	5,300	7,750	0.40	0.26	150	
5N1	5.1	$\pm 0.3\text{nH}, 3\%, \pm 0.1\text{nH}$	5	100	5,000	7,210	0.40	0.26	150	
5N6	5.6	$\pm 0.3\text{nH}, 3\%, \pm 0.1\text{nH}$	5	100	4,200	6,680	0.40	0.32	150	
6N2	6.2	$\pm 0.3\text{nH}, 3\%, \pm 0.1\text{nH}$	5	100	3,800	6,800	0.44	0.32	150	
6N8	6.8	$\pm 5\%, \pm 3\%$	5	100	3,500	6,800	0.50	0.34	150	
7N5	7.5	$\pm 5\%, \pm 3\%$	5	100	3,300	6,000	0.53	0.36	150	
8N2	8.2	$\pm 5\%, \pm 3\%$	5	100	3,200	5,800	0.55	0.38	150	
9N1	9.1	$\pm 5\%, \pm 3\%$	5	100	3,000	5,000	0.62	0.38	150	
10N	10	$\pm 5\%, \pm 3\%$	5	100	2,800	4,860	0.65	0.40	150	
12N	12	$\pm 5\%, \pm 3\%$	5	100	2,400	4,520	0.70	0.50	100	
15N	15	$\pm 5\%, \pm 3\%$	5	100	2,200	4,820	0.80	0.60	100	
18N	18	$\pm 5\%, \pm 3\%$	5	100	2,200	3,000	0.90	0.85	100	
22N	22	$\pm 5\%, \pm 3\%$	5	100	1,800	2,950	1.20	0.86	100	
27N	27	$\pm 5\%, \pm 3\%$	4	100	1,800	2,610	1.80	0.88	50	
33N	33	$\pm 5\%$	4	100	1,700	2,210	2.10	1.05	50	
39N	39	$\pm 5\%$	4	100	1,500	1,860	2.40	1.18	50	
47N	47	$\pm 5\%$	4	100	1,300	1,800	2.80	1.74	100	
56N	56	$\pm 5\%$	4	100	1,100	1,600	3.00	1.85	80	
68N	68	$\pm 5\%$	4	100	1,100	1,500	2.66	2.30	80	
82N	82	$\pm 5\%$	4	100	1,000	1,400	3.37	2.60	70	
R10	100	$\pm 5\%$	4	100	900	1,200	3.74	3.00	60	

Tolerance: B =  $\pm 0.1\text{nH}$ , C =  $\pm 0.2\text{nH}$ , S =  $\pm 0.3\text{nH}$ , G =  $\pm 2\%$ , H =  $\pm 3\%$ , J =  $\pm 5\%$ , K =  $\pm 10\%$   
 Measuring Equipment: HP4287+16196C  
 Measuring Temperature:  $25 \pm 3^\circ\text{C}$  Operating  
 Temperature:  $-55^\circ\text{C}$  to  $+125^\circ\text{C}$



# Multi-Layer High Frequency Ceramic Chip Inductors



## LCMC Series

### L, Q VS. FREQUENCY CHARACTERISTICS

0201														
Ordering Code	Typical Inductance (nH)							Typical Q						
	100 MHz	500 MHz	800 MHz	900 MHz	1.8 GHz	2.0 GHz	2.4 GHz	100 MHz	500 MHz	800 MHz	900 MHz	1.8 GHz	2.0 GHz	2.4 GHz
0N3	0.3	0.3	0.3	0.3	0.3	0.3	0.3	6	14	19	20	32	35	39
0N4	0.4	0.4	0.4	0.4	0.4	0.4	0.4	6	14	19	20	32	35	39
0N5	0.5	0.5	0.5	0.5	0.5	0.5	0.5	6	14	19	20	33	36	40
0N6	0.6	0.6	0.5	0.5	0.5	0.5	0.5	6	15	19	20	33	36	40
0N7	0.7	0.7	0.6	0.6	0.6	0.6	0.6	6	15	20	21	34	37	41
0N8	0.8	0.8	0.7	0.7	0.7	0.7	0.7	6	14	19	20	32	35	39
0N9	0.9	0.8	0.8	0.8	0.8	0.8	0.8	6	15	20	21	35	37	42
1N0	1.0	0.9	0.9	0.9	0.9	0.9	0.9	5	13	17	18	28	30	33
1N1	1.1	1.0	1.0	1.0	0.9	0.9	0.9	6	14	18	20	30	32	34
1N2	1.2	1.2	1.2	1.2	1.2	1.2	1.2	6	14	18	19	28	30	32
1N3	1.3	1.2	1.2	1.2	1.2	1.2	1.2	6	13	17	18	27	28	31
1N5	1.5	1.4	1.3	1.3	1.4	1.4	1.4	6	14	18	20	30	32	34
1N6	1.6	1.6	1.6	1.6	1.6	1.6	1.6	6	14	18	20	28	30	31
1N8	1.8	1.7	1.7	1.7	1.7	1.7	1.7	6	14	18	20	28	30	31
2N0	2.0	1.9	1.9	1.9	2.0	1.9	2.0	6	14	18	19	28	29	31
2N1	2.1	2.0	1.9	1.9	2.0	2.0	2.1	6	13	17	18	26	28	30
2N2	2.2	2.1	2.0	2.0	2.1	2.1	2.2	6	13	17	18	26	28	30
2N4	2.4	2.3	2.2	2.2	2.3	2.4	2.5	6	14	18	20	28	29	31
2N7	2.7	2.5	2.5	2.5	2.6	2.7	2.8	6	14	18	19	28	29	31
3N0	3.0	2.8	2.8	2.8	2.9	2.9	3.0	7	15	19	21	30	31	33
3N2	3.2	3.0	3.0	3.0	3.1	3.1	3.2	6	14	19	20	29	30	32
3N3	3.3	3.2	3.1	3.2	3.0	3.4	3.5	6	14	19	20	29	30	32
3N6	3.6	3.4	3.4	3.4	3.7	3.7	3.9	6	14	18	20	28	29	31
3N9	3.9	3.7	3.7	3.7	3.9	4.0	4.2	6	15	19	20	28	29	31
4N3	4.3	4.1	4.1	4.1	4.4	4.9	4.8	6	14	18	19	27	28	29
4N7	4.7	4.4	4.4	4.4	4.8	4.9	5.2	6	14	19	19	26	27	29
5N1	5.1	4.9	4.9	4.9	5.4	5.6	6.0	6	13	17	18	25	25	26
5N6	5.6	5.3	5.3	5.3	5.8	6.0	6.6	7	14	18	19	26	27	27
6N2	6.2	6.0	6.0	6.1	6.9	7.2	8.1	6	14	18	19	26	26	30
6N8	6.8	6.3	6.4	6.4	7.2	7.4	8.2	7	14	18	19	26	26	26
7N5	7.5	7.1	7.2	7.2	8.3	8.7	9.8	6	15	18	20	25	25	25
8N2	8.2	7.8	7.9	8.0	9.2	9.7	11.0	7	15	18	19	19	24	24
9N1	9.1	8.7	8.8	8.9	10.8	11.6	13.9	6	13	16	17	21	20	18
10N	10.0	9.3	9.5	9.6	12.0	13.0	16.1	6	13	16	17	20	20	18
12N	12.0	11.3	11.5	11.7	15.4	17.2	23.2	7	13	16	17	18	17	14
15N	15.0	14.5	15.1	15.4	22.4	26.2	42.3	7	15	18	19	19	17	11
18N	18.0	17.2	18.1	18.6	31.1	39.5	99.3	7	13	16	16	14	11	5
22N	22.0	21.4	22.8	23.5	45.5	64.1	-	7	13	16	16	12	8	-
27N	27.0	26.6	29.2	30.6	108.5	-	-	6	13	15	15	6	-	-
33N	33.0	31.9	34.8	36.0	119.0	-	-	7	14	16	17	6	-	-
39N	39.0	38.2	42.3	45.6	-	-	-	6	12	13	13	-	-	-
47N	47.0	44.0	47.0	49.0	-	-	-	6	11	12	11	-	-	-
56N	56.0	54.0	61.0	66.0	-	-	-	6	11	11	10	-	-	-
68N	68.0	66.0	76.0	82.0	-	-	-	6	11	11	10	-	-	-
82N	82.0	80.0	97.0	108.0	-	-	-	6	11	10	8	-	-	-
R10	100.0	103.0	138.0	164.0	-	-	-	6	10	9	6	-	-	-

Tolerance: B =  $\pm 0.1\text{nH}$ , C =  $\pm 0.2\text{nH}$ , S =  $\pm 0.3\text{nH}$ , G =  $\pm 2\%$ , H =  $\pm 3\%$ , J =  $\pm 5\%$ , K =  $\pm 10\%$   
 Measuring Equipment: HP4287+16196C  
 Measuring Temperature:  $25 \pm 3^\circ\text{C}$   
 Operating Temperature:  $-55^\circ\text{C}$  to  $+125^\circ\text{C}$

# Multi-Layer High Frequency Ceramic Chip Inductors



## LCMC Series

0201 L VS FREQUENCY

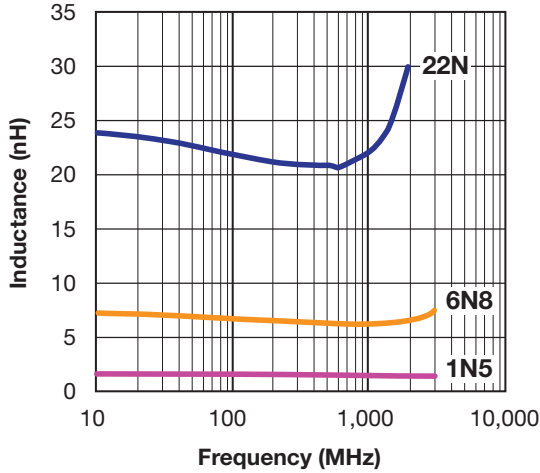

0201 Q VS FREQUENCY

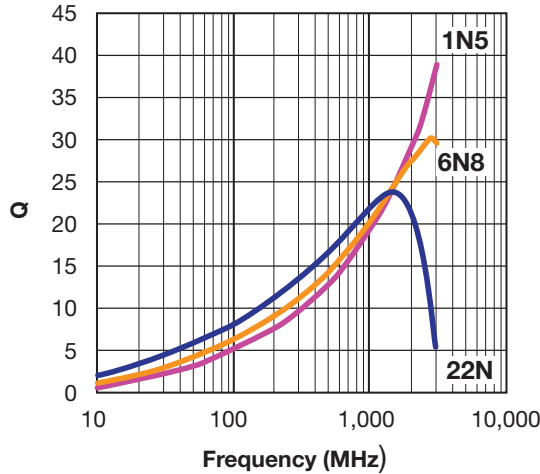

0201 Z VS FREQUENCY

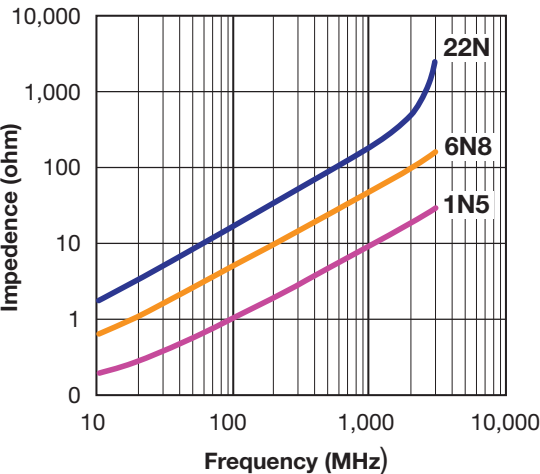

# Multi-Layer High Frequency Ceramic Chip Inductors



## LCMC Series

### ELECTRICAL CHARACTERISTICS

0402										
Ordering Code	Inductance (nH)	Available Tolerance	Q Min.	L, Q Measuring Frequency (MHz)	Self-Resonance Frequency (MHz)		DC Resistance ( $\Omega$ )		Rated Current (mA) Max.	Packing Amount of 7" Reel Pcs
					Min.	Typ.	Max.	Typ.		
0N6	0.6	$\pm 0.3\text{nH}, \pm 0.2\text{nH}, \pm 0.1\text{nH}$	8	100	10000	>13000	0.08	0.02	300	10,000
1N0	1.0	$\pm 0.3\text{nH}, \pm 0.2\text{nH}, \pm 0.1\text{nH}$	8	100	10000	>13000	0.08	0.02	300	
1N1	1.1	$\pm 0.3\text{nH}, \pm 0.2\text{nH}, \pm 0.1\text{nH}$	8	100	10000	>13000	0.08	0.03	300	
1N2	1.2	$\pm 0.3\text{nH}, \pm 0.2\text{nH}, \pm 0.1\text{nH}$	8	100	10000	>13000	0.09	0.03	300	
1N3	1.3	$\pm 0.3\text{nH}, \pm 0.2\text{nH}, \pm 0.1\text{nH}$	8	100	10000	>13000	0.09	0.04	300	
1N5	1.5	$\pm 0.3\text{nH}, \pm 0.2\text{nH}, \pm 0.1\text{nH}$	8	100	10000	>13000	0.10	0.05	300	
1N6	1.6	$\pm 0.3\text{nH}, \pm 0.2\text{nH}, \pm 0.1\text{nH}$	8	100	10000	>13000	0.10	0.05	300	
1N8	1.8	$\pm 0.3\text{nH}, \pm 0.2\text{nH}, \pm 0.1\text{nH}$	8	100	6000	12220	0.12	0.05	300	
2N0	2.0	$\pm 0.3\text{nH}, \pm 0.2\text{nH}, \pm 0.1\text{nH}$	8	100	6000	12890	0.12	0.06	300	
2N2	2.2	$\pm 0.3\text{nH}, \pm 0.2\text{nH}, \pm 0.1\text{nH}$	8	100	6000	12430	0.13	0.06	300	
2N4	2.4	$\pm 0.3\text{nH}, \pm 0.2\text{nH}, \pm 0.1\text{nH}$	8	100	6000	12320	0.13	0.07	300	
2N7	2.7	$\pm 0.3\text{nH}, \pm 0.2\text{nH}, \pm 0.1\text{nH}$	8	100	6000	10070	0.16	0.09	300	
3N0	3.0	$\pm 0.3\text{nH}, \pm 0.2\text{nH}, \pm 0.1\text{nH}$	8	100	6000	8760	0.16	0.09	300	
3N3	3.3	$\pm 0.3\text{nH}, \pm 0.2\text{nH}, \pm 0.1\text{nH}$	8	100	6000	8120	0.16	0.09	300	
3N6	3.6	$\pm 0.3\text{nH}, \pm 0.2\text{nH}, \pm 0.1\text{nH}$	8	100	5000	8200	0.20	0.10	300	
3N9	3.9	$\pm 0.3\text{nH}, \pm 0.2\text{nH}, \pm 0.1\text{nH}$	8	100	4000	8390	0.20	0.10	300	
4N3	4.3	$\pm 0.3\text{nH}, \pm 0.2\text{nH}, \pm 0.1\text{nH}$	8	100	4000	7500	0.20	0.11	300	
4N7	4.7	$\pm 0.3\text{nH}, \pm 0.2\text{nH}, \pm 0.1\text{nH}$	8	100	4000	7010	0.20	0.11	300	
5N1	5.1	$\pm 0.3\text{nH}, \pm 0.2\text{nH}, \pm 0.1\text{nH}$	8	100	4000	6340	0.23	0.13	300	
5N6	5.6	$\pm 0.3\text{nH}, \pm 0.2\text{nH}, \pm 0.1\text{nH}$	8	100	4000	5760	0.23	0.13	300	
6N2	6.2	$\pm 0.3\text{nH}, \pm 0.2\text{nH}, \pm 0.1\text{nH}$	8	100	3900	5490	0.25	0.15	300	
6N8	6.8	$\pm 5\%, \pm 3\%, \pm 2\%$	8	100	3900	5430	0.25	0.14	300	
7N5	7.5	$\pm 5\%, \pm 3\%, \pm 2\%$	8	100	3700	5000	0.28	0.16	300	
8N2	8.2	$\pm 5\%, \pm 3\%, \pm 2\%$	8	100	3500	4660	0.28	0.17	300	
9N1	9.1	$\pm 5\%, \pm 3\%, \pm 2\%$	8	100	3400	4400	0.30	0.22	300	
10N	10	$\pm 5\%, \pm 3\%, \pm 2\%$	8	100	3200	4120	0.31	0.24	300	
12N	12	$\pm 5\%, \pm 3\%, \pm 2\%$	8	100	2600	3820	0.45	0.30	300	
15N	15	$\pm 5\%, \pm 3\%, \pm 2\%$	8	100	2300	3350	0.55	0.38	300	
18N	18	$\pm 5\%, \pm 3\%, \pm 2\%$	8	100	2000	2970	0.65	0.37	300	
22N	22	$\pm 5\%, \pm 3\%, \pm 2\%$	8	100	1600	2640	0.70	0.45	300	
27N	27	$\pm 5\%, \pm 3\%, \pm 2\%$	8	100	1400	2370	0.80	0.49	300	
33N	33	$\pm 5\%, \pm 3\%, \pm 2\%$	8	100	1200	2040	0.90	0.63	200	
39N	39	$\pm 5\%, \pm 3\%, \pm 2\%$	8	100	1100	1800	1.00	0.70	200	
47N	47	$\pm 5\%, \pm 3\%, \pm 2\%$	8	100	900	1660	1.10	0.82	200	
56N	56	$\pm 5\%, \pm 3\%, \pm 2\%$	8	100	750	1560	1.10	0.84	200	
68N	68	$\pm 5\%, \pm 3\%, \pm 2\%$	8	100	750	1330	1.20	0.99	180	
82N	82	$\pm 5\%, \pm 3\%, \pm 2\%$	8	100	600	1160	1.30	1.09	150	
R10	100	$\pm 5\%$	8	100	600	1020	1.60	1.19	150	
R12	120	$\pm 5\%$	8	100	600	860	1.60	1.31	150	
R15	150	$\pm 5\%$	8	100	550	800	2.40	1.58	140	
R18	180	$\pm 5\%$	8	100	500	810	3.70	2.97	130	
R22	220	$\pm 5\%$	8	100	450	700	4.20	3.29	120	
R27	270	$\pm 5\%$	8	100	400	600	4.80	3.92	110	

Tolerance: B =  $\pm 0.1\text{nH}$ , C =  $\pm 0.2\text{nH}$ , S =  $\pm 0.3\text{nH}$ , G =  $\pm 2\%$ , H =  $\pm 3\%$ , J =  $\pm 5\%$ , K =  $\pm 10\%$   
 Measuring Equipment: HP4287+16196C  
 Measuring Temperature:  $25 \pm 3^\circ\text{C}$   
 Operating Temperature:  $-55^\circ\text{C}$  to  $+125^\circ\text{C}$



# Multi-Layer High Frequency Ceramic Chip Inductors



## LCMC Series

### L, Q VS. FREQUENCY CHARACTERISTICS

0402														
Ordering Code	Typical Inductance (nH)							Typical Q						
	100 MHz	500 MHz	800 MHz	900 MHz	1.8 GHz	2.0 GHz	2.4 GHz	100 MHz	500 MHz	800 MHz	900 MHz	1.8 GHz	2.0 GHz	2.4 GHz
0N6	0.6	0.6	0.6	0.6	0.6	0.6	0.6	12	40	60	65	100	120	140
1N0	1.0	1.0	1.0	1.0	1.0	1.0	1.0	12	29	38	41	63	71	75
1N1	1.1	1.1	1.1	1.1	1.1	1.1	1.1	11	29	37	40	60	67	72
1N2	1.2	1.2	1.2	1.2	1.2	1.2	1.2	11	29	38	41	61	68	73
1N3	1.3	1.3	1.3	1.3	1.3	1.3	1.3	11	30	38	41	61	67	72
1N5	1.5	1.5	1.5	1.5	1.5	1.5	1.5	11	27	35	38	57	63	68
1N6	1.6	1.5	1.5	1.5	1.5	1.5	1.5	11	28	35	38	57	64	68
1N8	1.8	1.7	1.7	1.7	1.7	1.7	1.8	11	26	33	36	53	58	61
2N0	2.0	2.0	2.0	2.0	2.0	2.1	2.1	10	23	29	31	45	49	52
2N2	2.2	2.1	2.1	2.1	2.2	2.2	2.2	10	24	31	33	48	52	55
2N4	2.4	2.3	2.3	2.3	2.4	2.4	2.4	10	25	31	34	49	53	57
2N7	2.7	2.7	2.7	2.7	2.8	2.8	2.9	11	27	35	37	54	58	60
3N0	3.0	2.9	2.9	3.0	3.1	3.1	3.2	10	25	32	34	49	53	55
3N3	3.3	3.2	3.2	3.2	3.4	3.4	3.5	11	25	32	35	50	54	56
3N6	3.6	3.5	3.5	3.5	3.7	3.8	3.9	10	24	31	33	46	49	49
3N9	3.9	3.7	3.7	3.8	3.9	4.0	4.1	11	24	30	33	46	49	51
4N3	4.3	4.1	4.2	4.2	4.4	4.4	4.6	11	26	33	35	50	53	54
4N7	4.7	4.5	4.5	4.5	4.8	4.9	5.1	11	25	32	35	49	51	53
5N1	5.1	4.9	4.9	4.9	5.2	5.3	5.6	11	25	32	35	46	48	49
5N6	5.6	5.5	5.5	5.5	6.0	6.2	6.7	11	25	32	35	46	48	49
6N2	6.2	6.1	6.1	6.1	6.7	6.8	7.3	11	26	32	34	46	48	49
6N8	6.8	6.6	6.7	6.7	7.4	7.6	8.2	11	26	32	35	46	48	48
7N5	7.5	7.1	7.2	7.3	7.8	8.1	8.8	11	26	32	35	46	48	48
8N2	8.2	8.0	8.1	8.2	9.4	9.9	11.1	11	26	32	34	42	42	40
9N1	9.1	8.7	8.8	8.8	9.9	10.2	11.1	11	25	31	34	42	42	40
10N	10.0	10.0	9.8	9.9	11.7	12.4	14.4	11	23	29	31	37	37	34
12N	12.0	11.7	12.0	12.2	15.1	16.3	20.1	11	24	31	33	37	36	30
15N	15.0	14.9	15.5	15.8	22.8	26.4	41.8	11	23	30	32	35	33	28
18N	18.0	17.8	18.4	18.7	24.9	27.7	37.7	11	23	28	29	30	28	22
22N	22.0	21.8	23.1	23.8	40.9	52.7	156.0	11	22	27	28	22	18	6
27N	27.0	27.1	29.2	30.3	66.8	106.9	-	11	22	26	27	16	11	4
33N	33.0	33.2	36.3	37.9	109.0	259.0	-	11	22	25	26	12	5	-
39N	39.0	40.2	45.9	49.1	-	-	-	11	20	22	22	-	-	-
47N	47.0	49.1	57.2	61.7	-	-	-	11	20	21	21	-	-	-
56N	56.0	59.2	71.8	79.3	-	-	-	11	19	19	18	-	-	-
68N	68.0	74.7	99.4	116.3	-	-	-	11	18	17	15	-	-	-
82N	82.0	94.7	140.8	179.5	-	-	-	11	18	15	12	-	-	-
R10	100.0	117.6	193.7	269.9	-	-	-	11	17	12	9	-	-	-
R12	120.0	159.8	450.4	-	-	-	-	11	16	7	-	-	-	-
R15	150.0	207.2	-	-	-	-	-	11	14	-	-	-	-	-
R18	180.0	-	-	-	-	-	-	12	-	-	-	-	-	-
R22	220.0	-	-	-	-	-	-	12	-	-	-	-	-	-
R27	270.0	-	-	-	-	-	-	12	-	-	-	-	-	-

# Multi-Layer High Frequency Ceramic Chip Inductors



## LCMC Series

0402 L VS FREQUENCY

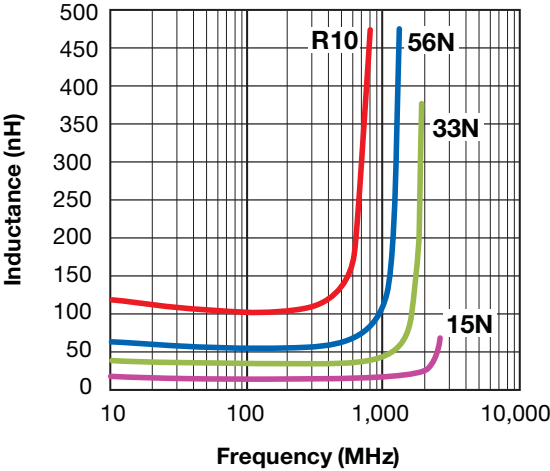

0402 Q VS FREQUENCY

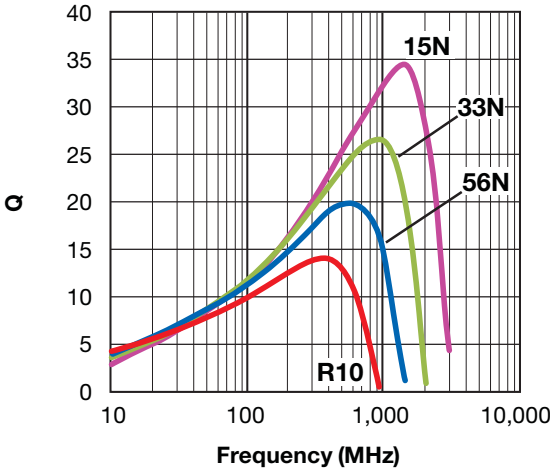

0402 Z VS FREQUENCY

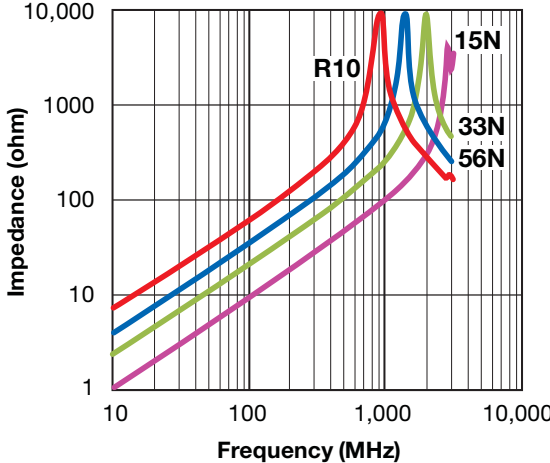

# Multi-Layer High Frequency Ceramic Chip Inductors



## LCMC Series

### ELECTRICAL CHARACTERISTICS

#### 0603

Ordering Code	Inductance (nH)	Available Tolerance	Q Min.	L, Q Measuring Frequency (MHz)	Self-Resonance Frequency (MHz)		DC Resistance ( $\Omega$ )		Rated Current (mA) Max.	Packing Amount of 7" Reel Pcs
					Min.	Typ.	Max.	Typ.		
1N0	1.0	$\pm 0.3\text{nH}, \pm 0.2\text{nH}, \pm 0.1\text{nH}$	8	100	10000	>13000	0.05	0.01	1000	4,000
1N2	1.2	$\pm 0.3\text{nH}, \pm 0.2\text{nH}, \pm 0.1\text{nH}$	8	100	10000	>13000	0.05	0.02	1000	
1N5	1.5	$\pm 0.3\text{nH}, \pm 0.2\text{nH}, \pm 0.1\text{nH}$	8	100	10000	>13000	0.10	0.03	1000	
1N8	1.8	$\pm 0.3\text{nH}, \pm 0.2\text{nH}, \pm 0.1\text{nH}$	8	100	10000	>13000	0.10	0.04	1000	
2N2	2.2	$\pm 0.3\text{nH}, \pm 0.2\text{nH}, \pm 0.1\text{nH}$	8	100	6000	11690	0.10	0.05	1000	
2N7	2.7	$\pm 0.3\text{nH}, \pm 0.2\text{nH}, \pm 0.1\text{nH}$	10	100	6000	8930	0.13	0.06	1000	
3N3	3.3	$\pm 0.3\text{nH}, \pm 0.2\text{nH}, \pm 0.1\text{nH}$	10	100	6000	6440	0.13	0.07	1000	
3N9	3.9	$\pm 0.3\text{nH}, \pm 0.2\text{nH}, \pm 0.1\text{nH}$	10	100	6000	7280	0.15	0.08	1000	
4N7	4.7	$\pm 0.3\text{nH}, \pm 0.2\text{nH}, \pm 0.1\text{nH}$	10	100	4000	6470	0.20	0.09	1000	
5N6	5.6	$\pm 0.3\text{nH}, \pm 0.2\text{nH}, \pm 0.1\text{nH}$	10	100	4000	5230	0.23	0.10	600	
6N8	6.8	$\pm 5\%, \pm 2\%$	10	100	4000	5470	0.25	0.11	600	
8N2	8.2	$\pm 5\%, \pm 2\%$	10	100	3500	4460	0.28	0.14	600	
10N	10	$\pm 5\%, \pm 2\%$	12	100	3200	4360	0.30	0.15	600	
12N	12	$\pm 5\%, \pm 2\%$	12	100	2600	3480	0.35	0.17	600	
15N	15	$\pm 5\%, \pm 2\%$	12	100	2300	3310	0.40	0.19	600	
18N	18	$\pm 5\%, \pm 2\%$	12	100	2000	3080	0.45	0.21	600	
22N	22	$\pm 5\%, \pm 2\%$	12	100	1600	2670	0.50	0.29	600	
27N	27	$\pm 5\%, \pm 2\%$	12	100	1400	2270	0.55	0.27	600	
33N	33	$\pm 5\%, \pm 2\%$	12	100	1200	1970	0.60	0.36	600	
39N	39	$\pm 5\%, \pm 2\%$	12	100	1100	1830	0.65	0.37	500	
47N	47	$\pm 5\%, \pm 2\%$	12	100	900	1670	0.70	0.47	500	
56N	56	$\pm 5\%, \pm 2\%$	12	100	900	1530	0.75	0.46	500	
68N	68	$\pm 5\%, \pm 2\%$	12	100	700	1360	0.85	0.51	400	
82N	82	$\pm 5\%, \pm 2\%$	12	100	600	1290	0.95	0.57	300	
R10	100	$\pm 5\%, \pm 2\%$	12	100	600	1090	1.00	0.69	300	
R12	120	$\pm 5\%, \pm 2\%$	8	50	500	1030	1.20	0.74	300	
R15	150	$\pm 5\%, \pm 2\%$	8	50	500	820	1.20	0.78	300	
R18	180	$\pm 5\%, \pm 2\%$	8	50	400	690	1.30	0.92	300	
R22	220	$\pm 5\%, \pm 2\%$	8	50	400	630	1.50	1.19	300	
R24	240	$\pm 5\%, \pm 2\%$	8	50	400	600	1.70	1.20	200	
R27	270	$\pm 5\%, \pm 2\%$	8	50	400	520	1.90	1.30	150	
R33R	330	$\pm 5\%, \pm 2\%$	8	50	350	450	2.10	1.50	150	
R39	390	$\pm 5\%, \pm 2\%$	8	50	350	400	2.30	1.80	150	
R47	470	$\pm 5\%, \pm 2\%$	8	50	300	360	2.60	2.04	150	

Tolerance: B =  $\pm 0.1\text{nH}$ , C =  $\pm 0.2\text{nH}$ , S =  $\pm 0.3\text{nH}$ , G =  $\pm 2\%$ , H =  $\pm 3\%$ , J =  $\pm 5\%$ , K =  $\pm 10\%$

Measuring Equipment: HP4291B+16192A

Measuring Temperature:  $25 \pm 3^\circ\text{C}$

Operating Temperature:  $-40^\circ\text{C}$  to  $+125^\circ\text{C}$



# Multi-Layer High Frequency Ceramic Chip Inductors



## LCMC Series

### L, Q VS. FREQUENCY CHARACTERISTICS

0603														
Ordering Code	Typical Inductance (nH)							Typical Q						
	100 MHz	500 MHz	800 MHz	900 MHz	1.8 GHz	2.0 GHz	2.4 GHz	100 MHz	500 MHz	800 MHz	900 MHz	1.8 GHz	2.0 GHz	2.4 GHz
1N0	1.0	1.1	1.1	1.1	1.1	1.1	1.0	14	40	53	60	93	32	174
1N2	1.2	1.2	1.2	1.2	1.2	1.2	1.1	14	38	49	54	84	32	143
1N5	1.5	1.6	1.6	1.6	1.6	1.5	1.5	12	31	39	43	62	33	88
1N8	1.8	1.8	1.8	1.8	1.8	1.8	1.7	13	34	42	46	68	37	97
2N2	2.2	2.2	2.2	2.2	2.2	2.2	2.2	14	36	46	50	73	42	101
2N7	2.7	2.7	2.7	2.7	2.7	2.7	2.7	14	36	47	45	72	45	94
3N3	3.3	3.3	3.3	3.3	3.5	3.5	3.6	14	37	47	50	67	47	77
3N9	3.9	3.9	3.9	3.9	4.0	4.0	4.1	15	36	46	49	66	48	81
4N7	4.7	4.6	4.6	4.7	4.9	4.9	5.1	15	39	50	53	70	53	80
5N6	5.6	5.5	5.6	5.6	6.1	6.3	6.7	15	39	50	54	67	52	69
6N8	6.8	6.7	6.7	6.8	7.3	7.5	7.9	15	38	49	52	66	53	66
8N2	8.2	8.1	8.2	8.3	9.5	9.9	11.0	16	37	48	50	59	49	54
10N	10.0	9.9	10.1	10.2	11.7	12.3	13.9	16	39	49	52	60	50	52
12N	12.0	12.2	12.6	12.8	16.6	18.4	24.4	16	36	46	48	47	39	31
15N	15.0	15.1	15.6	15.9	21.0	23.4	31.9	17	40	50	52	49	41	31
18N	18.0	18.1	18.9	19.3	27.7	32.2	52.2	17	39	48	50	43	35	21
22N	22.0	22.3	23.8	24.6	45.7	63.5	521.1	17	39	46	47	29	19	1
27N	27.0	27.8	30.3	31.6	85.8	191.2	-	18	39	45	46	19	8	-
33N	33.0	34.9	38.8	40.9	-	-	-	18	39	43	43	-	-	-
39N	39.0	41.3	47.7	51.2	-	-	-	19	36	39	37	-	-	-
47N	47.0	50.0	58.9	64.0	-	-	-	17	34	36	34	-	-	-
56N	56.0	62.0	77.7	87.5	-	-	-	19	35	34	31	-	-	-
68N	68.0	76.8	103.2	121.7	-	-	-	18	33	29	25	-	-	-
82N	82.0	96.5	145.3	187.2	-	-	-	19	32	25	20	-	-	-
R10	100.0	123.7	222.4	343.5	-	-	-	18	30	19	12	-	-	-
R12	120.0	156.0	355.0	-	-	-	-	19	28	14	-	-	-	-
R15	150.0	227.9	-	-	-	-	-	18	21	-	-	-	-	-
R18	180.0	336.8	-	-	-	-	-	17	17	-	-	-	-	-
R22	220.0	520.7	-	-	-	-	-	16	13	-	-	-	-	-
R24	240.0	-	-	-	-	-	-	16	-	-	-	-	-	-
R27	270.0	-	-	-	-	-	-	16	-	-	-	-	-	-
R33R	330.0	-	-	-	-	-	-	14	-	-	-	-	-	-
R39	390.0	-	-	-	-	-	-	14	-	-	-	-	-	-
R47	470.0	-	-	-	-	-	-	13	-	-	-	-	-	-



# Multi-Layer High Frequency Ceramic Chip Inductors



## LCMC Series

### 0603 L VS FREQUENCY

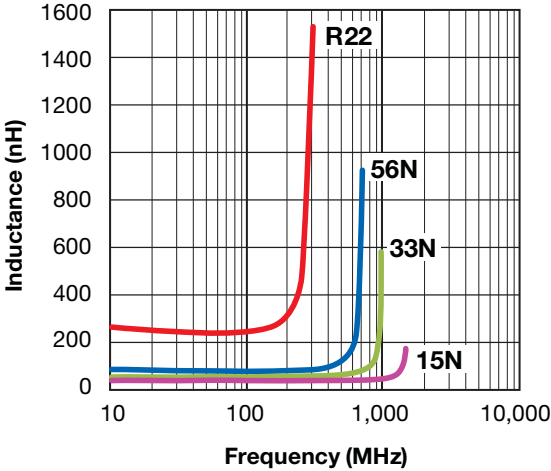

### 0603 Q VS FREQUENCY

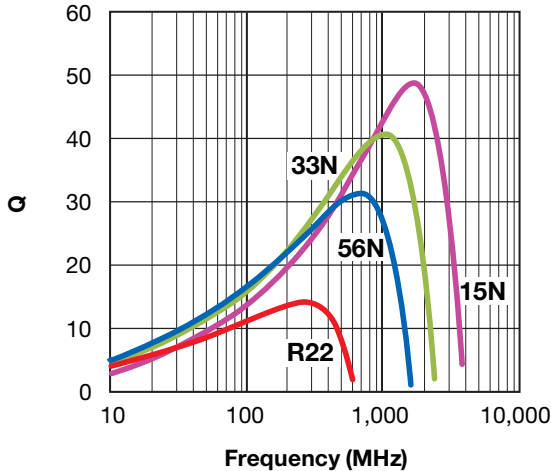

### 0603 Z VS FREQUENCY

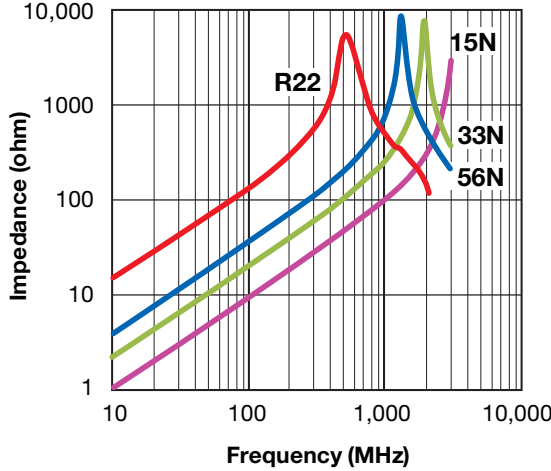



# Multi-Layer High Frequency Ceramic Chip Inductors

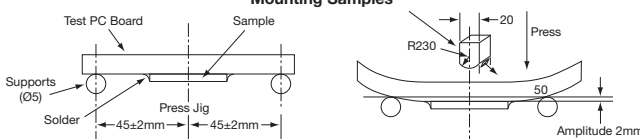

## LCMC Series

### TEST CONDITION AND REQUIREMENTS

No.	Item	Test Condition	Requirements
1	Inductance	a. Temperature: $25 \pm 3^\circ\text{C}$ b. Relative Humidity: 45 to 75%RH c. Measuring equipment and fixture: (0603) HP 4291+16192A (0402) HP 4287+16193A (0201) HP 4287+16196C	Within specified tolerance.
2	Q Value	a. Temperature: $25 \pm 3^\circ\text{C}$ b. Relative Humidity: 45 to 75%RH c. Measuring equipment and fixture: (0603) HP 4291+16192A (0402) HP 4287+16193A (0201) HP 4287+16196C	In accordance with electrical specification.
3	DC Resistance	a. Temperature: $25 \pm 3^\circ\text{C}$ b. Relative Humidity: 45 to 75%RH c. Measuring equipment: HP 4338.	In accordance with electrical specification.
4	Appearance	Inductors shall be visually inspected for visible evidence of defect.	In accordance with specification.
5	Dimension	Dimension shall be measured with caliper or micrometer	In accordance with dimension specification.
6	Solderability	Immerse a test sample into a methanol solution containing resin and immerse into molten solder of $230 \pm 5^\circ\text{C}$ for $5 \pm 1$ second.	More than 75% of the terminal electrode part shall be covered with fresh solder.
7	Bending Strength	Solder the chip to test jig then apply a force in the direction shown in below. The soldering shall be done with the reflow method and shall be conducted with care so that the soldering is uniform and free of defects such as heat shock. <b>Mounting Samples</b> 	1. No mechanical damage shall be observed. 2. Rdc-value: to meet the initial Spec.
8	Resistance to Soldering Heat	Immerse a test sample into a methanol solution containing resin, preheat it at $120$ to $150^\circ\text{C}$ for 1 minute and immerse into molten solder of $270 \pm 5^\circ\text{C}$ for $10 \pm 1$ second so that both terminal electrodes are completely submerged.	No visible damage. Inductance variation within 10%. Q variation within 20%.
9	Thermal Shock	Solder a test sample to printed circuit board, and conduct 5 cycles of test under the conditions shown as below. 0201 & 0402 operating temp. range: $-55\sim 125^\circ\text{C}$ 0603 operating temp. range: $-40\sim 85^\circ\text{C}$ Cycle: Maximum operating temp. ( $30 \pm 3\text{min}$ )  Minimum operating temp. ( $30 \pm 3\text{min}$ )	No visible damage. Inductance variation within 10%. Q variation within 20%.
10	High Humidity State Life Test	Keep a test sample in an atmosphere with a temperature of $40 \pm 2^\circ\text{C}$ , 90~95%RH for $500 \pm 12$ hours. After the removal from test chamber, 2 to 3 hours of recovery under standard condition, and measurement shall be made after $24 \pm 2$ hrs. of recovery under standard condition.	No visible damage. Inductance variation within 10%. Q variation within 20%.
11	High Humidity Load Life Test	Solder a test sample to printed circuit board then keep the test sample in an atmosphere with a temperature of $40 \pm 2^\circ\text{C}$ , 90~95%RH for $500 \pm 12$ hours while supplying the rated current. After the removal from test chamber, 2 to 3 hours of recovery under standard condition, and measurement shall be made after $24 \pm 2$ hrs. of recovery under standard condition.	No visible damage. Inductance variation within 10%. Q variation within 20%.
12	High Temperature State Life Test	Keep a test sample in an atmosphere with a temperature of $85 \pm 2^\circ\text{C}$ for $500 \pm 12$ hours. After the removal from test chamber, 2 to 3 hours of recovery under standard condition, and measurement shall be made after $24 \pm 2$ hrs. of recovery under standard condition.	No visible damage. Inductance variation within 10%. Q variation within 20%.
13	High Temperature Load	Solder a test sample to printed circuit board then keep the test sample in an atmosphere with a temperature of $85 \pm 2^\circ\text{C}$ for $500 \pm 12$ hours while supplying the rated current. After the removal from test chamber, 2 to 3 hours of recovery under standard condition, and measurement shall be made after $24 \pm 2$ hrs. of recovery under standard condition.	No visible damage. Inductance variation within 10%. Q variation within 20%.



# Multi-Layer High Frequency Ceramic Chip Inductors



## LCMC Series

### PACKAGING SPECIFICATIONS

#### Paper tape specification (0201/0402/0603)

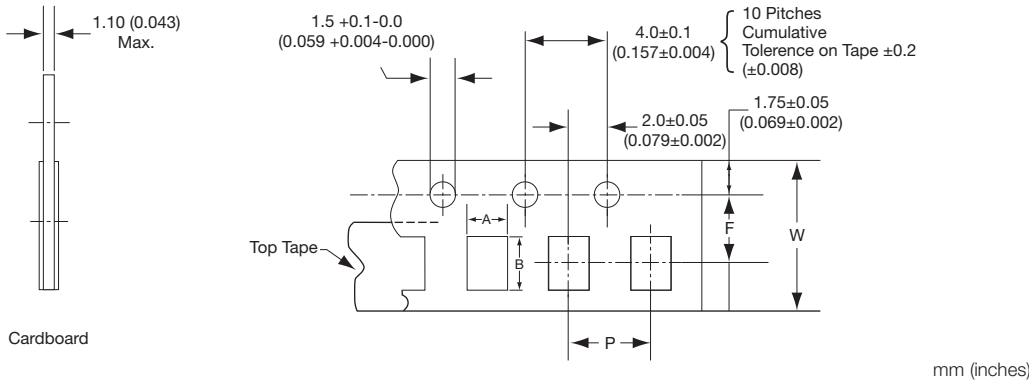

Symbol	Product Size Code					
	0201		0402		0603	
	Size	Tolerance	Size	Tolerance	Size	Tolerance
A	0.38 (0.015)	± 0.02 (0.001)	0.62 (0.024)	± 0.03 (0.001)	0.975 (0.038)	± 0.05 (0.002)
B	0.68 (0.027)	± 0.02 (0.001)	1.12 (0.044)	± 0.03 (0.001)	1.80 (0.071)	± 0.05 (0.002)
F	3.50 (0.138)	± 0.05 (0.002)	3.50 (0.138)	± 0.05 (0.002)	3.50 (0.138)	± 0.05 (0.002)
P	2.00 (0.079)	± 0.10 (0.004)	2.00 (0.079)	± 0.10 (0.004)	4.00 (0.157)	± 0.10 (0.004)
W	8.00 (0.315)	± 0.20 (0.008)	8.00 (0.315)	± 0.20 (0.008)	8.00 (0.315)	± 0.20 (0.008)

#### Reel Specifications

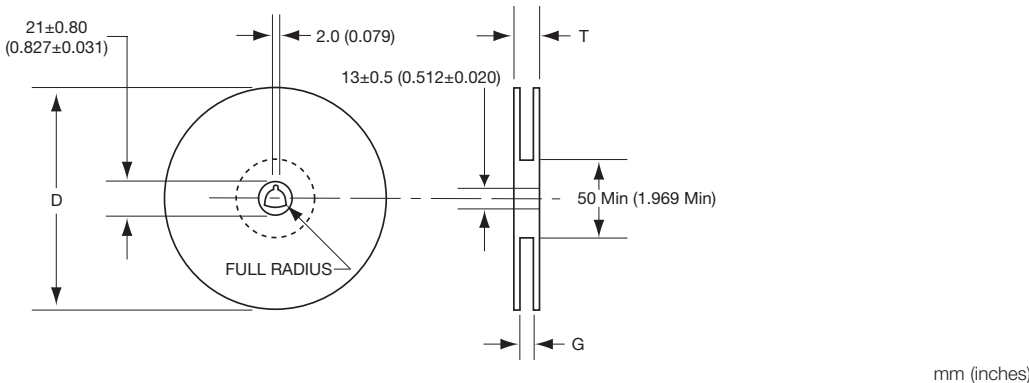

Tape Width	G	T max.	D
8.00 (0.315)	10.0 ± 1.5 (0.394 ± 0.059)	14.5 (0.571)	180 (7.087)

#### Peel strength of top cover tape

The peel speed shall be about 300 mm/min.

The peel strength of top cover tape shall be between 0.1 to 1.0N.

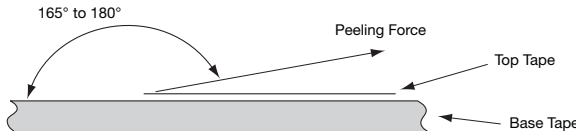

# Multi-Layer High Frequency Ceramic Chip Inductors

## LCMC Series

### Quantity per reel

0201: 15,000 pieces / reel  
 0402: 10,000 pieces / reel  
 0603: 4,000 pieces / reel

### The contents of a box

0201: 5 reels / box  
 0402: 5 reels / box  
 0603: 5 reels / box

### Marking

The following item shall be marked on the reel.

- Manufactures parts number.
- Manufacturing date code.
- Manufacturer name.
- Manufactures lot number.
- Quantity.

## CAUTIONS

### Storage

The chip inductor shall be packaged in carrier tapes.  
 To keep storage place temperature from +5 to 35°C, humidity from 45 to 70% RH.  
 The storage atmosphere must be free of gas containing sulfur and chlorine. Also, avoid exposing the product to saline moisture. If the product is exposed to such atmospheres, the terminals will oxidize and solderability will be affected.  
 The solderability is assured for 12 months from our final inspection date if the above storage condition is followed.

### Handling

Chip inductor should be handled with care to avoid contamination or damage. The use of vacuum pick-up or plastic tweezers is recommended for manual placement. Tape and reeled packages are suitable for automatic pick and placement machine.

### Recommended pad dimensions

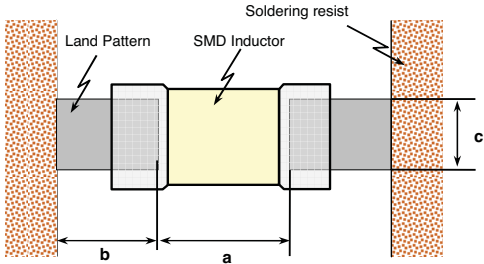

Size (EIA)	L x W	a	b	c
0201	0.60 x 0.30 (0.024 x 0.012)	0.15 to 0.35 (0.006 to 0.014)	0.20 to 0.30 (0.008 to 0.012)	0.25 to 0.30 (0.010 to 0.012)
0402	1.00 x 0.50 (0.039 x 0.020)	0.30 to 0.50 (0.012 to 0.020)	0.35 to 0.45 (0.014 to 0.018)	0.40 to 0.50 (0.016 to 0.020)
0603	1.60 x 0.80 (0.063 x 0.031)	0.70 to 1.00 (0.028 to 0.039)	0.60 to 0.80 (0.024 to 0.031)	0.70 to 0.80 (0.028 to 0.031)

### Soldering Profile for SMT Process with SnPb Solder Paste

The rate of preheat should not exceed 4°C/sec. and a target of 2°C/sec. is preferred. Ceramic chip components should be preheated to within 100 to 130°C of the soldering.

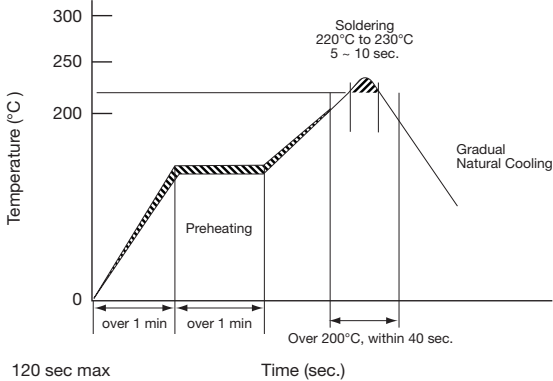

### Soldering Profile for SMT Process with Lead Free Solder Paste

The rate of preheat should not exceed 4°C/sec. and a target of 2°C/sec. is preferred. Ceramic chip components should be preheated to within 100 to 130°C of the soldering.

