

LM4665

LM4665 Filterless High Efficiency 1W Switching Audio Amplifier



Literature Number: SNAS146D

LM4665 Boomer® Audio Power Amplifier Series

Filterless High Efficiency 1W Switching Audio Amplifier

General Description

The LM4665 is a fully integrated single-supply high efficiency switching audio amplifier. It features an innovative modulator that eliminates the LC output filter used with typical switching amplifiers. Eliminating the output filter reduces parts count, simplifies circuit design, and reduces board area. The LM4665 processes analog inputs with a delta-sigma modulation technique that lowers output noise and THD when compared to conventional pulse width modulators.

The LM4665 is designed to meet the demands of mobile phones and other portable communication devices. Operating on a single 3V supply, it is capable of driving 8Ω transducer loads at a continuous average output of 400mW with less than 2%THD+N.

The LM4665 has high efficiency with an 8Ω transducer load compared to a typical Class AB amplifier. With a 3V supply, the IC's efficiency for a 100mW power level is 75%, reaching 80% at 400mW output power.

The LM4665 features a low-power consumption shutdown mode. Shutdown may be enabled by either a logic high or low depending on the mode selection. Connecting the Shutdown Mode pin to either V_{DD} (high) or GND (low) enables the Shutdown pin to be driven in a likewise manner to activate shutdown.

The LM4665 has fixed selectable gain of either 6dB or 12dB. The LM4665 has short circuit protection against a short from the outputs to V_{DD}, GND or across the outputs.

Key Specifications

- Efficiency at 100mW into 8Ω transducer 75%(typ)
- Efficiency at 400mW into 8Ω transducer 80%(typ)
- Total quiescent power supply current (3V) 3mA(typ)
- Total shutdown power supply current (3V) 0.01μA(typ)
- Single supply range (MSOP & LD) 2.7V to 5.5V
- Single supply range (ITL) (Note 11) 2.7V to 3.8V

Features

- No output filter required for inductive transducers
- Selectable gain of 6dB (2V/V) or 12dB (4V/V)
- Very fast turn on time: 5ms (typ)
- User selectable shutdown High or Low logic level
- Minimum external components
- "Click and pop" suppression circuitry
- Micro-power shutdown mode
- Short circuit protection
- micro SMD, LLP, and MSOP packages (no heat sink required)

Applications

- Mobile phones
- PDAs
- Portable electronic devices

Typical Application

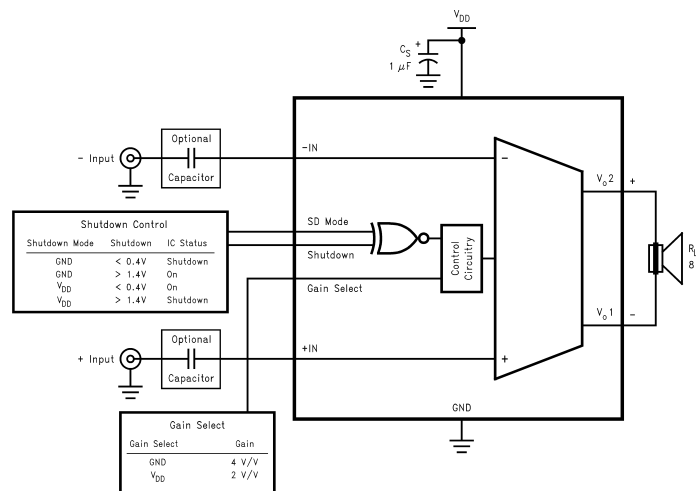

20027001

FIGURE 1. Typical Audio Amplifier Application Circuit

Boomer® is a registered trademark of National Semiconductor Corporation.

Connection Diagrams

Mini Small Outline (MSOP) Package

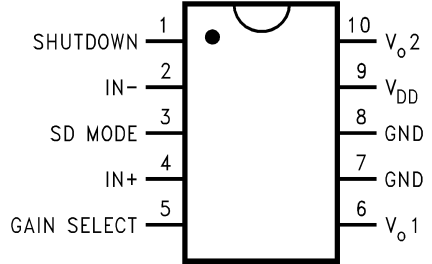

20027023

Top View
Order Number LM4665MM
See NS Package Number MUB10A

9 Bump micro SMD Package

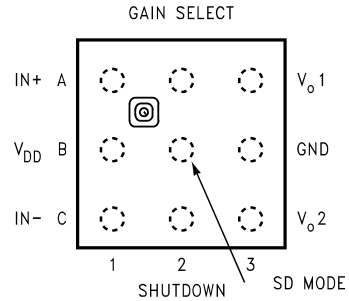

20027036

Top View
Order Number LM4665ITL, LM4665ITLX
See NS Package Number TLA09AAA

LLP Package

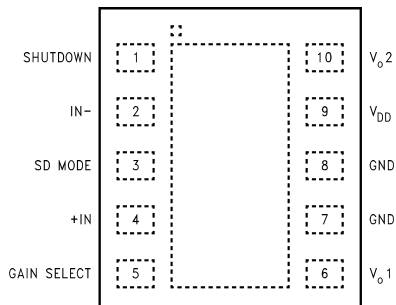

200270D0

Top View
Order Number LM4665LD
See NS Package Number LDA10B

micro SMD Marking

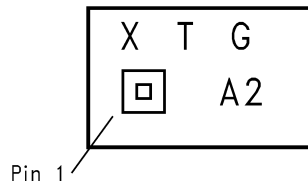

200270C6

Top View
X - Date Code
T- Die Traceability
G - Boomer Family
A2 - LM4665ITL

MSOP Marking

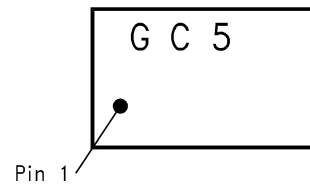

200270C5

Top View
G - Boomer Family
C5 - LM4665MM

LLP Marking

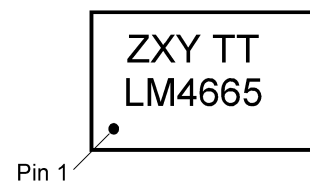

200270C9

Top View
Z - Plant Code
XY - Date Code
TT- Die Traceability
Bottom Line-Part Number

Absolute Maximum Ratings (Notes 1,

2)

If Military/Aerospace specified devices are required, please contact the National Semiconductor Sales Office/Distributors for availability and specifications.

Supply Voltage (Note 1)	6.0V
Storage Temperature	-65°C to +150°C
Voltage at Any Input Pin	$V_{DD} + 0.3V \geq V \geq GND - 0.3V$
Power Dissipation (Note 3)	Internally Limited
ESD Susceptibility (Note 4)	2.0kV
ESD Susceptibility (Note 5)	200V
Junction Temperature (T_J)	150°C
Thermal Resistance	
θ_{JA} (MSOP)	190°C/W

θ_{JC} (MSOP)	56°C/W
θ_{JA} (micro SMD)	180°C/W
θ_{JA} (LLP) (Note 10)	63°C/W
θ_{JC} (LLP) (Note 10)	12°C/W

Soldering Information

See AN-1112 "microSMD Wafers Level Chip Scale Package."

Operating Ratings (Note 2)**Temperature Range**

$$T_{MIN} \leq T_A \leq T_{MAX} \quad -40^\circ\text{C} \leq T_A \leq 85^\circ\text{C}$$

$$\text{Supply Voltage (MSOP \& LD)} \quad 2.7V \leq V_{DD} \leq 5.5V$$

$$\text{Supply Voltage (ITL) (Note 11)} \quad 2.7V \leq V_{DD} \leq 3.8V$$

Electrical Characteristics $V_{DD} = 5V$ (Notes 1, 2, 11)

The following specifications apply for $V_{DD} = 5V$, $R_L = 8\Omega + 33\mu H$, measurement bandwidth is <10Hz - 22kHz unless otherwise specified. Limits apply for $T_A = 25^\circ\text{C}$.

Symbol	Parameter	Conditions	LM4665		Units (Limits)
			Typical	Limit	
			(Note 6)	(Notes 7, 8)	
I_{DD}	Quiescent Power Supply Current	$V_{IN} = 0V$, No Load	14		mA
		$V_{IN} = 0V$, $8\Omega + 22\mu H$ Load	14.5		mA
I_{SD}	Shutdown Current	$V_{SD} = V_{SD Mode}$ (Note 9)	0.1	5.0	μA (max)
V_{SDIH}	Shutdown Voltage Input High	$V_{SD Mode} = V_{DD}$	1.2	1.4	V (min)
V_{SDIL}	Shutdown Voltage Input Low	$V_{SD Mode} = V_{DD}$	1.1	0.4	V (max)
V_{SDIH}	Shutdown Voltage Input High	$V_{SD Mode} = GND$	1.2	1.4	V (min)
V_{SDIL}	Shutdown Voltage Input Low	$V_{SD Mode} = GND$	1.1	0.4	V (max)
V_{GSIH}	Gain Select Input High		1.2	1.4	V (min)
V_{GSIL}	Gain Select Input Low		1.1	0.4	V (max)
A_V	Closed Loop Gain	$V_{Gain Select} = V_{DD}$	6	5.5 6.5	dB (min) dB (max)
		$V_{Gain Select} = GND$	12	11.5 12.5	dB (min) dB (max)
V_{OS}	Output Offset Voltage		10		mV
T_{WU}	Wake-up Time		5		ms
P_o	Output Power	THD+N = 3% (max), $f_{IN} = 1\text{kHz}$	1.4		W
THD+N	Total Harmonic Distortion+Noise	$P_O = 400\text{mW}_{RMS}$, $f_{IN} = 1\text{kHz}$	0.8		%
R_{IN}	Differential Input Resistance	$V_{Gain Select} = V_{DD}$, Gain = 6dB	100		k Ω
		$V_{Gain Select} = GND$, Gain = 12dB	65		k Ω
PSRR	Power Supply Rejection Ratio	$V_{Ripple} = 100\text{mV}_{RMS}$, $f_{Ripple} = 217\text{Hz}$, $A_V = 6\text{dB}$ Inputs Terminated	52		dB
CMRR	Common Mode Rejection Ratio	$V_{Ripple} = 100\text{mV}_{RMS}$, $f_{Ripple} = 217\text{Hz}$, $A_V = 6\text{dB}$	43		dB
e_N	Output Noise Voltage	A-Weighted filter, $V_{IN} = 0V$	350		μV

Electrical Characteristics $V_{DD} = 3V$ (Notes 1, 2)

The following specifications apply for $V_{DD} = 3V$, and $R_L = 8\Omega + 33\mu H$, measurement bandwidth is $<10Hz - 22kHz$ unless otherwise specified. Limits apply for $T_A = 25^\circ C$.

Symbol	Parameter	Conditions	LM4665		Units (Limits)
			Typical	Limit	
			(Note 6)	(Notes 7, 8)	
I_{DD}	Quiescent Power Supply Current	$V_{IN} = 0V$, No Load $V_{IN} = 0V$, $8\Omega + 22\mu H$ Load	3.0 3.5	7.0	mA (max) mA
I_{SD}	Shutdown Current	$V_{SD} = V_{SD Mode}$ (Note 9)	0.01	5.0	μA (max)
V_{SDIH}	Shutdown Voltage Input High	$V_{SD Mode} = V_{DD}$	1.0	1.4	V (min)
V_{SDIL}	Shutdown Voltage Input Low	$V_{SD Mode} = V_{DD}$	0.8	0.4	V (max)
V_{SDIH}	Shutdown Voltage Input High	$V_{SD Mode} = GND$	1.0	1.4	V (min)
V_{SDIL}	Shutdown Voltage Input Low	$V_{SD Mode} = GND$	0.8	0.4	V (max)
V_{GSIH}	Gain Select Input High		1.0	1.4	V (min)
V_{GSIL}	Gain Select Input Low		0.8	0.4	V (max)
A_V	Closed Loop Gain	$V_{Gain Select} = V_{DD}$	6	5.5 6.5	dB (min) dB (max)
A_V	Closed Loop Gain	$V_{Gain Select} = GND$	12	11.5 12.5	dB (min) dB (max)
V_{OS}	Output Offset Voltage		10		mV
T_{WU}	Wake-up Time		5		ms
P_o	Output Power	THD+N = 2% (max), $f_{IN} = 1kHz$	400	350	mW (min)
THD+N	Total Harmonic Distortion+Noise	$P_o = 100mW_{RMS}$, $f_{IN} = 1kHz$	0.4		% (max)
R_{IN}	Differential Input Resistance	$V_{Gain Select} = V_{DD}$, Gain = 6dB	100		$k\Omega$
		$V_{Gain Select} = GND$, Gain = 12dB	65		$k\Omega$
PSRR	Power Supply Rejection Ratio	$V_{Ripple} = 100mV_{RMS}$, $f_{Ripple} = 217Hz$, $A_V = 6dB$, Inputs Terminated	52		dB
CMRR	Common Mode Rejection Ratio	$V_{Ripple} = 100mV_{RMS}$, $f_{Ripple} = 217Hz$, $A_V = 6dB$	39		dB
e_N	Output Noise Voltage	A-Weighted filter, $V_{IN} = 0V$	350		μV

Note 1: All voltages are measured with respect to the ground pin, unless otherwise specified.

Note 2: *Absolute Maximum Ratings* indicate limits beyond which damage to the device may occur. *Operating Ratings* indicate conditions for which the device is functional, but do not guarantee specific performance limits. *Electrical Characteristics* state DC and AC electrical specifications under particular test conditions which guarantee specific performance limits. This assumes that the device is within the Operating Ratings. Specifications are not guaranteed for parameters where no limit is given, however, the typical value is a good indication of device performance.

Note 3: The maximum power dissipation must be derated at elevated temperatures and is dictated by T_{JMAX} , θ_{JA} , and the ambient temperature T_A . The maximum allowable power dissipation is $P_{DMAX} = (T_{JMAX} - T_A) / \theta_{JA}$ or the number given in Absolute Maximum Ratings, whichever is lower. For the LM4665, $T_{JMAX} = 150^\circ C$. See the **Efficiency and Power Dissipation versus Output Power** curves for more information.

Note 4: Human body model, 100 pF discharged through a 1.5 k Ω resistor.

Note 5: Machine Model, 220 pF–240 pF discharged through all pins.

Note 6: Typical specifications are specified at 25 $^\circ C$ and represent the parametric norm.

Note 7: Tested limits are guaranteed to National's AOQL (Average Outgoing Quality Level).

Note 8: Datasheet min/max specification limits are guaranteed by design, test, or statistical analysis.

Note 9: Shutdown current is measured in a normal room environment. Exposure to direct sunlight will increase I_{SD} by a maximum of 2 μA . The Shutdown Mode pin should be connected to V_{DD} or GND and the Shutdown pin should be driven as close as possible to V_{DD} or GND for minimum shutdown current and the best THD performance in PLAY mode. See the **Application Information** section under SHUTDOWN FUNCTION for more information.

Note 10: The exposed-DAP of the LDA10B package should be electrically connected to GND.

Note 11: The LM4665 in the micro SMD package (ITL) has an operating range of 2.7V - 3.8V for 8 Ω speaker loads. The supply range may be increased as speaker impedance is increased. It is not recommended that 4 Ω loads be used with the micro SMD package. To increase the supply voltage operating range, see Figure 2 and INCREASING SUPPLY VOLTAGE RANGE in the **Application Information** section for more information.

External Components Description

(Figure 1)

Components	Functional Description
1. C_S	Supply bypass capacitor which provides power supply filtering. Refer to the Power Supply Bypassing section for information concerning proper placement and selection of the supply bypass capacitor.

Typical Performance Characteristics

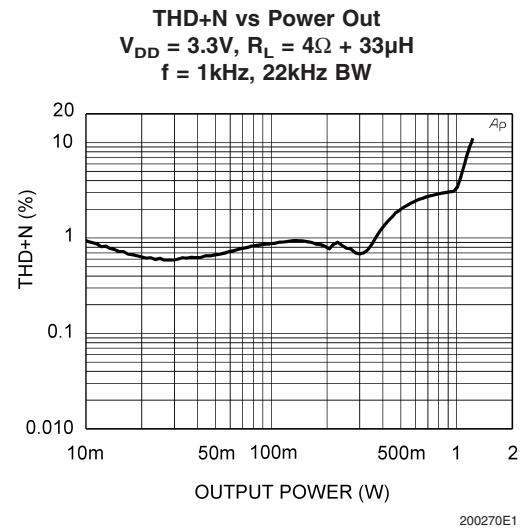
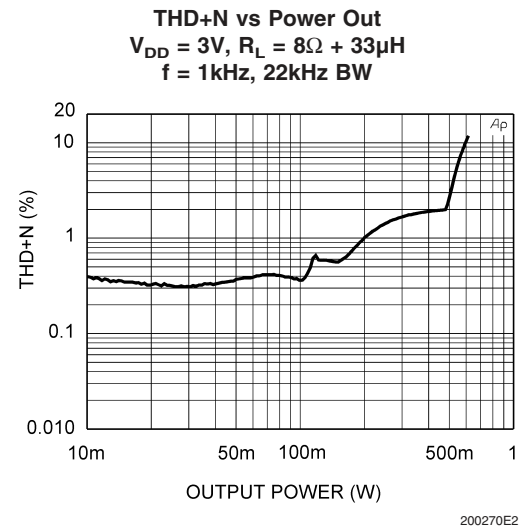
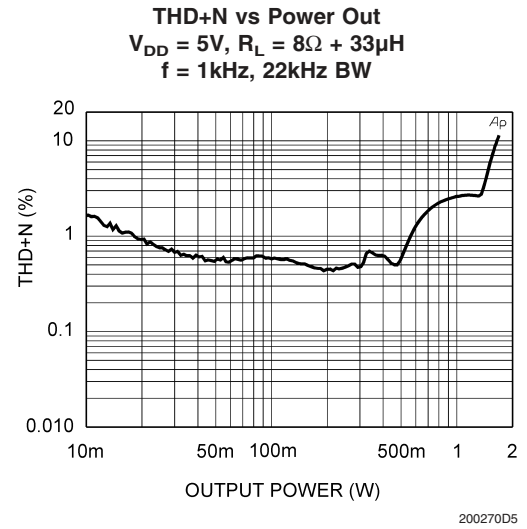
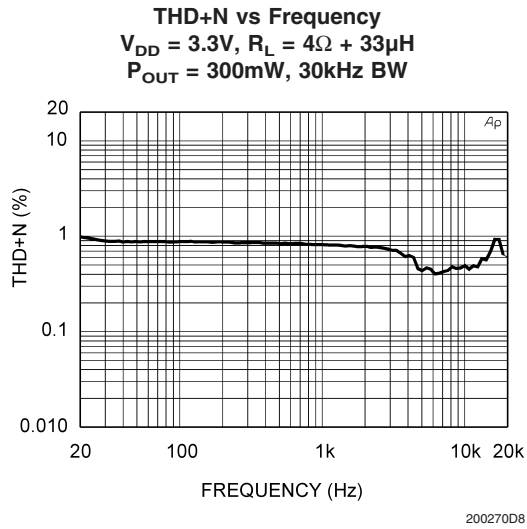
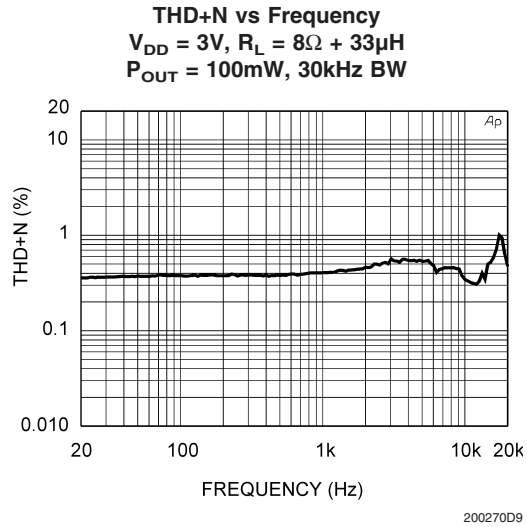
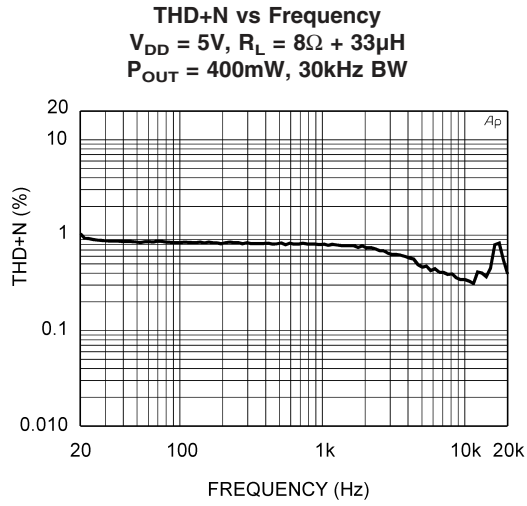

Typical Performance Characteristics (Continued)

THD+N vs Common-Mode Voltage
 $V_{DD} = 5V, R_L = 8\Omega + 33\mu H, f = 1kHz$
 $P_{OUT} = 400mW, 22kHz BW$

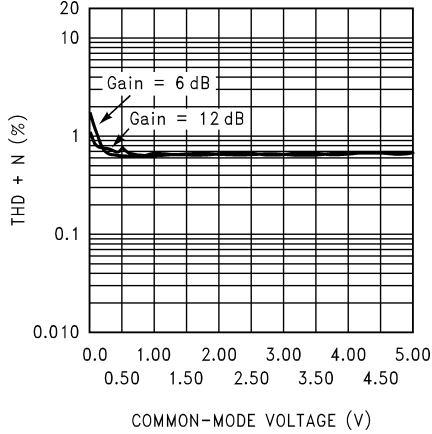

20027032

THD+N vs Common-Mode Voltage
 $V_{DD} = 3V, R_L = 8\Omega + 33\mu H, f = 1kHz$
 $P_{OUT} = 100mW, 22kHz BW$

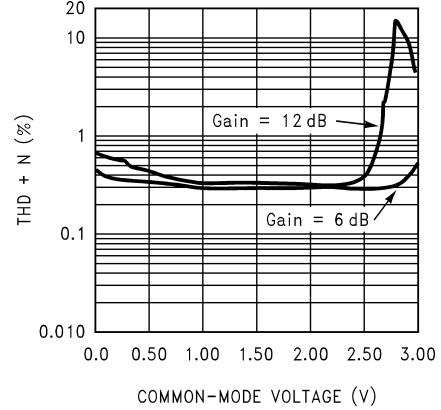

20027031

CMRR vs Frequency
 $V_{DD} = 5V, R_L = 8\Omega + 33\mu H$
 $V_{CM} = 100mV_{RMS}$ Sine Wave, 80kHz BW

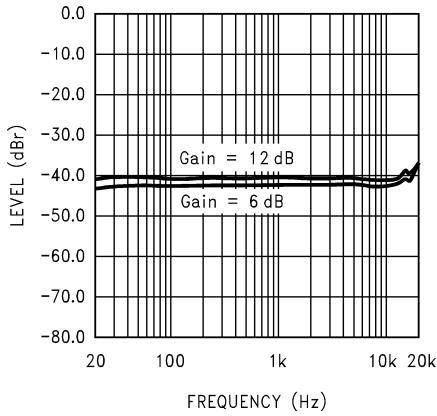

20027095

CMRR vs Frequency
 $V_{DD} = 3V, R_L = 8\Omega + 33\mu H$
 $V_{CM} = 100mV_{RMS}$ Sine Wave, 80kHz BW

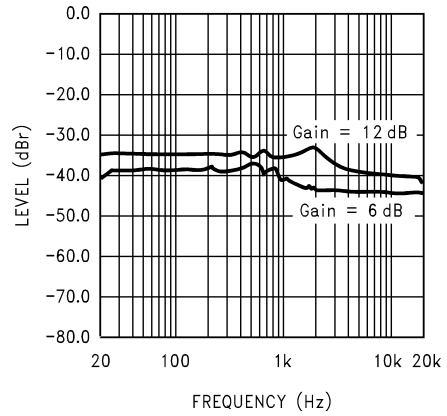

20027098

PSRR vs DC Common-Mode Voltage
 $V_{DD} = 5V, R_L = 8\Omega + 33\mu H$
 $V_{Ripple} = 100mV_{RMS}, f_{Ripple} = 217Hz$ Sine Wave

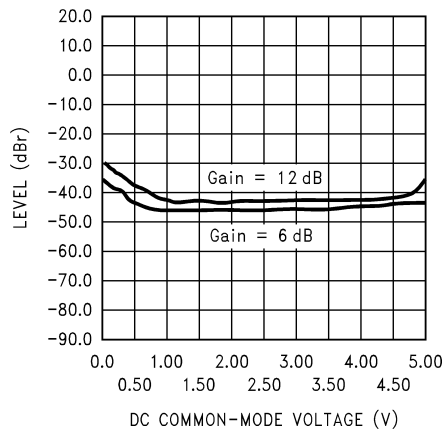

20027097

PSRR vs DC Common-Mode Voltage
 $V_{DD} = 3V, R_L = 8\Omega + 33\mu H$
 $V_{Ripple} = 100mV_{RMS}, f_{Ripple} = 217Hz$ Sine Wave

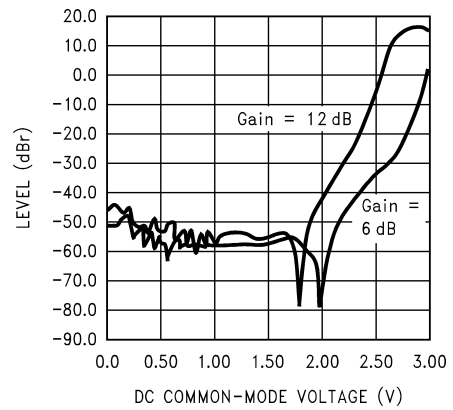

20027096

Typical Performance Characteristics (Continued)

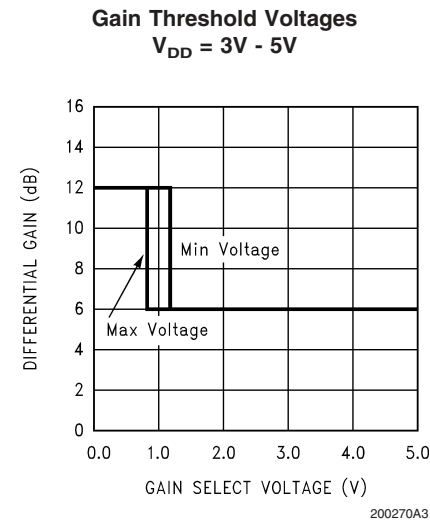
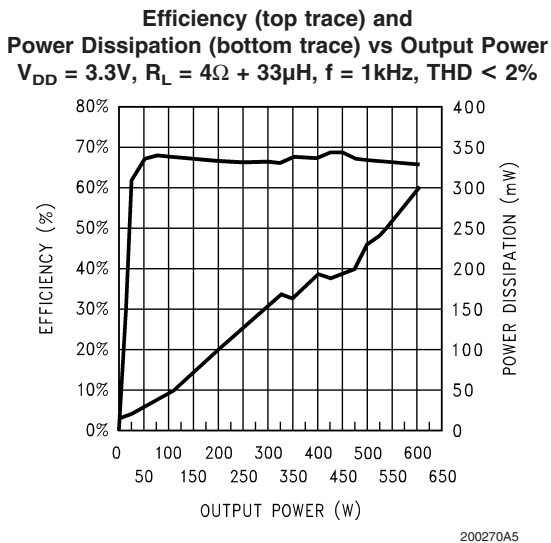
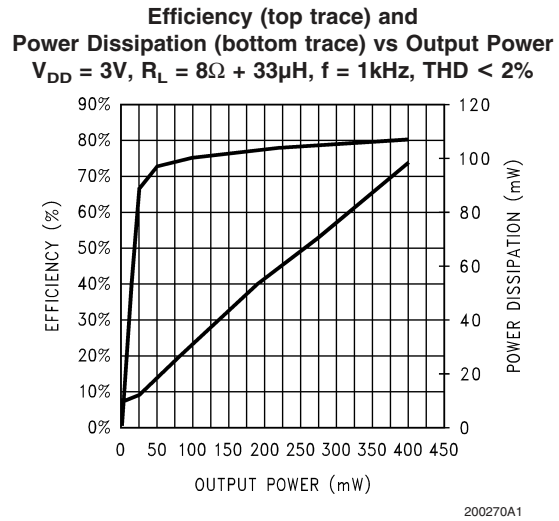
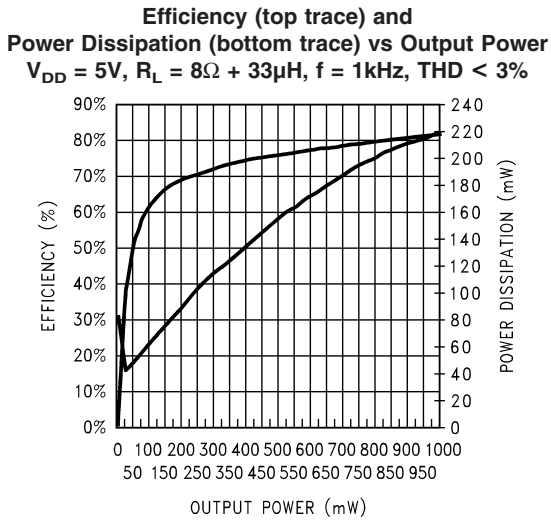
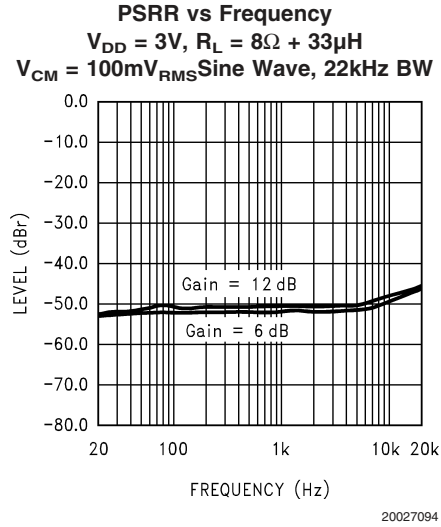
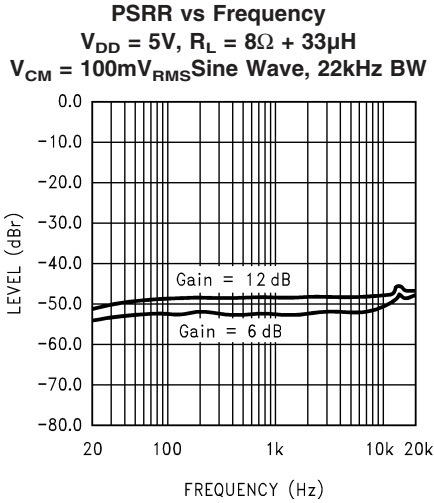

Typical Performance Characteristics (Continued)

Output Power vs Supply Voltage
 $R_L = 16\Omega + 33\mu H, f = 1kHz$

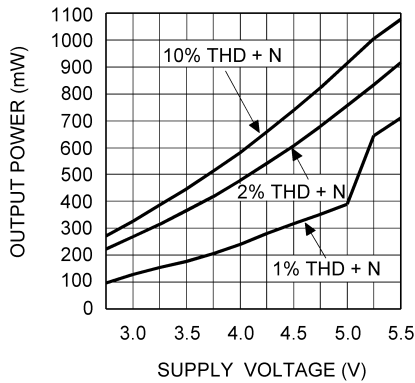

200270E3

Output Power vs Supply Voltage
 $R_L = 8\Omega + 33\mu H, f = 1kHz$

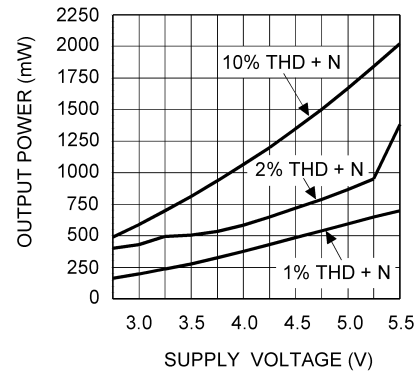

200270D7

Output Power vs Supply Voltage
 $R_L = 4\Omega + 33\mu H, f = 1kHz$

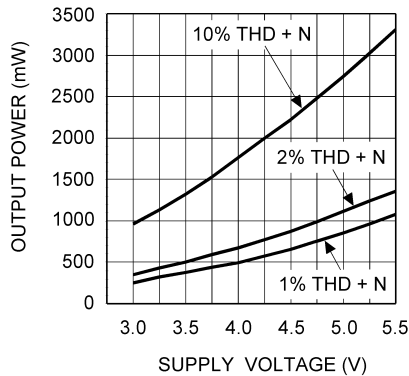

200270D6

Shutdown Hysteresis Voltage
 $V_{DD} = 5V, SD Mode = GND (SD Low)$

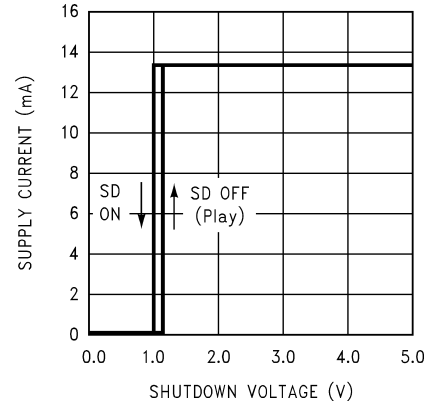

200270A7

Shutdown Hysteresis Voltage
 $V_{DD} = 3V, SD Mode = GND (SD Low)$

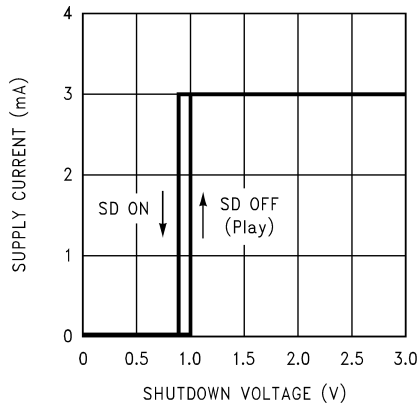

200270A8

Shutdown Hysteresis Voltage
 $V_{DD} = 5V, SD Mode = GND (SD High)$

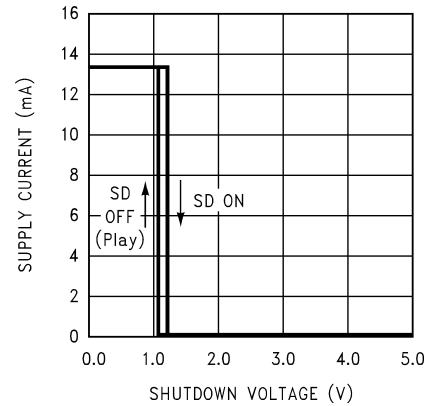

200270A9

Typical Performance Characteristics (Continued)

Shutdown Hysteresis Voltage
 $V_{DD} = 3V$, SD Mode = GND (SD High)

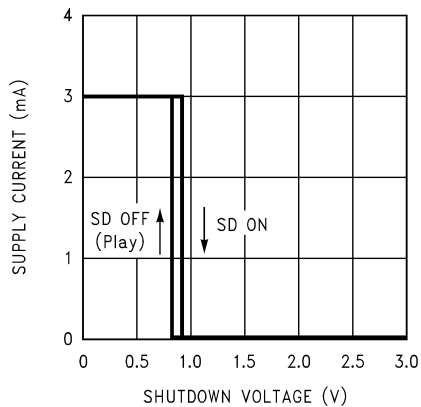

200270B0

Supply Current vs Supply Voltage
 $R_L = 8\Omega + 33\mu H$

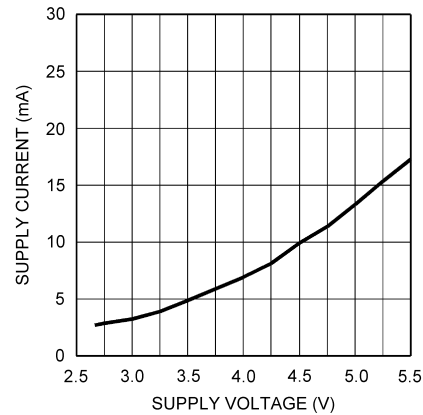

20027002

Application Information

GENERAL AMPLIFIER FUNCTION

The output signals generated by the LM4665 consist of two, BTL connected, output signals that pulse momentarily from near ground potential to V_{DD} . The two outputs can pulse independently with the exception that they both may never pulse simultaneously as this would result in zero volts across the BTL load. The minimum width of each pulse is approximately 160ns. However, pulses on the same output can occur sequentially, in which case they are concatenated and appear as a single wider pulse to achieve an effective 100% duty cycle. This results in maximum audio output power for a given supply voltage and load impedance. The LM4665 can achieve much higher efficiencies than class AB amplifiers while maintaining acceptable THD performance.

The short (160ns) drive pulses emitted at the LM4665 outputs means that good efficiency can be obtained with minimal load inductance. The typical transducer load on an audio amplifier is quite reactive (inductive). For this reason, the load can act as its own filter, so to speak. This "filter-less" switching amplifier/transducer load combination is much more attractive economically due to savings in board space and external component cost by eliminating the need for a filter.

POWER DISSIPATION AND EFFICIENCY

In general terms, efficiency is considered to be the ratio of useful work output divided by the total energy required to produce it with the difference being the power dissipated, typically, in the IC. The key here is "useful" work. For audio systems, the energy delivered in the audible bands is considered useful including the distortion products of the input signal. Sub-sonic (DC) and super-sonic components (>22kHz) are not useful. The difference between the power flowing from the power supply and the audio band power being transduced is dissipated in the LM4665 and in the transducer load. The amount of power dissipation in the LM4665 is very low. This is because the ON resistance of the switches used to form the output waveforms is typically less than 0.25Ω . This leaves only the transducer load as a po-

tential "sink" for the small excess of input power over audio band output power. The LM4665 dissipates only a fraction of the excess power requiring no additional PCB area or copper plane to act as a heat sink.

DIFFERENTIAL AMPLIFIER EXPLANATION

As logic supply voltages continue to shrink, designers are increasingly turning to differential analog signal handling to preserve signal to noise ratios with restricted voltage swing. The LM4665 is a fully differential amplifier that features differential input and output stages. A differential amplifier amplifies the difference between the two input signals. Traditional audio power amplifiers have typically offered only single-ended inputs resulting in a 6dB reduction in signal to noise ratio relative to differential inputs. The LM4665 also offers the possibility of DC input coupling which eliminates the two external AC coupling, DC blocking capacitors. The LM4665 can be used, however, as a single ended input amplifier while still retaining its fully differential benefits. In fact, completely unrelated signals may be placed on the input pins. The LM4665 simply amplifies the difference between the signals. A major benefit of a differential amplifier is the improved common mode rejection ratio (CMRR) over single input amplifiers. The common-mode rejection characteristic of the differential amplifier reduces sensitivity to ground offset related noise injection, especially important in high noise applications.

PCB LAYOUT CONSIDERATIONS

As output power increases, interconnect resistance (PCB traces and wires) between the amplifier, load and power supply create a voltage drop. The voltage loss on the traces between the LM4665 and the load results in lower output power and decreased efficiency. Higher trace resistance between the supply and the LM4665 has the same effect as a poorly regulated supply, increase ripple on the supply line also reducing the peak output power. The effects of residual trace resistance increases as output current increases due to higher output power, decreased load impedance or both. To maintain the highest output voltage swing and corresponding peak output power, the PCB traces that connect

Application Information (Continued)

the output pins to the load and the supply pins to the power supply should be as wide as possible to minimize trace resistance.

The rising and falling edges are necessarily short in relation to the minimum pulse width (160ns), having approximately 2ns rise and fall times, typical, depending on parasitic output capacitance. The inductive nature of the transducer load can also result in overshoot on one or both edges, clamped by the parasitic diodes to GND and V_{DD} in each case. From an EMI standpoint, this is an aggressive waveform that can radiate or conduct to other components in the system and cause interference. It is essential to keep the power and output traces short and well shielded if possible. Use of ground planes, beads, and micro-strip layout techniques are all useful in preventing unwanted interference.

POWER SUPPLY BYPASSING

As with any power amplifier, proper supply bypassing is critical for low noise performance and high power supply rejection ratio (PSRR). The capacitor (C_S) location should be as close as possible to the LM4665. Typical applications employ a voltage regulator with a 10 μ F and a 0.1 μ F bypass capacitors that increase supply stability. These capacitors do not eliminate the need for bypassing on the supply pin of the LM4665. A 1 μ F tantalum capacitor is recommended.

SHUTDOWN FUNCTION

In order to reduce power consumption while not in use, the LM4665 contains shutdown circuitry that reduces current draw to less than 0.01 μ A. In addition, the LM4665 contains a Shutdown Mode pin allowing the designer to designate whether the shutdown circuitry is activated by either a High level logic signal or a Low level logic signal. The Shutdown Mode pin should be permanently connected to either GND (Low) or V_{DD} (High). The LM4665 may then be placed into shutdown by toggling the Shutdown pin to the same state as the Shutdown Mode pin. For simplicity's sake, this is called "Shutdown same", as the LM4665 enters into a shutdown state whenever the two pins are in the same logic state. The trigger point for either shutdown high or shutdown low is shown as a typical value in the Electrical Characteristics Tables and in the Shutdown Hysteresis Voltage graphs found in the **Typical Performance Characteristics** section. It is best to switch between ground and supply for minimum current usage while in the shutdown state. While the LM4665 may be disabled with shutdown voltages in between ground and supply, the idle current will be greater than the typical 0.01 μ A value. Increased THD may also be observed with voltages greater than GND and less than V_{DD} on the Shutdown pin when in PLAY mode.

The LM4665 has an internal resistor connected between the Shutdown Mode and Shutdown pins. The purpose of this resistor is to eliminate any unwanted state changes when the Shutdown pin is floating, as long as the Shutdown Mode pin is connected to GND or V_{DD} . When the Shutdown Mode pin is properly connected, the LM4665 will enter the shutdown state when the Shutdown pin is left floating or if not floating, when the shutdown voltage has crossed the corresponding threshold for the logic level assigned by the Shutdown Mode pin voltage. To minimize the supply current while in the shutdown state, the Shutdown pin should be driven to the same potential as the Shutdown Mode pin or left floating. The amount of additional current due to the internal shutdown resistor can be found by Equation (1) below.

$$(V_{SD\ MODE} - V_{SD}) / 60k\Omega \quad (1)$$

With only a 0.5V difference between the Shutdown Mode voltage and the Shutdown voltage an additional 8.3 μ A of current will be drawn while in the shutdown state.

GAIN SELECTION FUNCTION

The LM4665 has fixed selectable gain to minimize external components, increase flexibility and simplify design. For a differential gain of 6dB (2V/V), the Gain Select pin should be permanently connected to V_{DD} or driven to a logic high level. For a differential gain of 12dB (4V/V), the Gain Select pin should be permanently connected to GND or driven to a logic low level. The gain of the LM4665 can be switched while the amplifier is in PLAY mode driving a load with a signal without damage to the IC. The voltage on the Gain Select pin should be switched quickly between GND (logic low) and V_{DD} (logic high) to eliminate any possible audible artifacts from appearing at the output. For typical threshold voltages for the Gain Select function, refer to the Gain Threshold Voltages graph in the **Typical Performance Characteristics** section.

INCREASING SUPPLY VOLTAGE RANGE

When using the micro SMD package (ITL), the operating supply voltage range is 2.7V - 3.8V with an 8 Ω speaker load. To increase the operating supply voltage range, four Schottky diodes (D_1 - D_4) can be used to control the over and undershoot of the output pulse waveform (See Figure 2 below). To reduce THD+N, small value capacitors in the range of 10pF - 33pF (C_{N1} & C_{N2}) can also be added as needed. The diodes should be placed as close to the micro SMD package as possible.

Application Information (Continued)

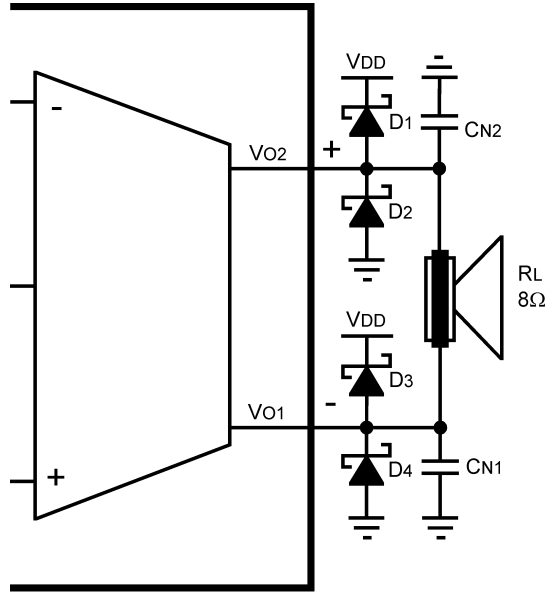

200270E5

FIGURE 2. Increased Supply Voltage Operating Range for the micro SMD package

SINGLE-ENDED CIRCUIT CONFIGURATIONS

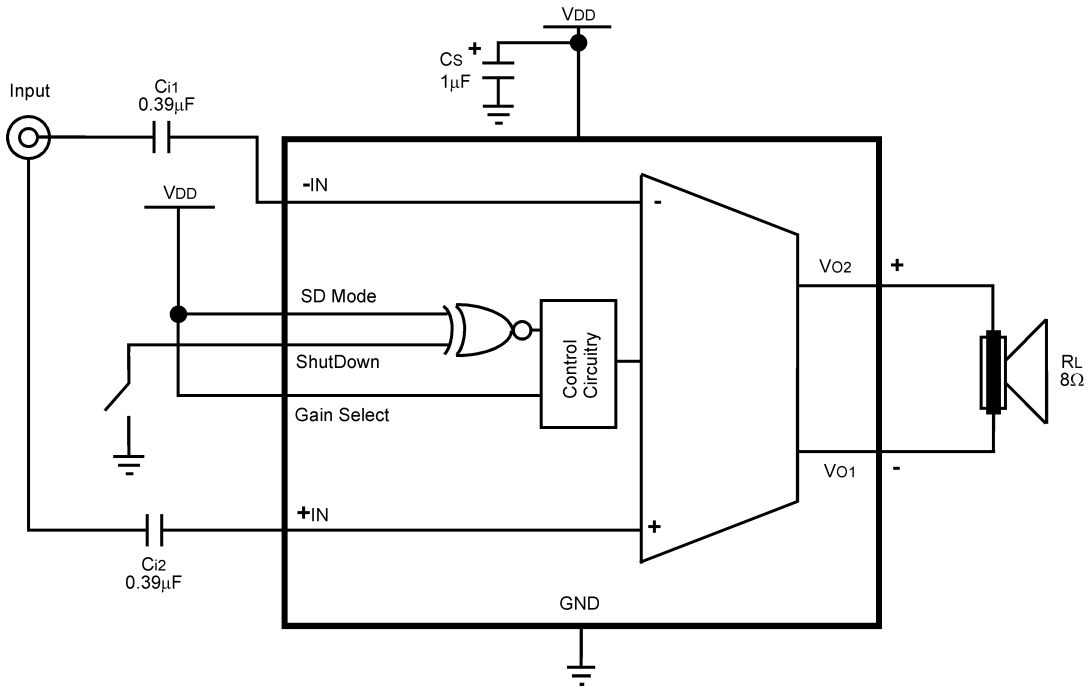

200270C4

FIGURE 3. Single-Ended Input, Shutdown High and Gain of 6dB Configuration

Application Information (Continued)

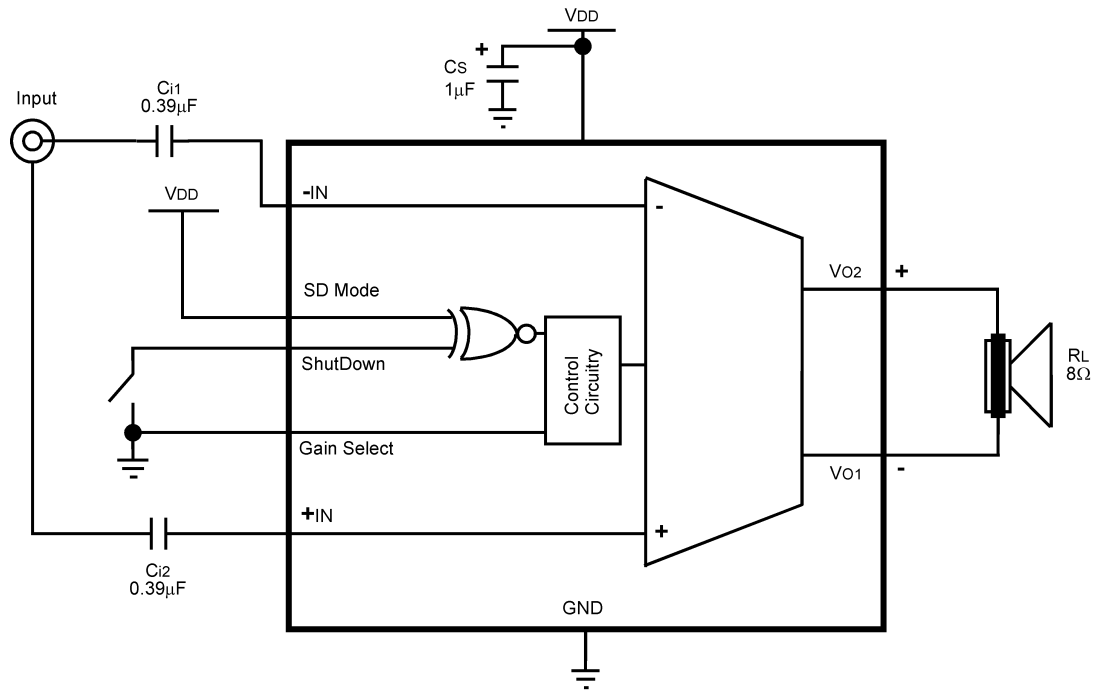

200270C2

FIGURE 4. Single-Ended Input, Shutdown High and Gain of 12dB Configuration

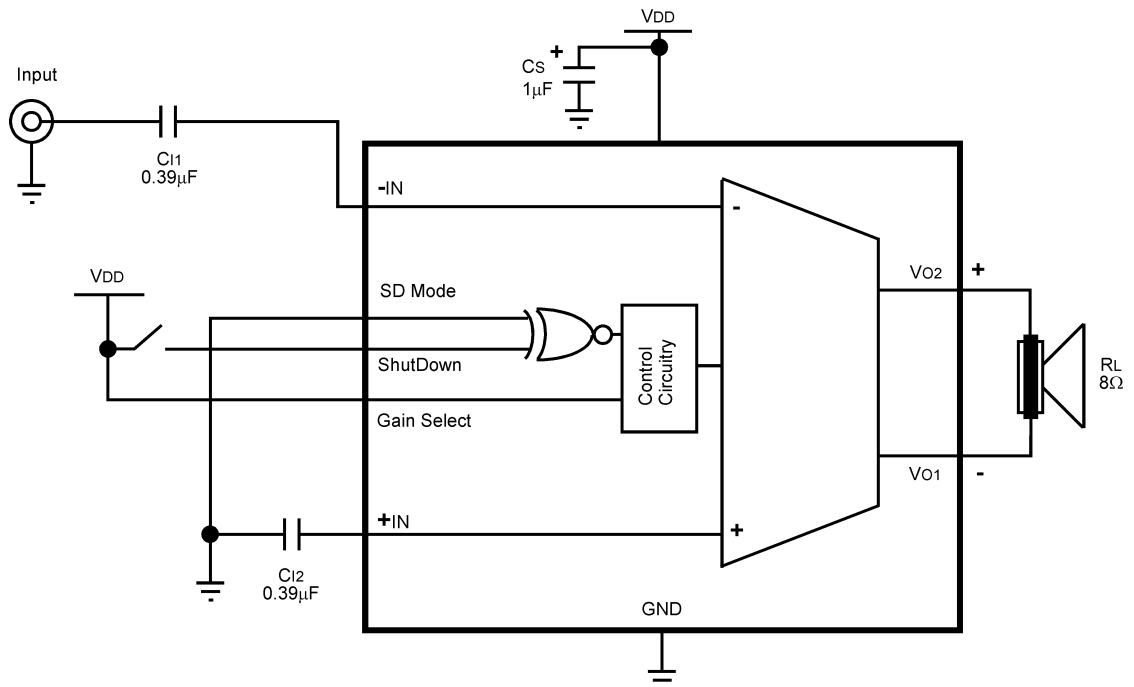

200270C3

FIGURE 5. Single-Ended Input, Shutdown Low and Gain of 6dB Configuration

Application Information (Continued)

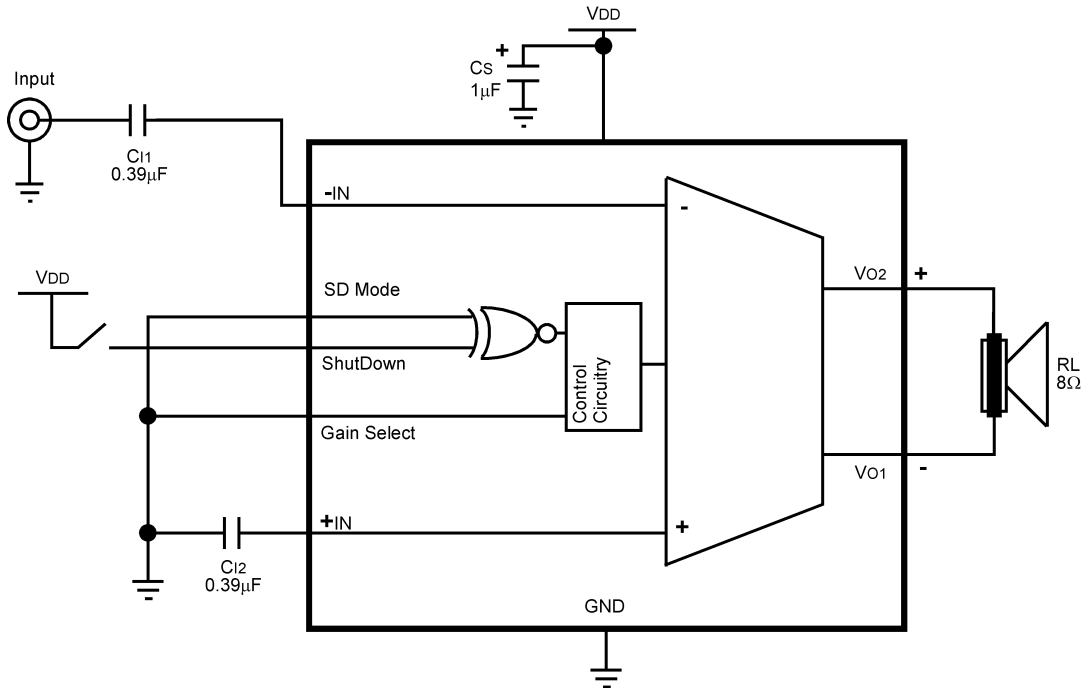

200270C1

FIGURE 6. Single-Ended Input, Shutdown Low and Gain of 12dB Configuration

REFERENCE DESIGN BOARD SCHEMATIC

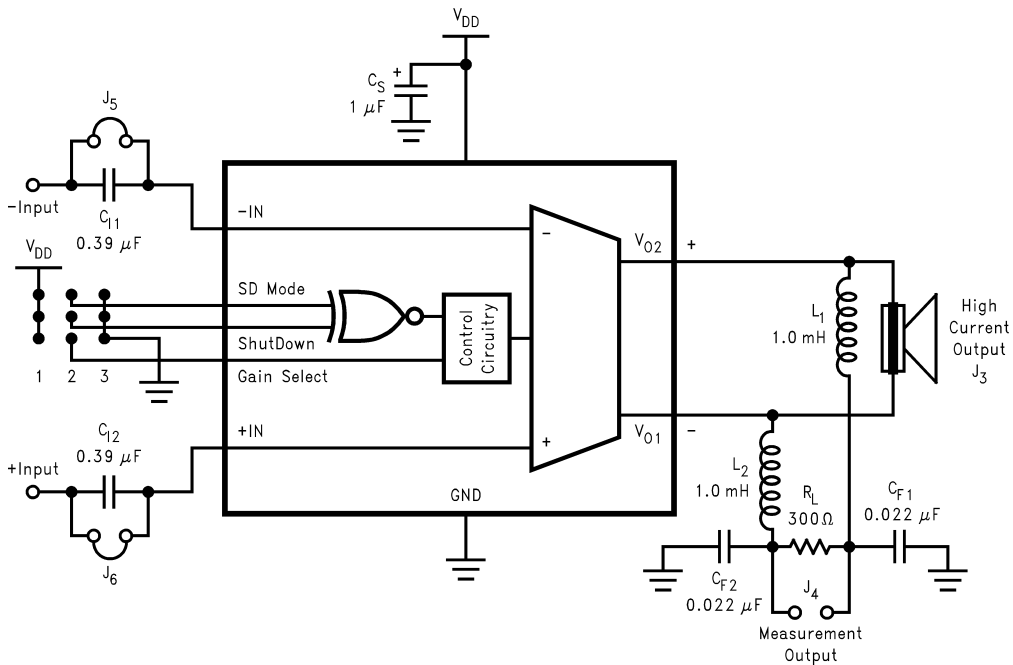

200270B1

FIGURE 7.

Application Information (Continued)

In addition to the minimal parts required for the application circuit, a measurement filter is provided on the evaluation circuit board so that conventional audio measurements can be conveniently made without additional equipment. This is a balanced input / grounded differential output low pass filter with a 3dB frequency of approximately 35kHz and an on board termination resistor of 300Ω (see schematic). Note that the capacitive load elements are returned to ground. This is not optimal for common mode rejection purposes, but due to the independent pulse format at each output there is a significant amount of high frequency common mode component on the outputs. The grounded capacitive filter elements attenuate this component at the board to reduce the high frequency CMRR requirement placed on the analysis instruments.

Even with the grounded filter the audio signal is still differential, necessitating a differential input on any analysis instrument connected to it. Most lab instruments that feature BNC connectors on their inputs are **NOT** differential responding because the ring of the BNC is usually grounded.

The commonly used Audio Precision analyzer is differential, but its ability to accurately reject fast pulses of 160nS width is questionable necessitating the on board measurement filter. When in doubt or when the signal needs to be single-ended, use an audio signal transformer to convert the differential output to a single ended output. Depending on the audio transformer's characteristics, there may be some attenuation of the audio signal which needs to be taken into account for correct measurement of performance.

Measurements made at the output of the measurement filter suffer attenuation relative to the primary, unfiltered outputs even at audio frequencies. This is due to the resistance of the inductors interacting with the termination resistor (300Ω) and is typically about -0.35dB (4%). In other words, the voltage levels (and corresponding power levels) indicated through the measurement filter are slightly lower than those that actually occur at the load placed on the unfiltered outputs. This small loss in the filter for measurement gives a lower output power reading than what is really occurring on the unfiltered outputs and its load.

LM4665 MSOP BOARD ARTWORK

Composite View

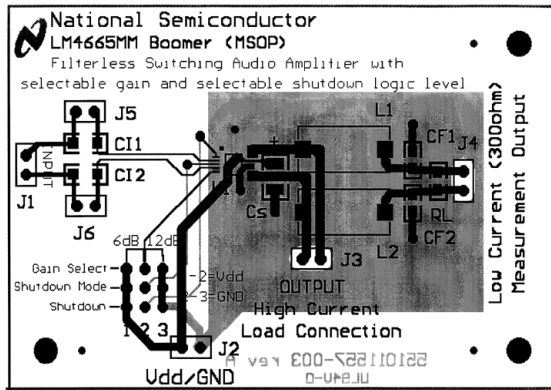

200270B2

Silk Screen

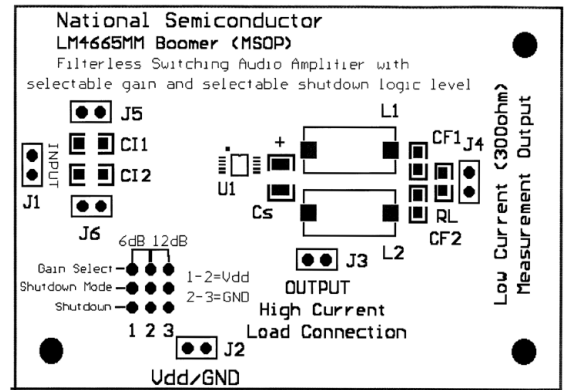

200270B3

Top Layer

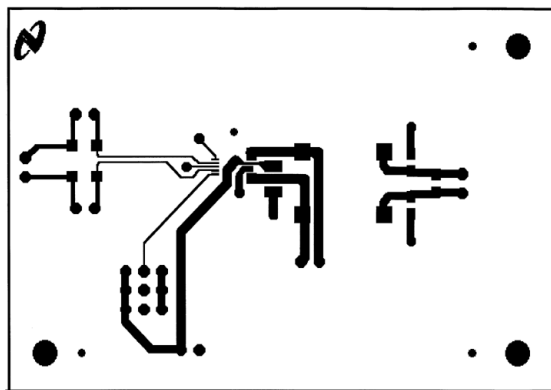

200270B4

Bottom Layer

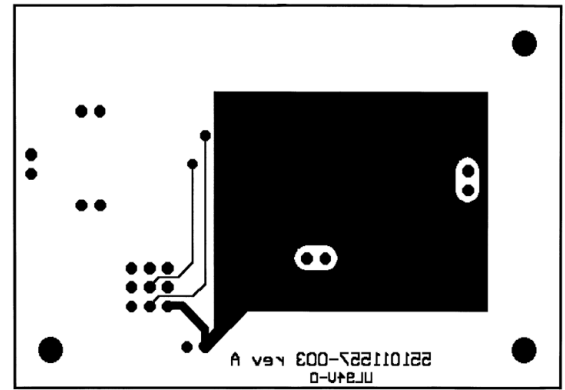

200270B5

Application Information (Continued)

LM4665 LLP BOARD ARTWORK

Composite View

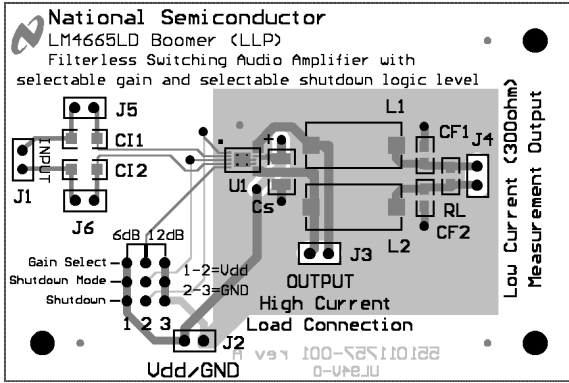

200270D1

Silk Screen

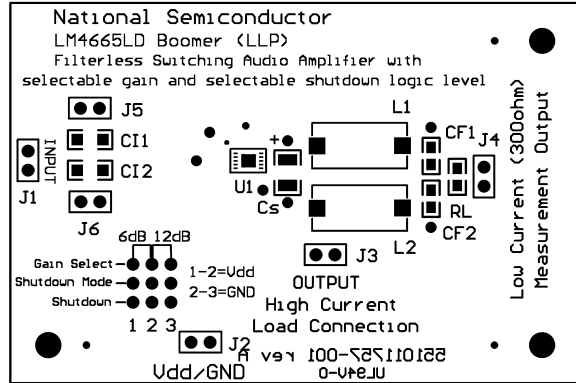

200270D2

Top Layer

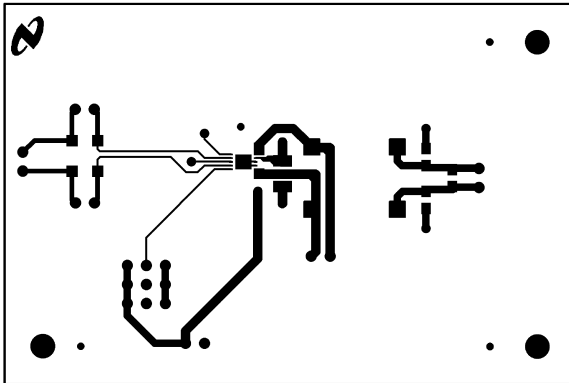

200270D3

Bottom Layer

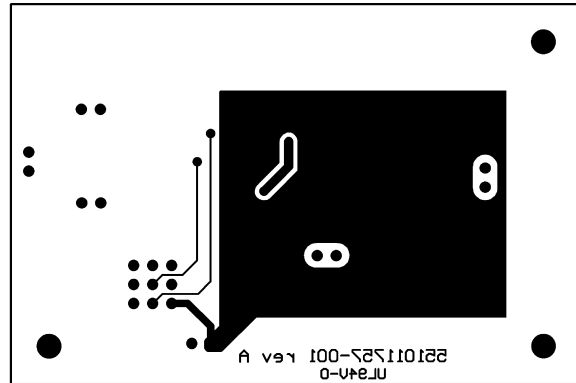

200270D4

Application Information (Continued)

LM4665 micro SMD BOARD ARTWORK

Composite View

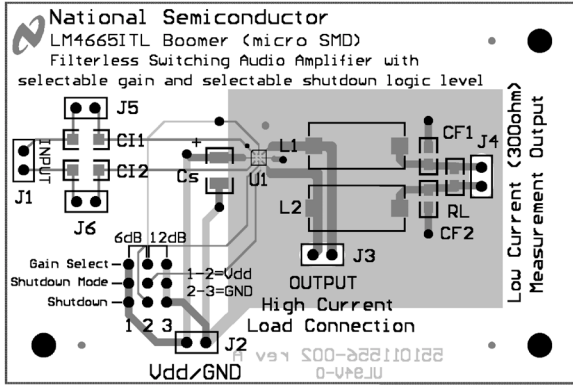

Silk Screen

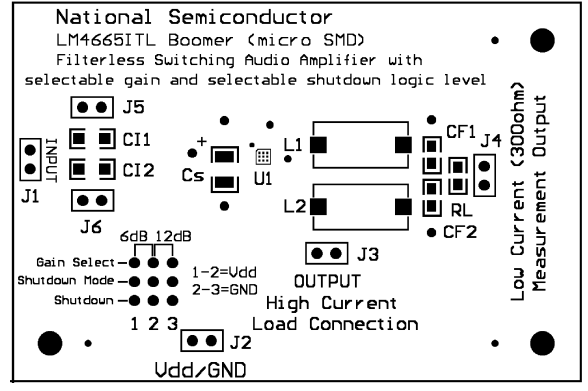

Top Layer

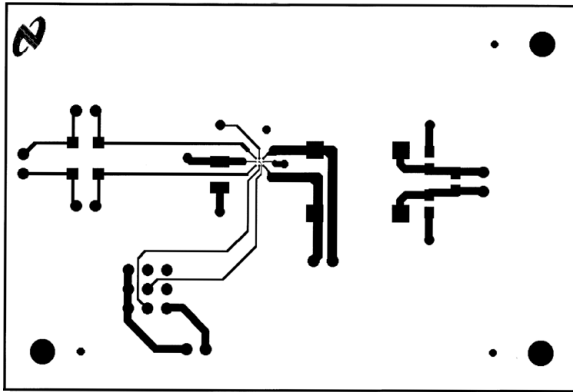

Bottom Layer

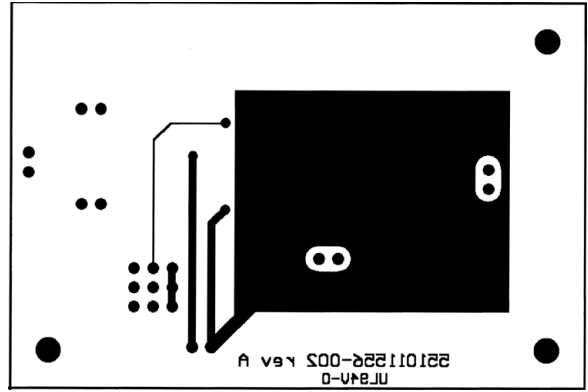

Physical Dimensions inches (millimeters) unless otherwise noted

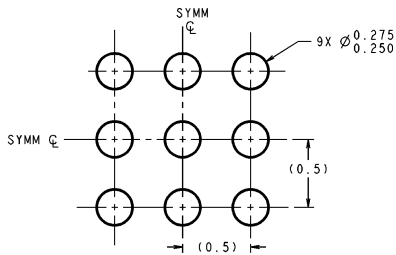

DIMENSIONS ARE IN MILLIMETERS

LAND PATTERN RECOMMENDATION

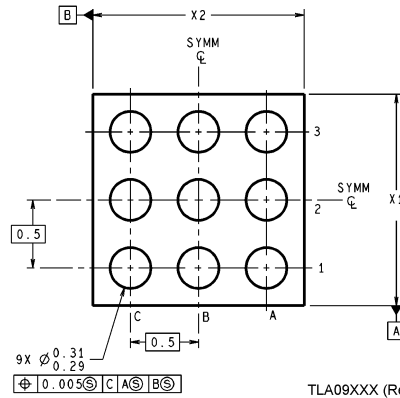
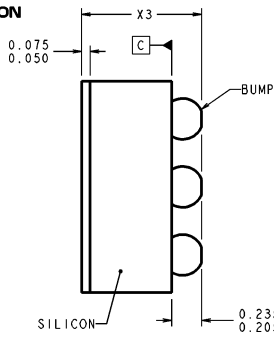
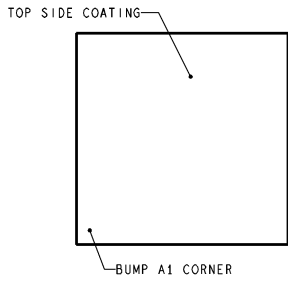

TLA09XXX (Rev A)

9 Bump micro SMD
Order Number LM4665ITL, LM4665ITLX
NS Package Number TLA09AAA
X₁ = 1.514 X₂ = 1.514 X₃ = 0.600

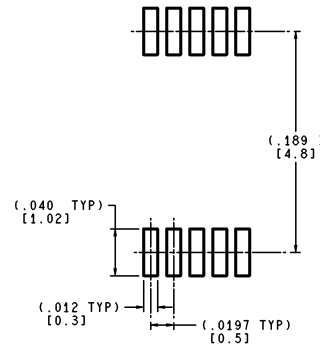
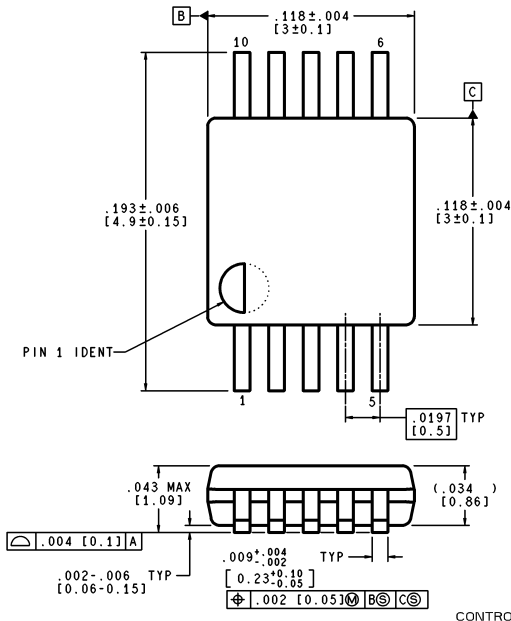

LAND PATTERN RECOMMENDATION

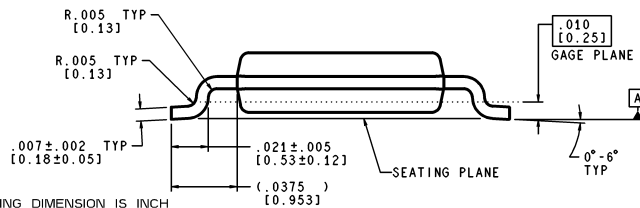

CONTROLLING DIMENSION IS INCH
 VALUES IN () ARE MILLIMETERS

MUB10A (Rev A)

Mini Small Outline (MSOP)
Order Number LM4665MM
NS Package Number MUB10A

Physical Dimensions inches (millimeters) unless otherwise noted (Continued)

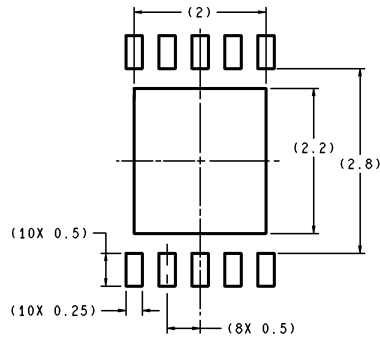

RECOMMENDED LAND PATTERN
1:1 RATIO WITH PKG SOLDER PADS

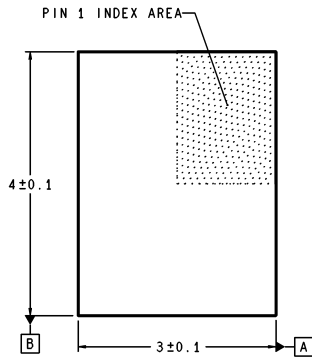

DIMENSIONS ARE IN MILLIMETERS

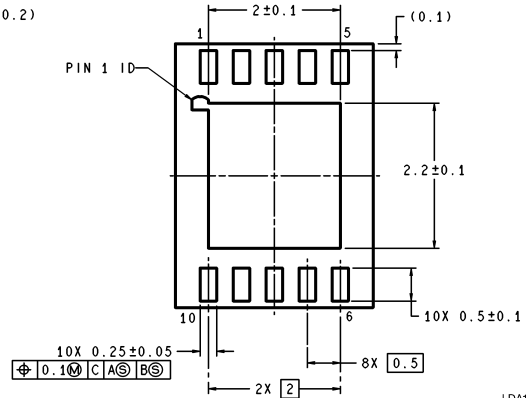
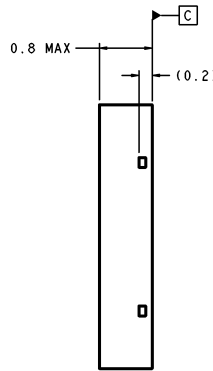

LDA10B (Rev A)

LLP
Order Number LM4665LD
NSPackage Number LDA10B

LIFE SUPPORT POLICY

NATIONAL'S PRODUCTS ARE NOT AUTHORIZED FOR USE AS CRITICAL COMPONENTS IN LIFE SUPPORT DEVICES OR SYSTEMS WITHOUT THE EXPRESS WRITTEN APPROVAL OF THE PRESIDENT AND GENERAL COUNSEL OF NATIONAL SEMICONDUCTOR CORPORATION. As used herein:

1. Life support devices or systems are devices or systems which, (a) are intended for surgical implant into the body, or (b) support or sustain life, and whose failure to perform when properly used in accordance with instructions for use provided in the labeling, can be reasonably expected to result in a significant injury to the user.
2. A critical component is any component of a life support device or system whose failure to perform can be reasonably expected to cause the failure of the life support device or system, or to affect its safety or effectiveness.



National Semiconductor
Americas Customer Support Center
Email: new.feedback@nsc.com
Tel: 1-800-272-9959

www.national.com

National Semiconductor
Europe Customer Support Center
Fax: +49 (0) 180-530 85 86
Email: europe.support@nsc.com
Deutsch Tel: +49 (0) 69 9508 6208
English Tel: +44 (0) 870 24 0 2171
Français Tel: +33 (0) 1 41 91 8790

National Semiconductor
Asia Pacific Customer Support Center
Fax: 65-6250 4466
Email: ap.support@nsc.com
Tel: 65-6254 4466

National Semiconductor
Japan Customer Support Center
Fax: 81-3-5639-7507
Email: nsj.crc@jksmtp.nsc.com
Tel: 81-3-5639-7560

IMPORTANT NOTICE

Texas Instruments Incorporated and its subsidiaries (TI) reserve the right to make corrections, modifications, enhancements, improvements, and other changes to its products and services at any time and to discontinue any product or service without notice. Customers should obtain the latest relevant information before placing orders and should verify that such information is current and complete. All products are sold subject to TI's terms and conditions of sale supplied at the time of order acknowledgment.

TI warrants performance of its hardware products to the specifications applicable at the time of sale in accordance with TI's standard warranty. Testing and other quality control techniques are used to the extent TI deems necessary to support this warranty. Except where mandated by government requirements, testing of all parameters of each product is not necessarily performed.

TI assumes no liability for applications assistance or customer product design. Customers are responsible for their products and applications using TI components. To minimize the risks associated with customer products and applications, customers should provide adequate design and operating safeguards.

TI does not warrant or represent that any license, either express or implied, is granted under any TI patent right, copyright, mask work right, or other TI intellectual property right relating to any combination, machine, or process in which TI products or services are used. Information published by TI regarding third-party products or services does not constitute a license from TI to use such products or services or a warranty or endorsement thereof. Use of such information may require a license from a third party under the patents or other intellectual property of the third party, or a license from TI under the patents or other intellectual property of TI.

Reproduction of TI information in TI data books or data sheets is permissible only if reproduction is without alteration and is accompanied by all associated warranties, conditions, limitations, and notices. Reproduction of this information with alteration is an unfair and deceptive business practice. TI is not responsible or liable for such altered documentation. Information of third parties may be subject to additional restrictions.

Resale of TI products or services with statements different from or beyond the parameters stated by TI for that product or service voids all express and any implied warranties for the associated TI product or service and is an unfair and deceptive business practice. TI is not responsible or liable for any such statements.

TI products are not authorized for use in safety-critical applications (such as life support) where a failure of the TI product would reasonably be expected to cause severe personal injury or death, unless officers of the parties have executed an agreement specifically governing such use. Buyers represent that they have all necessary expertise in the safety and regulatory ramifications of their applications, and acknowledge and agree that they are solely responsible for all legal, regulatory and safety-related requirements concerning their products and any use of TI products in such safety-critical applications, notwithstanding any applications-related information or support that may be provided by TI. Further, Buyers must fully indemnify TI and its representatives against any damages arising out of the use of TI products in such safety-critical applications.

TI products are neither designed nor intended for use in military/aerospace applications or environments unless the TI products are specifically designated by TI as military-grade or "enhanced plastic." Only products designated by TI as military-grade meet military specifications. Buyers acknowledge and agree that any such use of TI products which TI has not designated as military-grade is solely at the Buyer's risk, and that they are solely responsible for compliance with all legal and regulatory requirements in connection with such use.

TI products are neither designed nor intended for use in automotive applications or environments unless the specific TI products are designated by TI as compliant with ISO/TS 16949 requirements. Buyers acknowledge and agree that, if they use any non-designated products in automotive applications, TI will not be responsible for any failure to meet such requirements.

Following are URLs where you can obtain information on other Texas Instruments products and application solutions:

Products

Audio	www.ti.com/audio
Amplifiers	amplifier.ti.com
Data Converters	dataconverter.ti.com
DLP® Products	www.dlp.com
DSP	dsp.ti.com
Clocks and Timers	www.ti.com/clocks
Interface	interface.ti.com
Logic	logic.ti.com
Power Mgmt	power.ti.com
Microcontrollers	microcontroller.ti.com
RFID	www.ti-rfid.com
OMAP Mobile Processors	www.ti.com/omap
Wireless Connectivity	www.ti.com/wirelessconnectivity

Applications

Communications and Telecom	www.ti.com/communications
Computers and Peripherals	www.ti.com/computers
Consumer Electronics	www.ti.com/consumer-apps
Energy and Lighting	www.ti.com/energy
Industrial	www.ti.com/industrial
Medical	www.ti.com/medical
Security	www.ti.com/security
Space, Avionics and Defense	www.ti.com/space-avionics-defense
Transportation and Automotive	www.ti.com/automotive
Video and Imaging	www.ti.com/video

TI E2E Community Home Page

e2e.ti.com

Mailing Address: Texas Instruments, Post Office Box 655303, Dallas, Texas 75265
Copyright © 2011, Texas Instruments Incorporated