



MOTOROLA

**MC1463
MC1563**

**Specifications and Applications
Information**

NEGATIVE VOLTAGE REGULATOR

The MC1563/MC1463 is a "three terminal" negative regulator designed to deliver continuous load current up to 500 mA dc and provide a maximum negative input voltage of -40 Vdc. Output current capability can be increased to greater than 10 Adc through use of one or more external transistors.

Specifications and performance of the MC1563/MC1463 Negative Voltage Regulator are nearly identical to the MC1569/MC1469 Positive Voltage Regulator. For systems requiring both a positive and negative power supply, these devices are excellent for use as complementary regulators and offer the advantage of operating with a common input ground.

The MC1563R/MC1463R case can be mounted directly to a grounded heat sink which eliminates the need for an insulator.

- Case is at Ground Potential (R package)
- Electronic "Shutdown" and Short-Circuit Protection
- Low Output Impedance - 20 Milliohms typical
- High Power Capability - 9.0 Watts
- Excellent Temperature Stability - $\Delta V_O/\Delta T = \pm 0.002\%/^{\circ}C$ typical
- High Ripple Rejection - 0.002% typical
- 500 mA Current Capability

**NEGATIVE-POWER-SUPPLY
VOLTAGE REGULATOR**

**SILICON MONOLITHIC
INTEGRATED CIRCUIT**

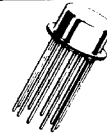

**G SUFFIX
METAL PACKAGE
CASE 603-04**



**R SUFFIX
METAL PACKAGE
CASE 614-02**

FIGURE 1 - TYPICAL CIRCUIT CONNECTION
($-3.5 \leq V_O \leq -37$) Vdc, $1 \leq I_L \leq 500$ mA)

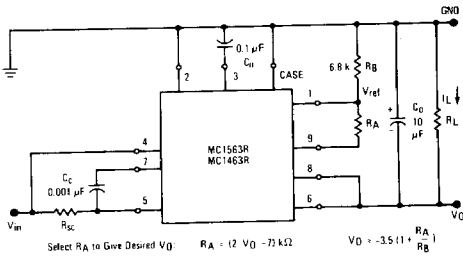
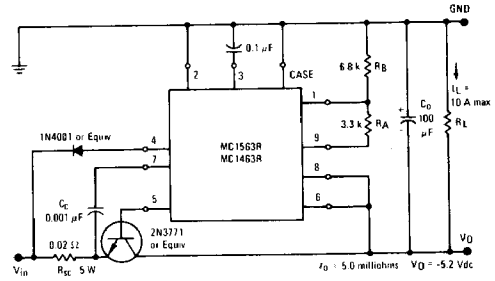
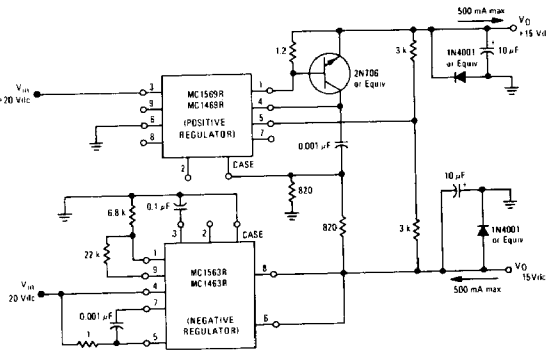

FIGURE 2 - TYPICAL NPN CURRENT BOOST CONNECTION
($V_O = 5.2$ Vdc, $I_L = 10$ Adc [max])



**FIGURE 3 - ± 15 V, ± 400 mA COMPLEMENTARY TRACKING
VOLTAGE REGULATOR**



ORDERING INFORMATION

DEVICE	TEMPERATURE RANGE	PACKAGE
MC1463G	0° C to +70° C	Metal Can
MC1463R	0° C to +70° C	Metal Power
MC1563G	-55° C to +125° C	Metal Can
MC1563R	-55° C to +125° C	Metal Power

MAXIMUM RATINGS (T_C = +25°C unless otherwise noted.)

Rating	Symbol	Value		Unit
Input Voltage MC1463 MC1563	V _I	-35 -40		Vdc
Load Current -- Peak	I _L	G Package	R Package	mA
		250	600	
Current, Pin 2	I ₂	10	10	mA
Power Dissipation and Thermal Characteristics T _A = 25°C Derate above T _A = 25°C Thermal Resistance, Junction to Air T _C = 25°C Derate above T _C = 25°C Thermal Resistance, Junction to Case	P _D	0.68	2.4	Watts
	1/R _{θJA}	5.44	16	mW/°C
	R _{θJA}	184	62	°C/W
	P _D	1.8	9.0	Watts
	1/R _{θJC}	14.4	61	mW/°C
	R _{θJC}	69.4	17	°C/W
Operating and Storage Junction Temperature Range	T _J , T _{stg}	-65 to +150		°C

4

OPERATING TEMPERATURE RANGE

Operating Ambient Temperature Range	T _A	°C
MC1463 MC1563	0 to +70 -55 to +125	°C

ELECTRICAL CHARACTERISTICS (I_L = 100 mAdc, T_C = +25°C, V_{in} = 15 V, V_O = 10 V unless otherwise noted.)

Characteristic	Fig.	Note	Symbol	MC1563			MC1463			Unit
				Min	Typ	Max	Min	Typ	Max	
Input Voltage (T _A = T _{low} ① to T _{high} ② I _L = 1.0 mA)	4	1,6	V _I	-8.5	-	-40	-9.0	-	-35	Vdc
Output Voltage Range (I _L = 1.0 mA)	4	-	V _O	-3.6	-	-37	-3.8	-	-32	Vdc
Reference Voltage (Pin 1 to Ground)	4	-	V _{ref}	-3.4	-3.5	-3.6	-3.2	-3.5	-3.8	Vdc
Minimum Input-Output Voltage Differential (R _{sc} = 0)	4	2	V _{in} - V _O	-	1.5	2.7	-	1.5	3.0	Vdc
Bias Current (Standby Current) (I _L = 1.0 mAdc, I _{IB} = I _I - I _L)	4	-	I _{IB}	-	7.0	11	-	7.0	14	mAdc
Output Noise (C _n = 0.1 μF, f = 10 Hz to 5.0 MHz)	4	-	v _N	-	120	-	120	-	-	μV(rms)
Temperature Coefficient of Output Voltage	4	3	ΔV _O /ΔT	-	±0.002	-	±0.002	-	-	%/°C
Operating Load Current Range (R _{sc} = 0.3 ohm) R Package (R _{sc} = 2.0 ohms) G Package	4	-	I _{LR}	1.0	-	500	1.0	-	500	mAdc
				1.0	-	200	1.0	-	200	
Input Regulation (V _{in} = 1.0 V rms, f = 1.0 kHz)	4	4	Reg _{line}	-	0.002	0.015	-	0.003	0.030	%/V _O
Load Regulation (T _J = Constant [1.0 mA ≤ I _L ≤ 20 mA]) (T _C = +25°C [1.0 mA ≤ I _L ≤ 50 mA]) R Package G Package	6	5	Reg _{load}	-	0.4	1.6	-	0.7	2.4	mV
				-	0.005	0.05	-	0.005	0.05	%
				-	0.01	0.13	-	0.01	0.13	
Output Impedance (f = 1.0 kHz)	7	-	z _o	-	20	-	35	-	milliohms	
Shutdown Current (V _I = -35 Vdc)	8	-	I _{sd}	-	7.0	15	-	14	50	μAdc

① T_{low} = 0°C for MC1463
= -55°C for MC1563

② T_{high} = +70°C for MC1463
= +125°C for MC1563

Heat sink required for T_{high} testing of "G" package.

Note 1. "Minimum Input Voltage" is the minimum "total instantaneous input voltage" required to properly bias the internal zener reference diode.

Note 2. This parameter states that the MC1563/MC1463 will regulate properly with the input-output voltage differential $|V_I - V_O|$ as low as 2.7 Vdc and 3.0 Vdc respectively. Typical units will regulate properly with $|V_I - V_O|$ as low as 1.5 Vdc as shown in the typical column.

Note 3. "Temperature Coefficient of Output Voltage" is defined as:

$$\Delta V_O / \Delta T = \frac{+(V_O \text{ max} - V_O \text{ min}) (100)}{\Delta T_A |V_O @ T_A = +25^\circ\text{C}|}$$

where $\Delta T_A = +180^\circ\text{C}$ for the MC1563
 $+75^\circ\text{C}$ for the MC1463

The output-voltage adjusting resistors (R_A and R_B) must have matched temperature characteristics in order to maintain a constant ratio independent of temperature.

Note 4. Input regulation is the percentage change in output voltage per volt change in the input voltage and is expressed as

$$\text{Input Regulation} = \frac{V_O}{V_O (V_I)} 100 (\%/V_O)$$

where V_O is the change in the output voltage V_O for the input change v_{in} .

The following example illustrates how to compute maximum output voltage change for the conditions given:

$$\begin{aligned} \text{Regin} &= 0.015\%/V_O \\ V_O &= 10 \text{ Vdc} \\ v_{in} &= 1.0 \text{ V(rms)} \end{aligned}$$

$$\begin{aligned} V_O &= \frac{(\text{Regline}) (V_I) (V_O)}{100 \text{ I}} \\ &= \frac{(0.015)(1.0)(10)}{100} \\ &= 0.0015 \text{ V(rms)} \end{aligned}$$

Note 5. Temperature drift effect must be taken into account separately for conditions of high junction temperature changes due to the thermal feedback that exists on the monolithic chip.

$$\text{Load Regulation} = \frac{V_O |_{I_L = 1.0 \text{ mA}} - V_O |_{I_L = 50 \text{ mA}}}{V_O |_{I_L = 1.0 \text{ mA}}} \times 100$$

Note 6. Not to exceed maximum package power dissipation.

TEST CIRCUITS

($I_L = 100 \text{ mAdc}$, $T_C = +25^\circ\text{C}$ unless otherwise noted.)

FIGURE 4 - GENERAL TEST CIRCUIT

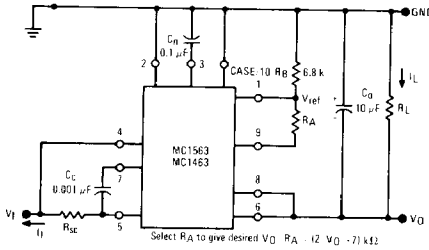

FIGURE 5 - LOAD TRANSIENT RESPONSE

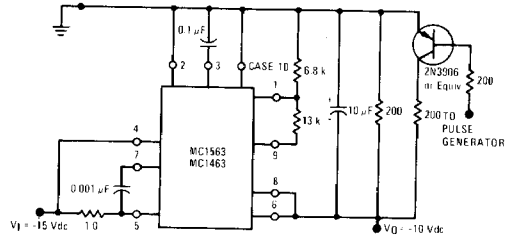

FIGURE 6 - LOAD REGULATION

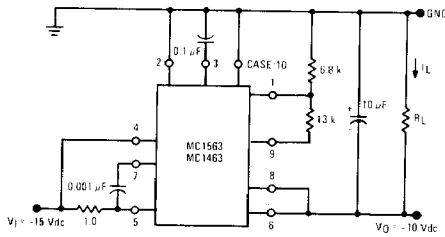

FIGURE 7 - OUTPUT IMPEDANCE

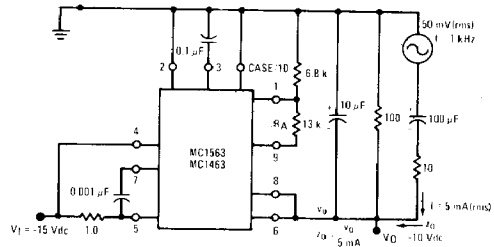
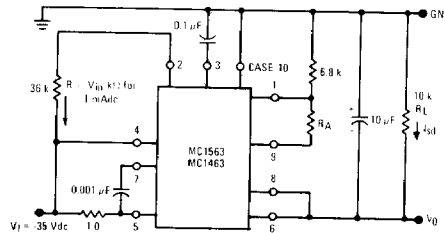

FIGURE 8 - SHUTDOWN CURRENT



GENERAL DESIGN INFORMATION

1. Output Voltage, V_O
 - a) Output Voltage is set by resistors R_A and R_B (see Figure 9). Set $R_B = 6.8 \text{ k}$ ohms and determine R_A from the graph of Figure 11 or from the equation:

$$R_A \approx (2 |V_O| - 7) \text{ k}\Omega$$
 - b) Output voltage can be varied by making R_A adjustable as shown in Figures 9 and 10.
 - c) Output voltage, V_O , is determined by the ratio of R_A and R_B therefore optimum temperature performance can be achieved if R_A and R_B have the same temperature coefficient.
 - d) $V_O = V_{\text{ref}} (1 + \frac{R_A}{R_B})$; therefore the tolerance on output voltage is determined by the tolerance of V_{ref} and R_A and R_B .

2. Short-Circuit Current, I_{SC}

Short-Circuit Current, I_{SC} is determined by R_{SC} . R_{SC} may be chosen with the aid of Figure 11 when using the typical circuit connection of Figure 9. See Figure 27 for current limiting during NPN current boost.

3. Compensation, C_C

A $0.001 \mu\text{F}$ capacitor (C_C , see Figure 9), will provide adequate compensation in most applications, with or without current boost. Smaller values of C_C will reduce stability and larger values of C_C will degrade pulse response and output impedance versus frequency. The physical location of C_C should be close to the MC1563/MC1463 with short lead lengths.

4. Noise Filter Capacitor, C_N

A $0.1 \mu\text{F}$ capacitor, C_N , from Pin 3 to ground will typically reduce the output noise voltage to $120 \mu\text{V}$ (rms). The value of C_N can be increased or decreased, depending on the noise voltage requirements of a particular application. A minimum value of $0.001 \mu\text{F}$ is recommended.

5. Output Capacitor, C_O

The value of C_O should be at least $10 \mu\text{F}$ in order to provide good stability.

6. Shutdown Control

One method of turning "OFF" the regulator is to draw 1 mA from Pin 2 (See Figure 8). This control can be used to eliminate power consumption by circuit loads which can be put in "standby" mode. Examples include, an ac or dc "squelch" control for communications circuits, and a dissipation control to protect the regulator under sustained output short-circuiting. As the magnitude of the input-threshold voltage at Pin 2 depends directly upon the junction temperature of the integrated circuit chip, a fixed dc voltage at Pin 2 will cause automatic shutdown for high junction temperatures (see Figure 35). This will protect the chip, independent of the heat sinking used, the ambient temperature, or the input or output voltage levels. Standard logic levels of MECL, MRTL, MDTL or MTTL can also be used to turn the regulator "ON" or "OFF" (see Figures 30 and 31).

7. Remote Sensing

The connection to Pin 8 can be made with a separate lead direct to the load. Thus, "remote sensing" can be achieved and the effect of undesired impedances (including that of the milliammeter used to measure I_L) on z_o can be greatly reduced (see Figure 33).

MECL, MOTL, MRTL, and MTTL are Trademarks of Motorola Inc.

FIGURE 9 - TYPICAL CIRCUIT CONNECTION

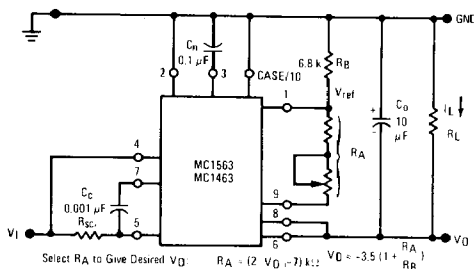

FIGURE 10 - R_A versus V_O

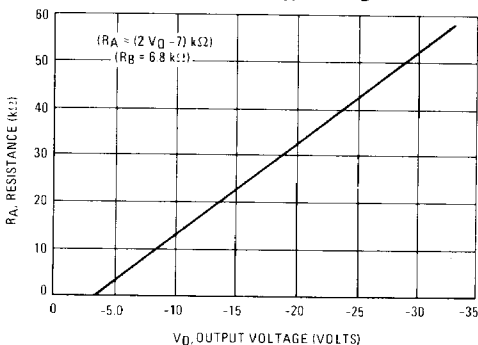
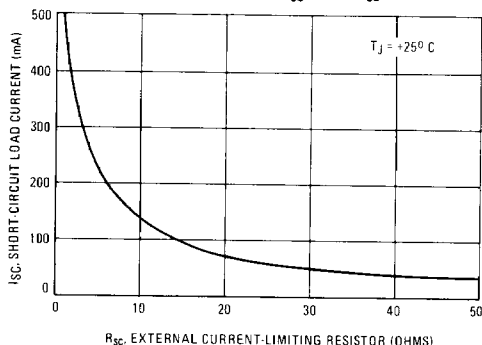

FIGURE 11 - I_{SC} versus R_{SC}



TYPICAL CHARACTERISTICS

Unless otherwise noted: $C_n = 0.1 \mu F$, $C_c = 0.001 \mu F$, $C_o = 10 \mu F$, $T_C = +25^\circ C$,
 $V_I(\text{nom}) = -15 \text{ Vdc}$, $V_O(\text{nom}) = -10 \text{ Vdc}$, $I_L = 100 \text{ mAdc}$.

FIGURE 12 – TEMPERATURE DEPENDENCE OF SHORT-CIRCUIT LOAD CURRENT

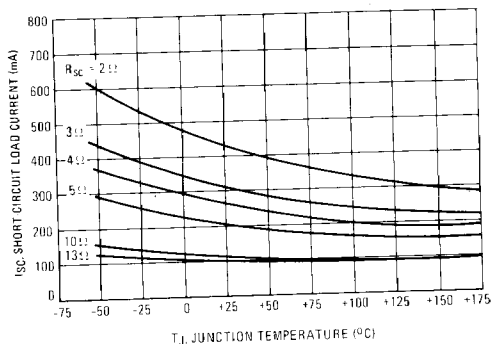

FIGURE 13 – FREQUENCY DEPENDENCE OF OUTPUT IMPEDANCE

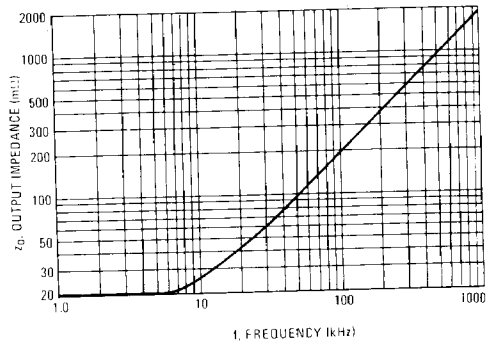

FIGURE 14 – DEPENDENCE OF OUTPUT IMPEDANCE ON OUTPUT VOLTAGE

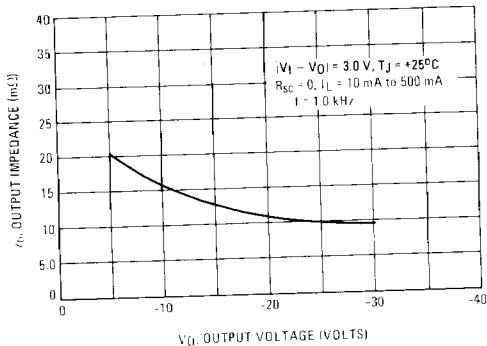

FIGURE 15 – OUTPUT IMPEDANCE versus R_{sc}

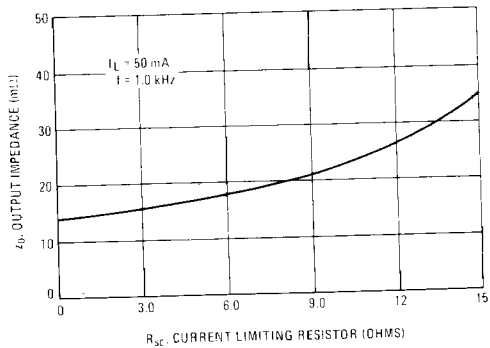
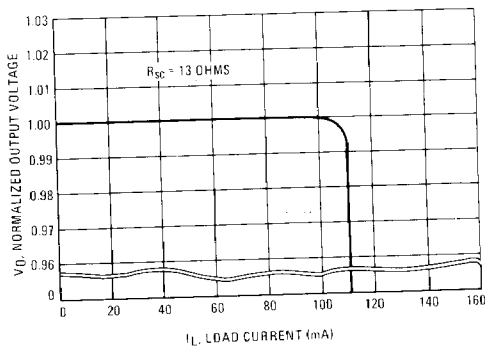

FIGURE 16 – CURRENT LIMITING CHARACTERISTICS



TYPICAL CHARACTERISTICS (continued)

FIGURE 17 — BIAS CURRENT versus INPUT VOLTAGE

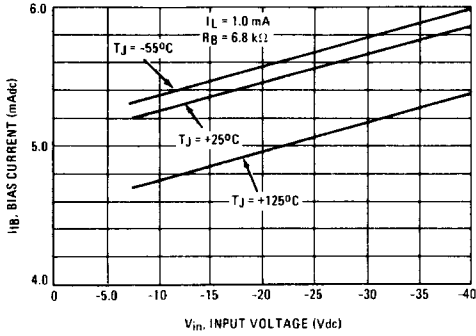

FIGURE 18 — EFFECTS OF LOAD CURRENT ON INPUT-OUTPUT VOLTAGE DIFFERENTIAL

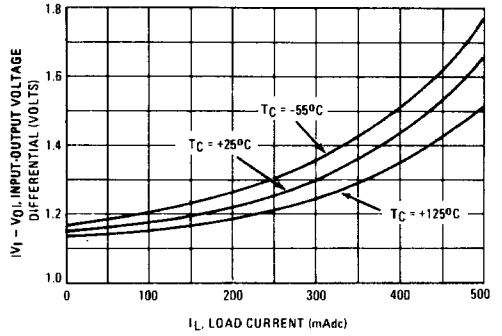

FIGURE 19 — EFFECT OF INPUT-OUTPUT VOLTAGE DIFFERENTIAL ON INPUT REGULATION

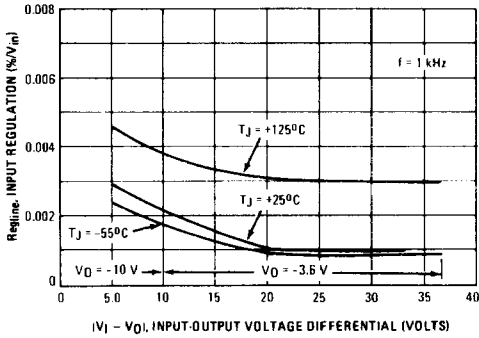

FIGURE 20 — INPUT TRANSIENT RESPONSE

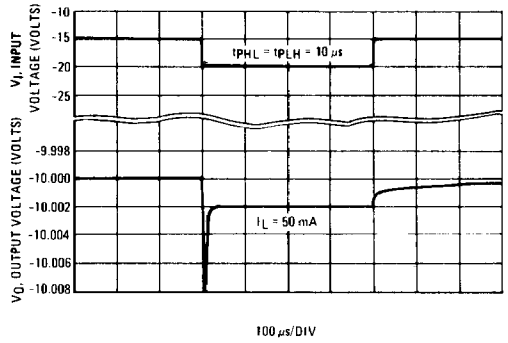

FIGURE 21 — LOAD TRANSIENT RESPONSE

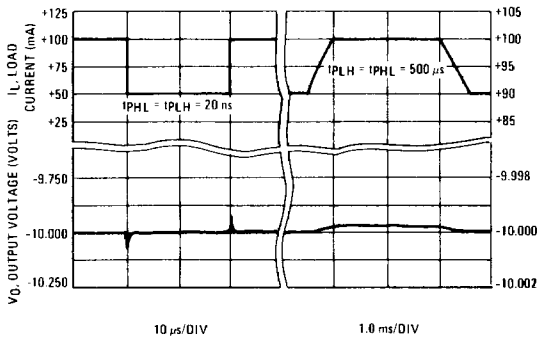
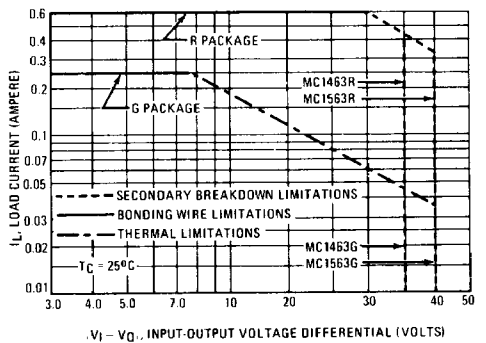

FIGURE 22 — DC OPERATING AREA



OPERATION AND APPLICATIONS

This section describes the operation and design of the MC1563 (MC1463) negative voltage regulator and also provides information on useful applications.

SUBJECT SEQUENCE INDEX

	Specification Pg. No.		Specification Pg. No.
Theory of Operation	7	Remote Sensing	12
NPN Current Boosting	9	An Adjustable Zero-Temperature-Coefficient Voltage Source	13
PNP Current Boosting	10	Thermal Shutdown	13
Positive and Negative Power Supplies	11	Thermal Considerations	13
Shutdown Techniques	11	PC Board Layout and Information	15
Voltage Boosting	12		

THEORY OF OPERATION

The usual series voltage regulator shown in Figure 23, consists of a reference voltage, an error amplifier, and a series control element. The error amplifier compares the output voltage with the reference voltage and adjusts the output accordingly until the error is essentially zero. For applications requiring output voltages larger than the reference, there are two options. The first is to use a resistive divider across the output and compare only a fraction of the output voltage to the reference. This approach suffers from reduced feedback to the error amplifier due to the attenuation of the resistive divider. This degrades load regulation especially at high voltage levels.

The alternative is to eliminate the resistive divider and to shift the reference voltage instead. To accomplish this, another amplifier is employed to amplify (or level shift) the reference voltage using an operational amplifier as shown in Figure 24. The gain-determining resistors may be external, enabling a wide range of output voltages. This

is exactly the same approach used in the first option. That is, the output is being resistively divided to match the reference voltage. There is however, one big difference in that the output of this "regulator" is driving the input of another regulator (the error amplifier). The output of the reference amplifier has a relatively low impedance as compared to the input impedance of the error amplifier. Changes in the load of the output of the error amplifier are buffered to the extent that they have virtually no effect on the reference amplifier. If the feedback resistors are external (as they are on the MC1563) a wide range of reference voltages can be established.

The error amplifier can now be operated at unity gain to provide excellent regulation. In fact, this "regulator-within-a-regulator" concept permits the load regulation to be specified in terms of output impedance rather than as some percentage change of the output voltage. This approach was used in the design of the MC1563 negative voltage regulator.

FIGURE 23 — SERIES VOLTAGE REGULATOR

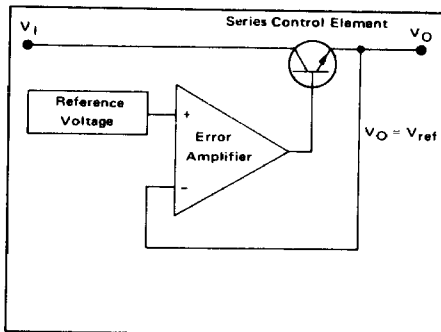

FIGURE 24 — THE "REGULATOR-WITHIN-A-REGULATOR" APPROACH

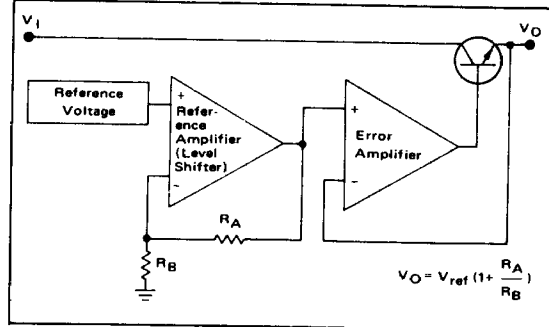
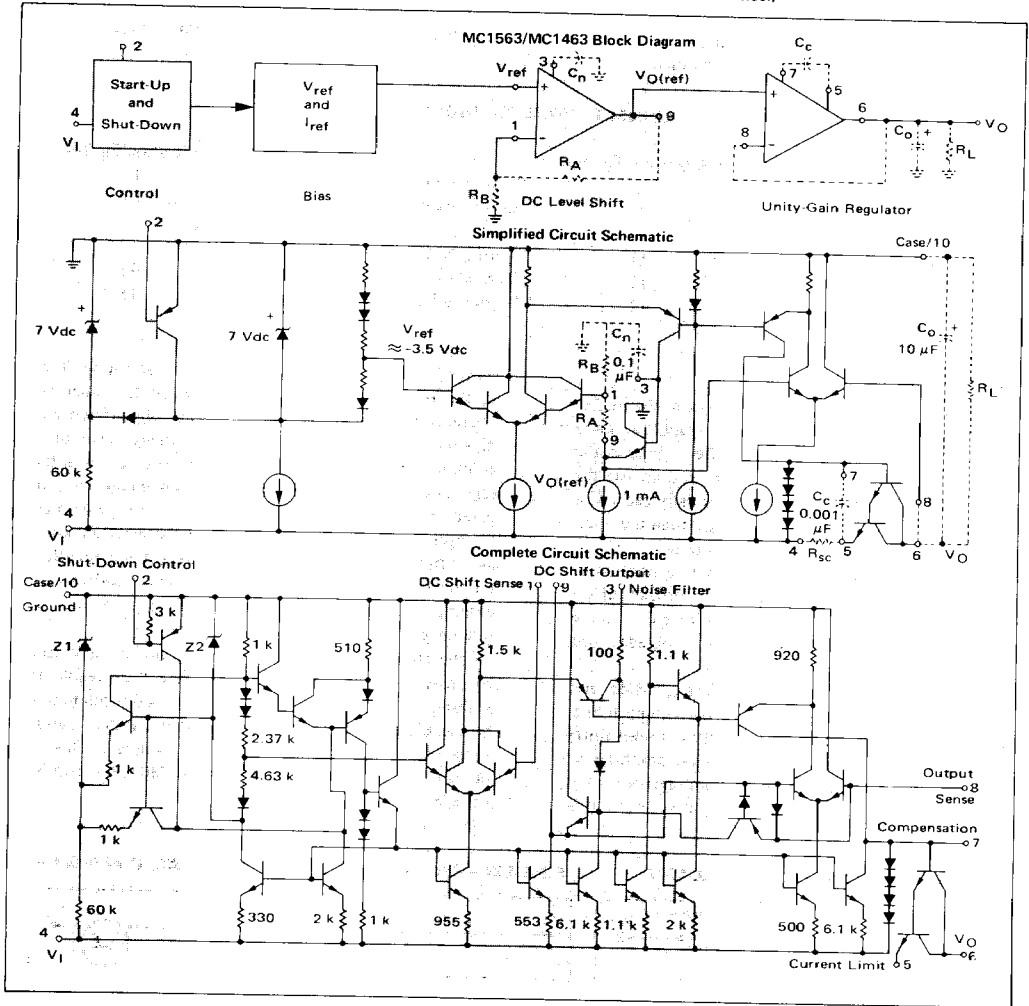

FIGURE 25
(Recommended External Circuitry is Depicted With Dotted Lines.)



4

MC1563 (MC1463) Operation

Figure 25 shows the MC1563 (MC1463) Negative Regulator block diagram, simplified schematic, and complete schematic. The four basic sections of the regulator are: Control, Bias, DC Level Shift, and Output (unity gain) Regulator. Each section is detailed in the following paragraphs.

Control

The control section involves two basic functions, start-up and shutdown. A start-up function is required since the biasing is essentially independent of the unregulated

input voltage. It makes use of two zener diodes having the same breakdown voltage. A first or auxiliary zener is driven directly from the input voltage line through a resistor (60 kΩ) and permits the regulator to initially achieve the desired bias conditions. This permits the second, or reference zener to be driven from a current source. When the reference zener enters breakdown, the auxiliary zener is isolated from the rest of the regulator circuitry by a diode disconnect technique. This is necessary to keep the added noise and ripple of the auxiliary zener from degrading the performance of the regulator.

MC1463, MC1563

The shutdown control, in effect, consists of a PNP transistor across the reference zener diode. When this transistor is turned "ON", via Pin 2, the reference voltage is reduced to essentially zero volts and the regulator is forced to shutdown. During shutdown the current drain of the complete IC regulator drops to $V_{in}/60 \text{ k}\Omega$ or $500 \mu\text{A}$ for a -30 V input.

Bias

A zener diode is the main reference element and forms the heart of the bias circuitry. Its positive temperature coefficient is balanced by the negative temperature coefficients of forward biased diodes in a ratio determined by the resistors in the diode string. The result is a reference voltage of approximately -3.5 Vdc with a typical temperature coefficient of $0.002\%/^{\circ}\text{C}$. In addition, this circuit also provides a reference current which is used to bias all current sources in the remaining regulator circuitry.

DC Level Shift

The reference voltage is used as the input to a Darlington differential amplifier. The gain of this amplifier is quite high and it therefore may be considered to function as a conventional operational amplifier. Consequently, negative feedback can be employed using two external resistors (R_A and R_B) to set the closed-loop gain and to boost the reference voltage to the desired output voltage. A capacitor, C_N , is introduced externally into the level shift network (via Pin 3) to stabilize the amplifier and to filter the zener noise. The recommended value for this capacitor is $0.1 \mu\text{F}$ and should have a voltage rating in excess of the desired output voltage. Smaller capacitors ($0.001 \mu\text{F}$ minimum) may be used but will cause a slight increase in output noise. Larger values of C_N will reduce the noise as well as delay the start-up of the regulator.

Output Regulator

The output of the shift amplifier is fed internally to the noninverting input of the output error amplifier. The

inverting input to this amplifier is the Output Sense connection (Pin 8) of the regulator. A Darlington connected NPN power transistor is used to handle the load current. The short-circuit current limiting resistor, R_{SC} , is connected in the emitter of this transistor to sample the full load current. This connection enables a four-diode string to limit the drive current to the power transistors in a conventional manner.

Stability and Compensation

As has been seen, the MC1563 employs two amplifiers, each using negative feedback. This implies the possibility of frequency instability due to excessive phase shift at high frequencies. Since the error amplifier is normally used at unity gain (the worst case for stability) a high impedance node is brought out for compensation. For normal operation, a capacitor is connected between this point (Pin 7) and Pin 5. The recommended value of $0.001 \mu\text{F}$ will insure stability and still provide acceptable transient response (see Figure 21). It is also necessary to use an output capacitor, C_O , (typically $10 \mu\text{F}$) directly from the output (Pin 6) to ground. When an external transistor is used to boost the current, $C_O = 100 \mu\text{F}$ is recommended (see Figure 26).

NPN CURRENT BOOSTING

For applications requiring more than 500 mA of load current, or for minimizing voltage variations due to temperature changes in the IC regulator arising from changes of the internal power dissipation, the NPN current-boost circuits of Figure 2 or 26, are recommended. The circuit shown in Figure 26 can supply up to approximately 4.0 amperes (subject to safe area limitations). At higher currents the V_{BE} of the pass transistor may itself exceed the threshold of the current limit even for $R_{SC} = 0$. Figure 2 illustrates the use of an additional external diode from Pin 4 for higher current operation or for pass transistors exhibiting higher V_{BE} 's. It will probably be necessary to determine R_{SC} experimentally for each case where a pass transistor is used because V_{BE} varies from device to device. The circuit of Figure 26 when set up for a -10 V output

FIGURE 26 — TYPICAL NPN CURRENT BOOST CONNECTION

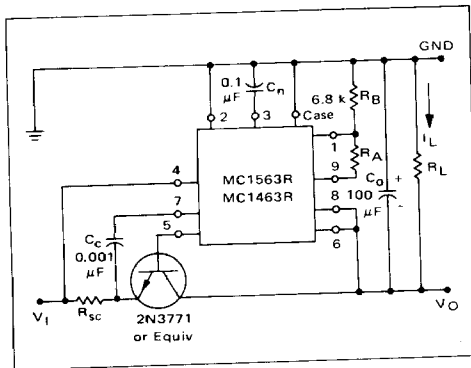
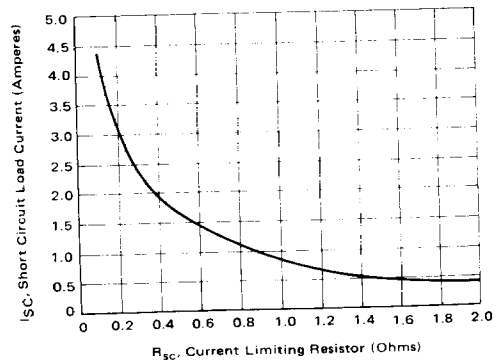

FIGURE 27 — I_{SC} versus R_{SC} (REFERENCE FIGURE 26)



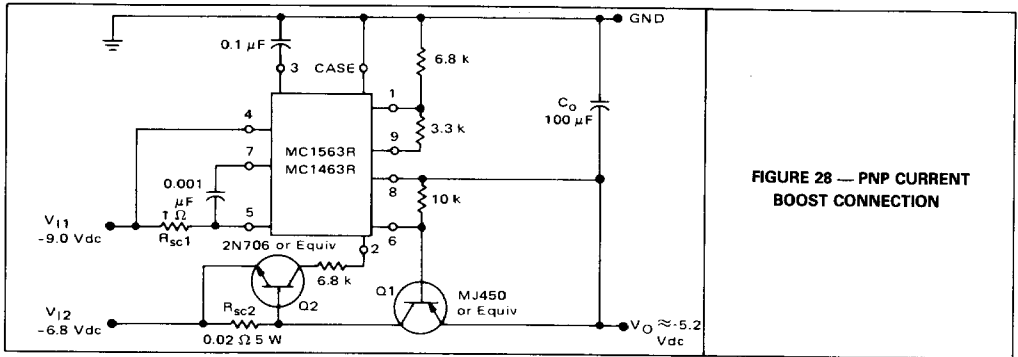

FIGURE 28 — PNP CURRENT BOOST CONNECTION

($R_A = 13 \text{ k}\Omega$) supply and operating with a -15 V input, with a R_{SC} of 0.1Ω , will yield a change in output voltage of only 26 mV over a load current range of from 1 mA to 3.5 A . This corresponds to a dc output impedance of only 7.5 milliohms or a percentage load regulation of 0.26% for a full 3.5-ampere load current change. Figure 27 indicates how the short circuit current varies with the value of R_{SC} for this circuit.

PNP CURRENT BOOSTING

A PNP power transistor can also be used to boost the load current capabilities. To improve the efficiency of the PNP boost configuration, particularly for small output voltages, the circuit of Figure 28, is recommended. An auxiliary -9 volt supply is used to power the IC regulator and the heavy load current is obtained from a second supply of lower voltage. For the 10-ampere regulator of Figure

28 this represents a savings of 22 watts when compared with operating the regulator from the single -9 V supply. It can supply current to 10 amperes while requiring an input voltage to the collector of the pass transistor of -6.8 volts minimum. The pass transistor is limited to 10 amperes by the added short-circuit current network in its emitter (R_{SC2}) and the IC regulator is limited to 500 mA in the conventional manner (R_{SC1}). The MJ450 exhibits a minimum h_{FE} of 20 at 10 amperes , thus requiring only 500 mA from the MC1563R. Regulation of this circuit is comparable to that of the NPN boost configuration.

For higher output voltages the additional unregulated power supply is not required. The collector of the PNP boost transistor can tie directly to Pin 5 and the internal current limit circuit will provide short-circuit protection using R_{SC} (see Figure 11). Transistor Q2 and R_{SC2} will not be required and Pin 2 should be returned to ground.

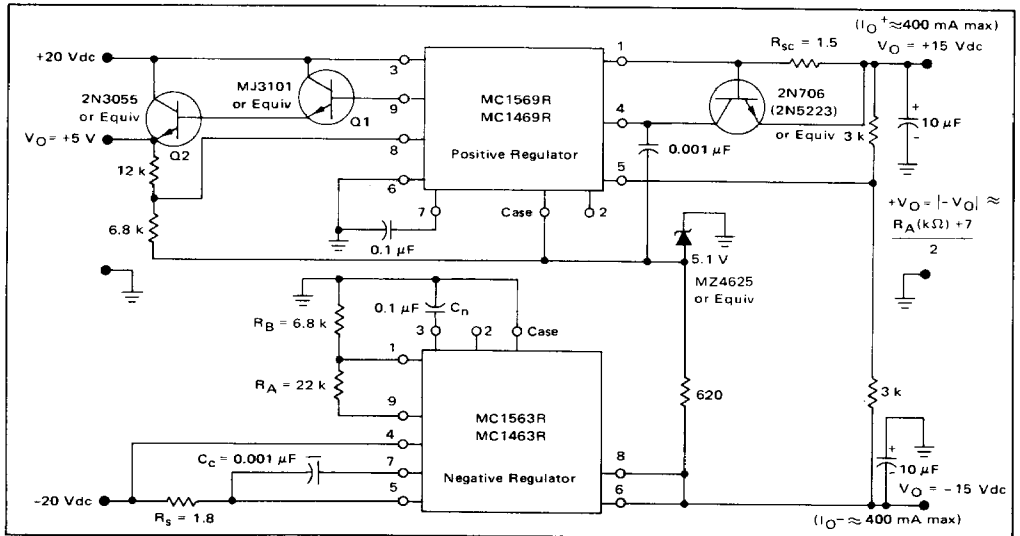
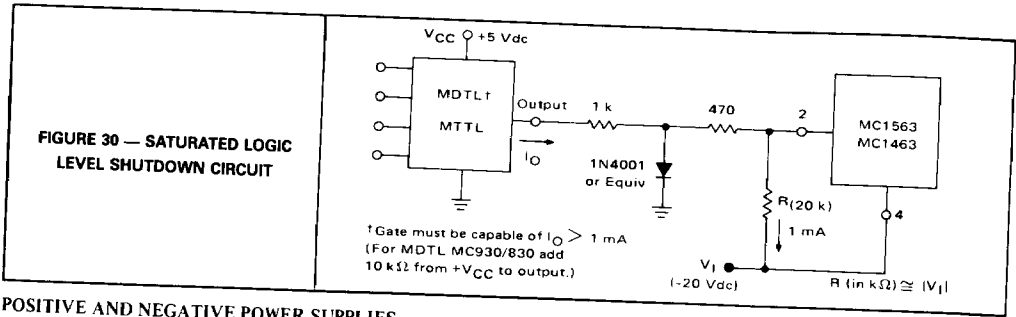

FIGURE 29 — A $\pm 15 \text{ Vdc}$ COMPLEMENTARY TRACKING REGULATOR WITH AUXILIARY $+5.0 \text{ V}$ SUPPLY



POSITIVE AND NEGATIVE POWER SUPPLIES

If the MC1563 is driven from a floating source it is possible to use it as a positive regulator by grounding the negative output terminal. The MC1563 may also be used with the MC1569 to provide completely independent positive and negative power regulators with comparable performance. When used in this manner a silicon diode such as the 1N4001 must be connected as a clamp on the output with the cathode to ground and the anode to the negative output voltage. This is to prevent the positive voltage in the system from forcing the output to a positive value and preventing the MC1563 from starting up.

Some applications may require complementary tracking in which both supplies arrive at the voltage level simultaneously, and variations in the magnitudes of the two voltages track. Figures 3 and 29 illustrate this approach. In this application, the MC1563 is used as the reference regulator, establishing the negative output voltage. The MC1569 positive regulator is used in a tracking mode by grounding one side of the differential amplifier (Pin 6 of the MC1569) and using the other side (Pin 5 of the MC1569) to sense the voltage developed at the junction of the two 3 k-ohm resistors. This differential amplifier controls the MC1569 series pass transistor such that the voltage at Pin 5 will be zero. When the voltage at pin 5 equals zero, +|V_O| must equal -|V_O|.

For the configuration shown in Figure 29, the level shift amplifier in the MC1569 is employed to generate an auxiliary +5-volt supply which is boosted to a 2-ampere capability by Q1 and Q2. (The +5-volt supply, as shown,

is not short-circuit protected.) The -15-volt supply varies less than 0.1 mV over a zero to -300 mAdc current range and the +15-volt supply tracks this variation. The +15-volt supply varies 20 mV over the zero to +300-mAdc load current range. The +5-volt supply varies less than 5 mV for $0 \leq I_L \leq 200$ mA with the other two voltages remaining unchanged. See MC1561 data sheet or MC1569 data sheet for information concerning latch-up when using plus and minus regulations.

SHUTDOWN TECHNIQUES

Pin 2 of the MC1563 is provided for the express purpose of shutting the regulator "OFF". Referring to the schematic, it can be seen that pin 2 goes to the base of a PNP transistor; which, if turned "ON", will deny current to all the biasing current sources. This action causes the output to go to essentially zero volts and the only current drawn by the IC regulator will be the small start current through the 60 k-ohm start resistor ($V_{in}/60\text{ k}\Omega$). This feature provides additional versatility in the applications of the MC1563. Various sub-systems may be placed in a "standby" mode to conserve power until actually needed. Or the power may be turned "OFF" in response to other occurrences such as over-heating, over-voltage, shorted output, etc.

As an illustration of the first case, consider a system consisting of both positive-supply logic (MTTL) and negative-supply logic (MECL). The MECL logic may be used in a high-speed arithmetic processor whose services are not continuously required. Substantial power may

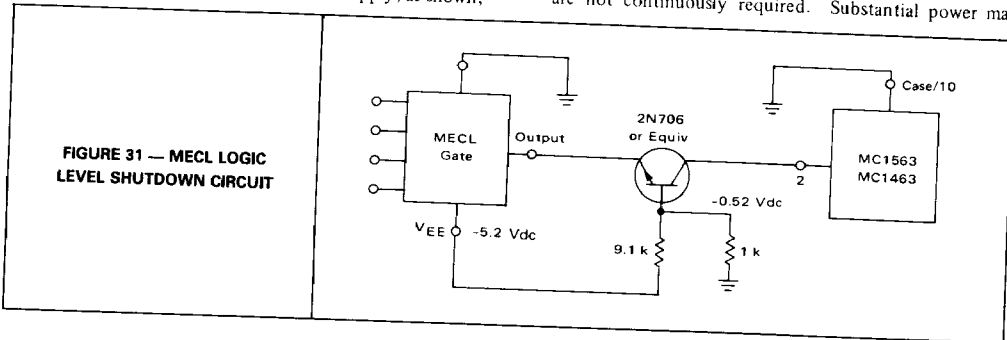

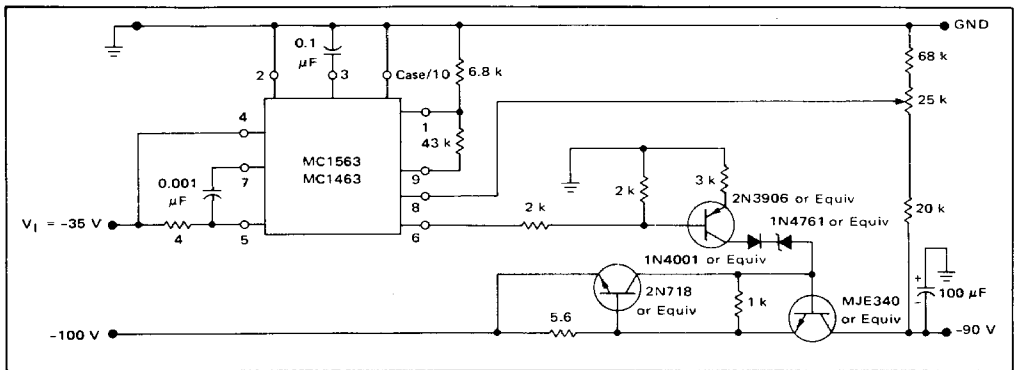

FIGURE 32 — VOLTAGE BOOSTING CIRCUIT

thus be conserved if the MECL circuitry remains unpowered except when needed. The negative regulator can be shutdown using any of the standard logic swings. For saturated logic control, Figure 30 shows a circuit that allows the normal positive output swing to cause the regulator to shutdown when the logic output is in the low voltage state. The negative output levels of a MECL gate can also be used for shutdown control as shown in Figure 31.

VOLTAGE BOOSTING

Some applications may require a high output voltage which may exceed the voltage rating of the MC1563. This must be solved by assuring that the IC regulator is operated within its limits. Three points in the regulator need to be considered:

1. The input voltage (Pin 4).
2. the output voltage (Pin 6) and,
3. the output sense lead (Pin 8).

A reduced input voltage can be provided by using a separate supply. The output voltage may be zener-level shifted, and the sense line can tie to a portion of the output voltage through a resistive divider. The voltage boost circuit of Figure 32 uses this approach to provide a -90 volt supply. This circuit will exhibit regulation of 0.001% over a 100 mA load current range.

REMOTE SENSING

The MC1563 offers a remote sensing capability. This is important when the load is remote from the regulator, as the resistances of the interconnecting lines (VEE and GND) are added directly to the output impedance of the regulator. By remote sensing, this resistance is included inside the control loop of the regulator and is essentially eliminated. Figure 33 shows how remote sensing is accomplished using both a separate sense line from Pin 8 and a separate ground line from the regulator to the remote load.

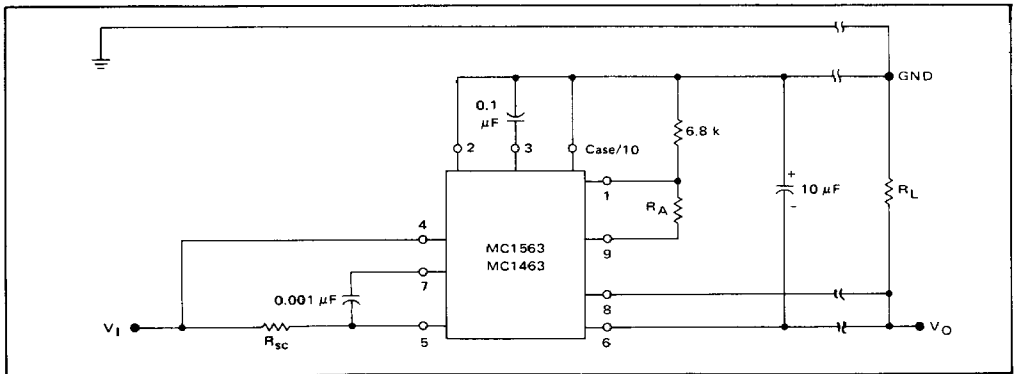

FIGURE 33 — REMOTE SENSING CIRCUIT

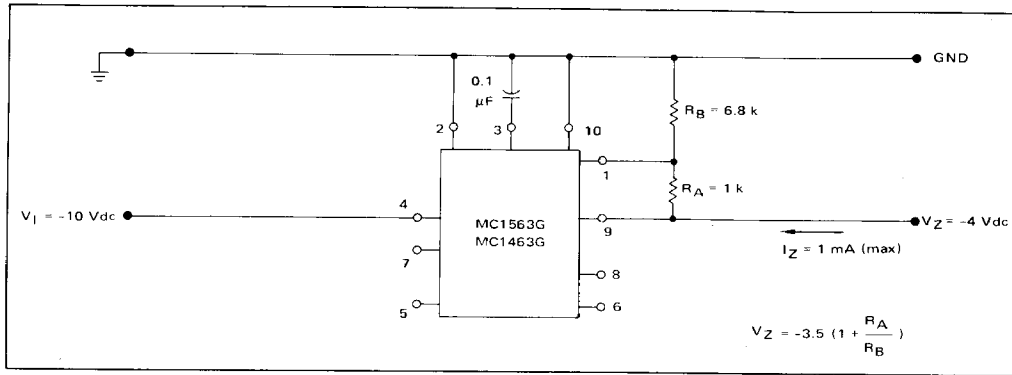

FIGURE 34 — AN ADJUSTABLE "ZERO-TC" VOLTAGE SOURCE

AN ADJUSTABLE ZERO-TEMPERATURE-COEFFICIENT (0-TC) VOLTAGE REFERENCE SOURCE

The MC1563, when used in conjunction with low-TC resistors, makes an excellent reference-voltage generator. If the -3.5 volt reference voltage of the IC regulator is a satisfactory value, then Pins 1 and 9 can be tied together and no resistors are needed. This will provide a voltage reference having a typical temperature coefficient of 0.002%/°C. By adding two resistors, R_A and R_B, any voltage between -3.5 Vdc and -37 Vdc can be obtained with the same low TC (see Figure 34)

THERMAL SHUTDOWN

By setting a fixed voltage at Pin 2, the MC1563 chip can be protected against excessive junction temperatures caused by power dissipation in the IC regulator. This is based on the negative temperature coefficient of the base-emitter junction of the shutdown transistor (-1.9 x

10⁻³V/°C). By setting -0.61 Vdc externally, at Pin 2, the regulator will shutdown when the chip temperature reaches approximately 140°C. Figure 35 shows a circuit that uses a zero-TC zener diode and a resistive divider to obtain this voltage.

In the case where an external pass transistor is employed; its temperature, rather than that of the IC regulator, requires control. A technique similar to the one just discussed can be used by directly monitoring the case temperature of the pass transistor as is indicated in Figure 36. The case of the normally "OFF" thermal monitoring transistor, Q2, should be in thermal contact with, but electrically isolated from, the case of the boost transistor, Q1.

THERMAL CONSIDERATIONS

Monolithic voltage regulators are subjected to internal heating similar to a power transistor. Since the degree of internal heating is a function of the specific application,

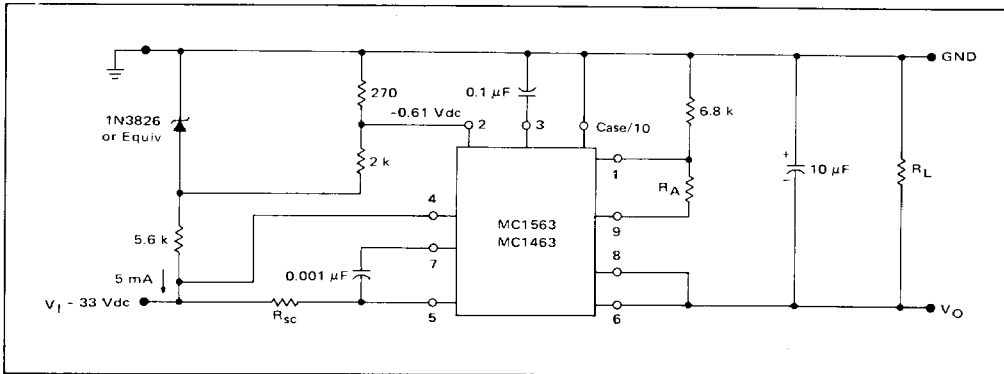

FIGURE 35 — JUNCTION TEMPERATURE LIMITING SHUTDOWN CIRCUIT

4

the designer must use caution not to exceed the specified maximum junction temperature (+175°C). Exceeding this limit will reduce reliability at an exponential rate. Good heatsinking not only reduces the junction temperature for a given power dissipation; it also tends to improve the dc stability of the output voltage by reducing the junction temperature change resulting from a change in the power dissipation of the IC regulator. By using the derating factors or thermal resistance values given in the Maximum Ratings Table of this data sheet, junction temperature can be computed for any given application in the same manner as for a power transistor*. A short-circuit on the output terminal can produce a "worst-case" thermal condition especially if the maximum input voltage is applied simultaneously with the maximum value of short-circuit load current (500 mA). Care should be taken not to exceed the maximum junction temperature rating during this fault condition and, in addition, the dc safe operating area limit (see Figure 22).

Thermal characteristics for a voltage regulator are useful in predicting performance since dc load and line regulation are affected by changes in junction temperature. These temperature changes can result from either a change in the ambient temperature, T_A , or a change in the power dissipated in the IC regulator. The effects of ambient

*For more detailed information of methods used to compute junction temperature, see Motorola Application Note AN-226, Measurement of Thermal Properties of Semiconductors.

temperature change on the dc output voltage can be estimated from the "Temperature Coefficient of Output Voltage" characteristic parameter shown as $\pm 0.002\%/^{\circ}\text{C}$, typical. Power dissipation is typically changed in the IC regulator by varying the dc load current. To estimate the dc change in output voltage due to a change in the dc load current, three effects must be considered:

1. junction temperature change due to the change in the power dissipation
2. output voltage decrease due to the finite output impedance of the control amplifier
3. thermal gradient on the IC chip.

A temperature differential does exist across a power IC chip and can cause a dc shift in the output voltage. A "gradient coefficient," GC_{V_O} , can be used to describe this effect and is typically $+0.03\%/watt$ for the MC1563R. For an example of the relative magnitudes of these effects, consider the following conditions:

- Given: MC1563R
 with $V_I = -10\text{ Vdc}$
 $V_O = -5\text{ Vdc}$
 and $I_L = 100\text{ mA to } 200\text{ mA}$
 $(\Delta I_L = 100\text{ mA})$
 assume $T_A = +25^{\circ}\text{C}$
 TO-66 Type Case with heatsink

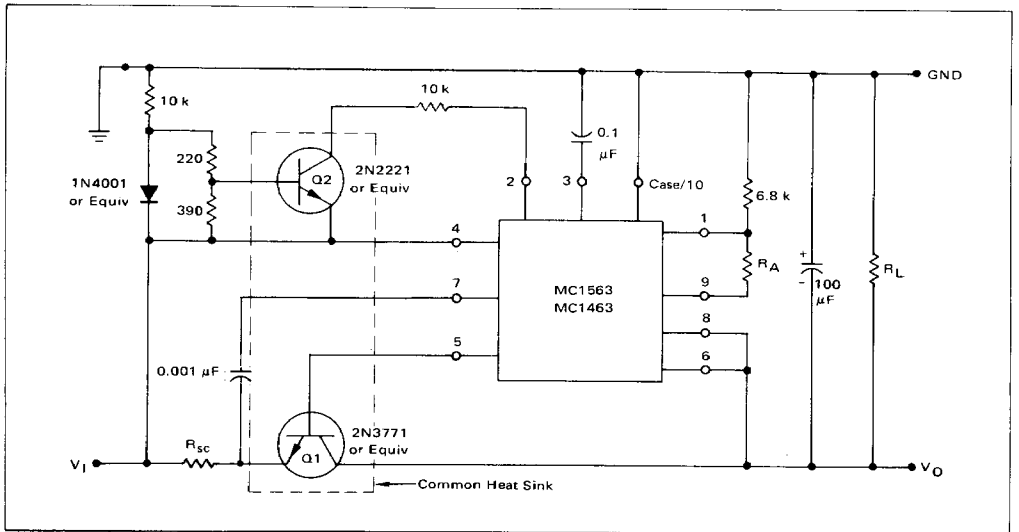

FIGURE 36 — THERMAL SHUTDOWN WHEN USING EXTERNAL PASS TRANSISTORS

assume $R_{\theta CS} = 0.2^{\circ}\text{C/W}$

and $R_{\theta SA} = 2^{\circ}\text{C/W}$

It is desired to find the ΔV_O which results from this ΔI_L . Each of the three previously stated effects on V_O can now be separately considered.

1. ΔV_O due to ΔT_J

OR $\Delta V_O = (V_O)(\Delta P_D)(\Delta V_O/\Delta T)(R_{\theta JC} + R_{\theta CS} + R_{\theta SA})$

$\Delta V_O = (5\text{ V})(5\text{ V} \times 0.1\text{ A})(\pm 0.002\%/^{\circ}\text{C})(19.2^{\circ}\text{C/W})$

$\Delta V_O \approx \pm 1.0\text{ mV}$

2. ΔV_O due to z_o

$|\Delta V_O| = (-z_o)(I_L)$

$|\Delta V_O| = -(2 \times 10^{-2})(10^{-1}) = -2\text{ mV}$

3. ΔV_O due to gradient coefficient, $\Delta V_O/\Delta G$

$|\Delta V_O| = (\Delta V_O/\Delta G)(V_O)(\Delta P_D)$

$|\Delta V_O| = (+3 \times 10^{-4}/\text{W})(5\text{ volts})(5 \times 10^{-1}\text{ W})$

$|\Delta V_O| = +0.8\text{ mV}$

Therefore the total ΔV_O is given by

OR $|\Delta V_O\text{ total}| = \pm 1.0 - 2.0 + 0.8\text{ mV}$

$-2.2\text{ mV} \leq |V_O\text{ total}| \leq -0.2\text{ mV}$

Other operating conditions may be substituted and computed in a similar manner to evaluate the relative effects of the parameters.

TYPICAL PRINTED CIRCUIT BOARD LAYOUT

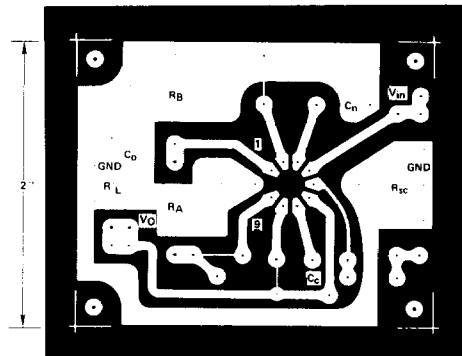

4

FIGURE 37 — LOCATION OF COMPONENTS

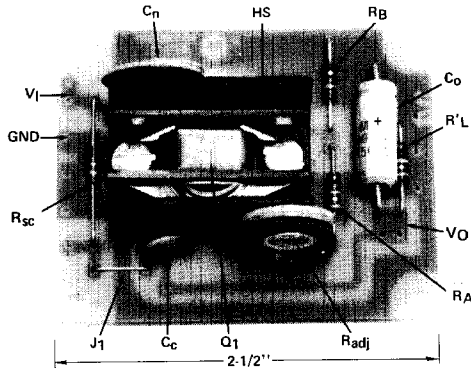

Note 1:

When R_{adj} is used it is necessary to remove the copper which shorts out R_{adj} .

Note 2:

Extra holes are available in the circuit board to permit two resistors to be paralleled to obtain the desired value of R_{sc} .

Note 3:

If Pin 2 is used to shut down the regulator, remove the copper which shorts Pin 2 to ground.

Note 4:

Remote sensing can be achieved by removing the copper which shorts Pin 8 to Pin 6 and connecting Pin 8 directly to the "minus" load terminal. The circuit board ground should be connected to the unregulated power supply ground at the "plus" load terminal.

TYPICAL CIRCUIT CONNECTION FOR OUTPUT VOLTAGES BETWEEN -3.5 AND -37 VOLTS

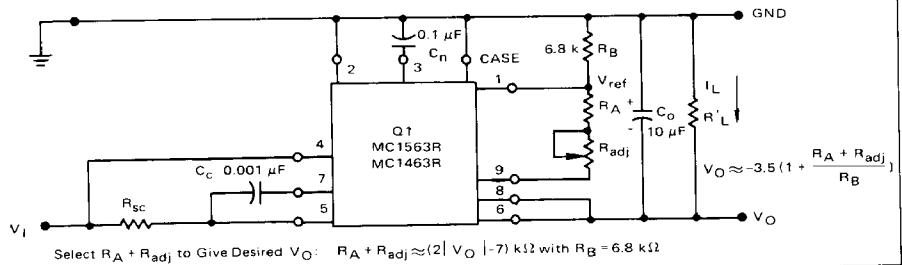

PARTS LIST

Component	Value	Description
R_A	Select	1/4 or 1/2 watt carbon
R_B	6.8 k	
R_{adj}	Select	IRC Model X-201, Mallory Model MTC-1 or equivalent
R_{sc}	Select	1/2 watt carbon
$R'L$	Select	For minimum current of 1 mA dc
C_o	10 μF	Sprague 1500 Series, Dickson D10C series or equivalent
C_n	0.1 μF	Ceramic Disc — Centralab DDA104, or equivalent
C_c	0.001 μF	
J_1		Jumper
Q1		MC1563R or MC1463R
*HS		Heatsink Thermalloy #6168 B or equivalent
*Socket	(Not Shown)	Robinson Nugent #0001306 or equivalent Electronic Molding Corp. #6341-210-1, 6348-188-1, 6349-188-1 or equivalent
PC Board		Circuit DOT, Inc. #PC1113 or equivalent 1155 W. 23rd St. Tempe, Arizona 85281

*Optional