



10/100Mbps Ethernet Fiber and Copper Media Converter with Auto-Negotiation

GENERAL DESCRIPTION

The ML6652 is a low cost multi-function / multi-standard single chip Media Converter that provides 10Mbps and 100Mbps signal conversion between twisted pair and fiber optic Ethernet technologies. The device supports conversion between:

10BASE-T and 10BASE-FL
100BASE-TX and 100BASE-FX/SX
100BASE-FX and 100BASE-SX
FLP Bursts and FLNP Bursts

The device supports 10Mbps and 100Mbps operating data rates with Auto-Negotiation using 850nm or 1300nm optics. One or both of the fiber optic and twisted pair interfaces can be interfaced to industry standard miniature fiber optic components or Physical Media Dependent (PMD) modules using Positive Emitter Coupled Logic/Low Voltage Positive Emitter Coupled Logic (PECL/LVPECL) compatible modes. Support of other wavelengths is possible using the PECL/LVPECL interface.

APPLICATIONS

- Single/Multi Port 10/100 Auto-Negotiating Media Converters
- Single/Multi Port 100BASE-FX/SX to 100BASE-TX Media Converters
- Single/Multi Port 10BASE-FL to 10BASE-T Media Converters
- Single/Multi Mode Fiber Converters
- Fiber Optic Front-End for Network Interface Cards (NICs), Repeaters, Bridges, Hubs and Switches
- Fiber-To-The-Desk/Building/Factory Floor as well as Home Connectivity Gateway/Demarcation Products
- Redundant Link Converters and Wavelength Converters

FEATURES

- Complete implementation of fiber optic and twisted pair media interface
- Supports ISO/IEC 8802.3, IEEE 802.3 and TIA/EIA-785 Industry Standards, including full Auto-Negotiation for twisted pair and fiber optic media
- 850nm, 1300nm miniature fiber optic components and PMD modules
- Supports 1:1 receiver/transmitter transformer ratio for twisted pair
- Low latency
- Integrated voltage and current references
- Integrated twisted pair output wave shaping eliminates external filtering
- Integrated twisted pair 10BASE-T input filter and 100BASE-TX equalizer with baseline wander correction circuit
- Serial Management Interface
- Full and Half Duplex with Auto-Negotiation
- Integrated LED Driver
- Integrated Data Quantizer
- Small 44-Pin TQFP and LPCC/QFN
- Low 3.3V power supply
- Integrated Link Integrity Warning (LIW)

TABLE OF CONTENTS

General Description 1

Features 1

Applications 1

Warranty Information 2

Block Diagram 3

Pin Configuration 4

Pin Descriptions 4

General Description 13

Functional Description 14

Device Configuration 14

Default Power Configuration 14

Serial Management Interface 14

Speed Selection 15

Operating Modes 16

Transparent Mode 18

Fiber Optic Input/Output Interface 18

Power Down Mode 19

Loopback Mode 19

Scrambler/Descrambler 19

Output Off Mode 19

Backup Link Mode 19

LED Interface 20

Control Registers 21

Status Registers 23

Electrical Characteristics 24

Physical Dimensions 28

Order Information 28

WARRANTY

Micro Linear makes no representations or warranties with respect to the accuracy, utility, or completeness of the contents of this publication and reserves the right to make changes to specifications and product descriptions at any time without notice. No license, express or implied, by estoppel or otherwise, to any patents or other intellectual property rights is granted by this document. The circuits contained in this document are offered as possible applications only. Particular uses or applications may invalidate some of the specifications and/or product descriptions contained herein. The customer is urged to perform its own engineering review before deciding on a particular application. Micro Linear assumes no liability whatsoever, and disclaims any express or implied warranty, relating to sale and/or use of Micro Linear products including liability or warranties relating to merchantability, fitness for a particular purpose, or infringement of any intellectual property right. Micro Linear products are not designed for use in medical, life saving, or life sustaining applications. If this document is "Advance", its contents describe a Micro Linear product that is currently under development. All detailed specifications including pinouts and electrical specifications may be changed without notice. If this document is "Preliminary", its contents are based on early silicon measurements. Typical data is representative of the product but is subject to change without notice. Pinout and mechanical dimensions are final. Preliminary documents supersede all Advance documents and all previous Preliminary versions. If this document is "Final", its contents are based on a characterized product, and it is believed to be accurate at the time of publication. Final Data Sheets supersede all previously published versions. This document is Final.

© 2004 Micro Linear Corporation. All rights reserved. All other trademarks are the property of their respective owners.

Products described herein may be covered by one or more of the following U.S. patents: 4,897,611; 4,964,026; 5,027,116; 5,281,862; 5,283,483; 5,418,502; 5,508,570; 5,510,727; 5,523,940; 5,546,017; 5,559,470; 5,565,761; 5,592,128; 5,594,376; 5,652,479; 5,661,427; 5,663,874; 5,672,959; 5,689,167; 5,714,897; 5,717,798; 5,742,151; 5,747,977; 5,754,012; 5,757,174; 5,767,653; 5,777,514; 5,793,168; 5,798,635; 5,804,950; 5,808,455; 5,811,999; 5,818,207; 5,818,669; 5,825,165; 5,825,223; 5,838,723; 5,844,378; 5,844,941. Japan: 2,598,946; 2,619,299; 2,704,176; 2,821,714. Other patents are pending.

BLOCK DIAGRAM

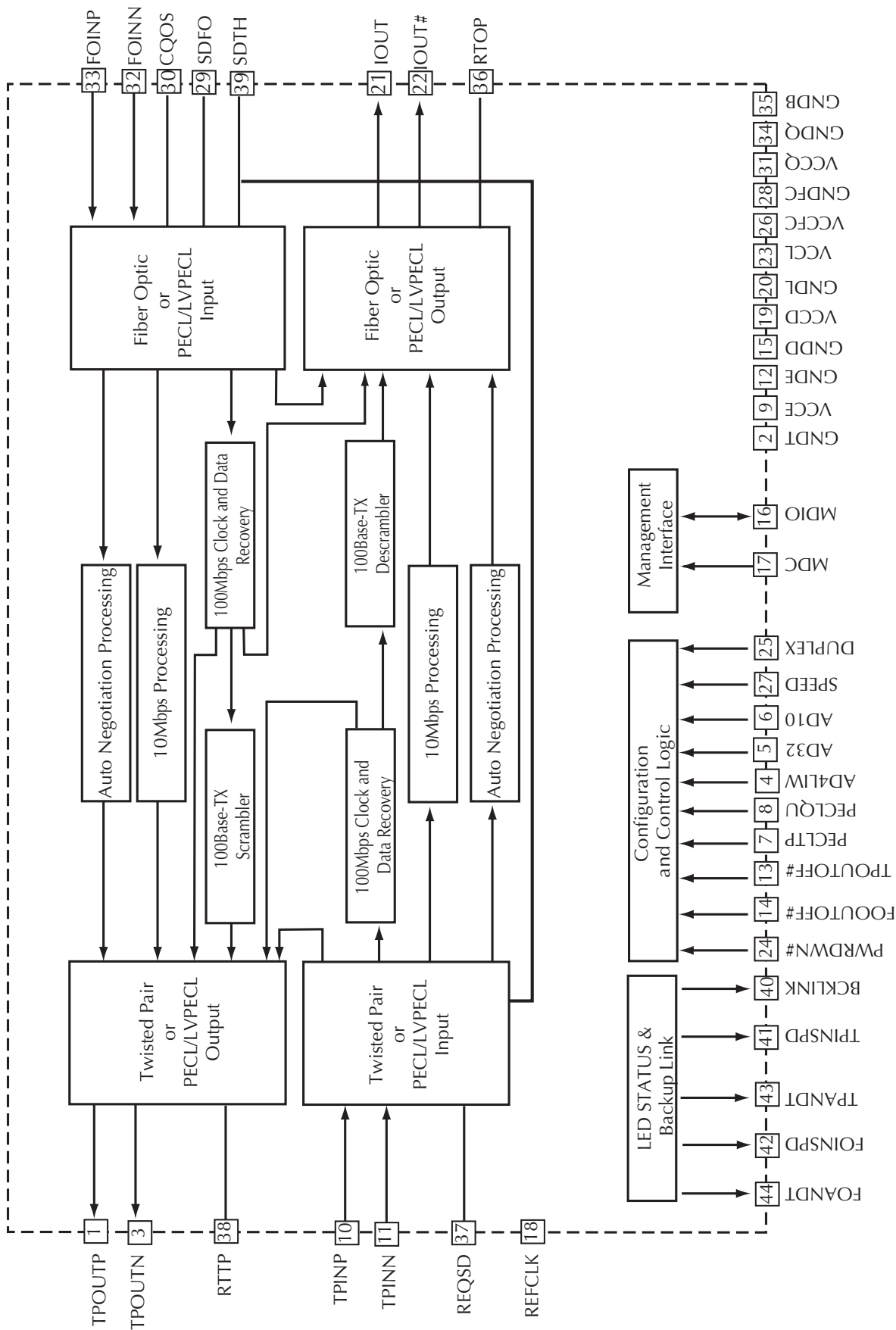

PIN CONFIGURATION

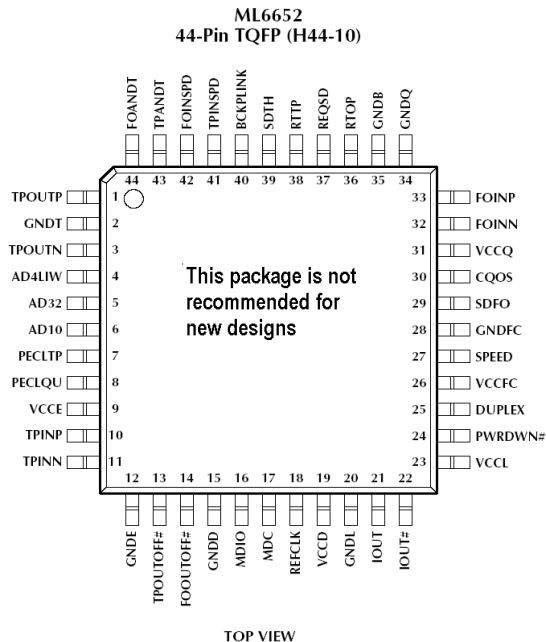
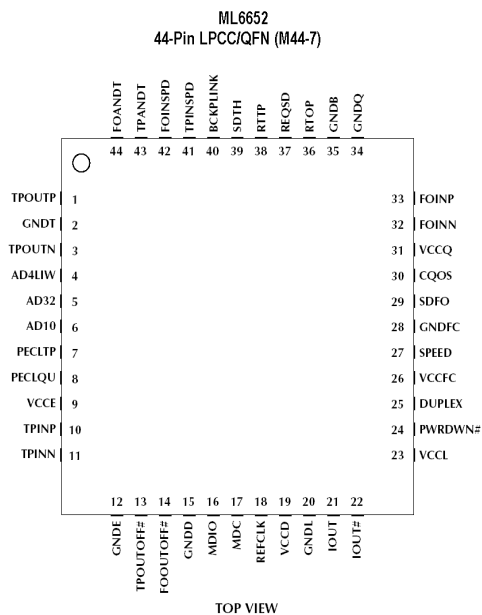

PIN DESCRIPTIONS

Signal names followed by "#" indicate active low input.

Pin No.	Signal Name	I/O	Description
---------	-------------	-----	-------------

CONFIGURATION

4	AD4LIW	I	<p>Sets the value of the Physical Layer (PHY) address bit 4 for accessing the Serial Management Interface, and determines if the Link Integrity Warning (LIW) function is enabled or disabled.</p> <p>The Link Integrity Warning (LIW) function can only be enabled when only one SPEED is available through setting of SPEED (pin 27) and/or management registers. When LIW is enabled and the input link is down at one interface to the Media Converter, the transmitter output on that interface is turned off for about 425ms every 3.8 seconds. It applies to both network interfaces and both data rates. If the link at the other interface to the Media Converter is also down, there is no output. The LIW function causes the Link Up indicator of the link partner to blink.</p> <p>Note: this pin is typically read a few microseconds after power-up, if it is tied to supplies that do not track the ML6652 power improper results will occur. Use VCCD (pin 19) as the pull up point, do not add decoupling capacitors to this input pin (without thoroughly understanding your PCB layout dynamics the safest course is to make short connections and do not add decoupling capacitors to this input pin).</p>
5	AD32	I	<p>Sets the value of the PHY address bits 3 and 2 for accessing the Serial Management Interface.</p> <p>Note: this pin is typically read a few microseconds after power-up, if it is tied to supplies that do not track the ML6652 power improper results will occur. Use VCCD (pin 19) as the pull up point, do not add decoupling capacitors to this input pin (without thoroughly understanding your PCB layout dynamics the safest course is to make short connections and do not add decoupling capacitors to this input pin).</p>

PIN DESCRIPTIONS (continued)

Pin No.	Signal Name	I/O	Description
6	AD10	I	<p>Sets the value of the PHY address bits 1 and 0 for accessing the Serial Management Interface.</p> <p>Note: this pin is typically read a few microseconds after power-up, if it is tied to supplies that do not track the ML6652 power improper results will occur. Use VCCD (pin 19) as the pull up point, do not add decoupling capacitors to this input pin (without thoroughly understanding your PCB layout dynamics the safest course is to make short connections and do not add decoupling capacitors to this input pin).</p>

Pin Name	AD4LIW		AD32		AD10	
	LIW Function	PHYAD4 Bit	PHYAD3 Bit	PHYAD2 Bit	PHYAD1 Bit	PHYAD0 Bit
Input Level	0	Disabled	0	0	0	0
1/3 of VCC	1	Enabled	1	0	1	0
2/3 of VCC	1	Enabled	1	1	1	1
VCC	1	Disabled	0	1	0	1

Table 1.

Pin No.	Signal Name	I/O	Description
7	PECLTP	I	<p>The copper interface is selected as shown in Table 2. When twisted pair interface is selected, the scrambler and descrambler are enabled by default and can be disabled with a management register bit.</p> <p>When using twisted pair interface, this pin also defines the maximum supported link distance. When the 10 meters maximum link length is selected, the input is not equalized before being sliced.</p> <p>Note: this pin is typically read a few microseconds after power-up, if it is tied to supplies that do not track the ML6652 power improper results will occur. Use VCCD (pin 19) as the pull up point, do not add decoupling capacitors to this input pin (without thoroughly understanding your PCB layout dynamics the safest course is to make short connections and do not add decoupling capacitors to this input pin).</p>

PECLTP Voltage	Interfaces at TPINP/TPINN and TPOUTP/TPOUTN	PECLTP <30.3> Default	Copper Length	SHORTTP <30.2> Default	Output Current	LOWITPOUT <30.4> Default
0	Twisted Pair	0	100BASE-TX Standard	0	Standard	0
1/3 of VCC	PECL/LVPECL	1	PCB Traces	0	NA	0
2/3 of VCC	Twisted Pair	0	PCB Traces	1	Low	1
VCC	Twisted Pair	0	10m	1	Standard	0

Table 2.

PIN DESCRIPTIONS (continued)

Pin No.	Signal Name	I/O	Description
8	PECLQU	I	The fiber interface is selected as shown in Table 3. When using an LED driver and fiber optic receiver, this pin also defines the maximum supported link distance. When the 300m maximum link length is selected, the voltage thresholds for Signal Detect are increased.

PECLQU Voltage	Interfaces at FOINP/FOINN and IOUT/IOUT#	PECLQU <30.7> Default	Fiber Optic Link Length 10BASE/100BASE	SHORTFO <30.5> Default	Wavelength	LONGWL <30.6> Default
0	Quantizer and LED Driver	0	2Km/300m	0	850nm	0
1/3 of VCC	PECL/LVPECL	1	PCB Traces	0	NA	0
2/3 of VCC	Quantizer and LED Driver	0	2Km/2Km	0	1300nm	1
VCC	Quantizer and LED Driver	0	300m/300m	1	850/1300nm	0

Table 3.

Note: The ML6652 fiber interface quantizer sensitivity can be adjusted via Register 30 bits 5, 6 and 7 to accomodate various cable lengths and signal intensity.

Pin No.	Signal Name	I/O	Description
25	DUPLEX	I	This input can have one of three levels: VCC, VCC/2 or 0 Volts. This input has 80kΩ resistors internally connected to both VCC and Ground, generating VCC/2 at the input if left unconnected. Settings defined by the DUPLEX power up preset pin can be over written by the management interface. At power up the DUPLEX pin causes the following default values to be written to management register 30. Note: this pin is typically read a few microseconds after power-up, if it is tied to supplies that do not track the ML6652 power improper results will occur. Use VCCD (pin 19) as the pull up point, do not add decoupling capacitors to this input pin (without thoroughly understanding your PCB layout dynamics the safest course is to make short connections and do not add decoupling capacitors to this input pin).

DUPLEX Voltage	TRANSPARENT# <30.11> Default	ADVERTFD# <30.10> Default	ADVERTHD# <30.15> Default
0	1	1	0
VCC/2	0	0	0
VCC	1	0	0

Table 4.

PIN DESCRIPTIONS (continued)

Pin No.	Signal Name	I/O	Description
---------	-------------	-----	-------------

DUPLEX and SPEED can be used concurrently to set the power up mode of the ML6652 see Tables 4 and 6. For Mode details see the General Description section of this data sheet.

27	SPEED	I	This input can have one of three levels: VCC, VCC/2, and 0Volts. The input has 80kΩ resistors internally connected to both VCC and Ground generating VCC/2 at the input, if left unconnected. Settings defined by the SPEED power up preset pin can be over written by the management interface. At power up the SPEED pin causes the following default values to be written to management register 30.
----	-------	---	---

Note: this pin is typically read a few microseconds after power-up. If it is tied to supplies that do not track the ML6652 power, improper results will occur. Use VCCD (pin 19) as the pull up point, do not add decoupling capacitors to this input pin (without thoroughly understanding your PCB layout dynamics the safest course is to make short connections and do not add decoupling capacitors to this input pin).

SPEED Voltage	DSBLAN <30.14> Default	SINGLESPEED <30.9> Default	SEL10Mbps <30.8> Default
0	1	1	1
VCC/2	0	0	0
VCC	1	1	0

Table 5.

Mode	Operating Summary	SPEED Voltage	DUPLEX Voltage
Forced 10	10Mbps data rate only available. The Duplex mode is selected by the link partner.	0	N/A
Forced 100	100Mbps data rate only available. The Duplex mode is selected by the link partner.	VCC	N/A
Non-Transparent Half-Duplex	Only the Half-Duplex mode is advertised. Both 10 and 100Mbps data rates are available. Only the data rate equivalent to the technology present at the fiber optic input interface is advertised.	VCC/2	0
Non-Transparent	FLP Bursts are generated. Both HalfDuplex and Full-Duplex modes are advertised. Both 10 and 100Mbps data rates are available. Only the data rate equivalent to the technology present at the fiber optic input interface is advertised.	VCC/2	VCC
Transparent	Standard Auto-Negotiation sub-layer 10Mbps, 100Mbps and Auto-Negotiation far end link partner signaling available.	VCC/2	VCC/2

Table 6.

PIN DESCRIPTIONS (continued)

Pin No.	Signal Name	I/O	Description
CONTROL			
13	TPOUTOFF#	I (CMOS)	Active low, the output stage of the twisted pair output is turned off. Contains an on-chip 80k Ω pull-up resistor.
14	FOOUTOFF#	I (CMOS)	Active low, the output stage of the fiber optic output is turned off. Contains an on-chip 80k Ω pull-up resistor.
24	PWRDWN#	I (CMOS)	Active low, all the circuits are powered down. Configuration pins are read and register bits are initialized 5 μ s (typ) after a rising edge of PWRDWN#. Contains an on-chip 80k Ω pull-up resistor.
DATA SIGNAL INPUT/OUTPUT			
1	TPOUTP	O	The two operating modes available for these pins are selected with the configuration pin PECLTP (pin 7) or the configuration bit PECLTP <30.3>
3	TPOUTN	O	<p>Twisted Pair Interface Mode: Transmit twisted pair positive and complementary outputs. These outputs form a differential current output pair that drives Multi Level Transition (MLT-3) waveforms into the network coupling transformer during 100Mbps mode, Manchester encoded 10BASE-T data or Normal Link Pulses (NLPs) during 10Mbps mode, and Fast Link Pulse (FLP) Bursts during Auto-Negotiation. TPOUTP and TPOUTN must have external pull up resistors to VCC (refer to description of RTTP pin)</p> <p>PECL/LVPECL Compatible Interface Mode: PECL/LVPECL interface positive and complementary outputs. These outputs form a differential current output pair that drives Non Return to Zero Inverted (NRZI) encoded 100BASE-FX or 100BASE-SX symbols during 100Mbps mode, Manchester encoded 10BASE-FL data or OPT_IDL during 10Mbps mode, and Fiber Link Negotiation Pulse (FLNP) Bursts during Auto-Negotiation. TPOUTP and TPOUTN must have external pull up resistors to VCC and be AC coupled to the inputs of a fiber optic PMD module (refer to description of RTTP pin). A resistor network may be needed to setup the common mode voltage at the input pins of the PMD module</p>
38	RTTP	I	<p>Twisted pair PECL/LVPECL compatible driver bias resistor. An external resistor connected between RTTP and ground sets a constant bias current for the differential output driver circuitry TPOUTP/TPOUTN. These output currents depend on the operating mode. The recommended external component values are:</p> <p>Twisted Pair Mode: 2kΩ, 1%, between RTTP and ground 50Ω, 1%, between TPOUTP and VCC 50Ω, 1%, between TPOUTN and VCC</p> <p>PECL Compatible mode: 2kΩ, 1%, between RTTP and ground Equivalent 62Ω between TPOUTP and VCC Equivalent 62Ω between TPOUTN and VCC Also AC coupled to the PMD inputs</p>
10	TPINP	I	The two operating modes available for these pins are selected with the configuration pin PECLTP (Pin 7) or the configuration bit PECLTP <30.3>.
11	TPINN	I	<p>Twisted Pair Interface Mode: Receive twisted pair positive and complementary inputs. These inputs form a differential input pair that receives 100BASE-TX, FLP Burst, or 10BASE-T signal from the network. The common mode voltage is set internally and the differential input resistance is about 2kΩ. The network termination must be added externally. It should contain a 100Ω resistor between pin 10 and 11 as shown in Figure 1.</p>

PIN DESCRIPTIONS (continued)

Pin No.	Signal Name	I/O	Description
---------	-------------	-----	-------------

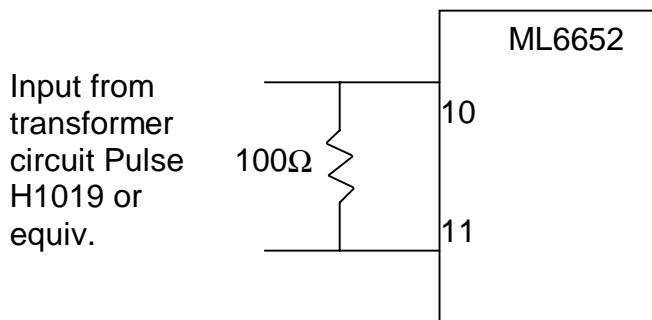

Figure 1. Twisted Pair Interface Mode Input Networks

PECL/LVPECL Compatible Interface Mode:

PECL/LVPECL compatible interface positive and complementary inputs. These inputs form a differential input pair that receives 100BASE-FX, 100BASE-SX, FLNP Bursts, or 10BASE-FL signal from a fiber optic PMD. The PMD outputs should be AC coupled to these inputs with .1μF capacitors. The common mode voltage is set internally with ~1kΩ or so resistors from each input pin to an on-chip voltage reference. The positive output of the PMD (high during the high-light state) must connect to TPINP and the complementary output of the PMD must connect to TPINN

37	REQSD	I	<p>The two operating modes available for this pin are selected with the configuration pin PECLTP or the configuration bit PECLTP <30.3></p> <p>Twisted Pair Interface Mode: Equalizer bias resistor pin. An external resistor connected between this pin and ground sets internal currents that control the receiver's adaptive equalizer transfer function. The recommended resistor value is 5kΩ, 1%</p> <p>PECL/LVPECL Compatible Interface Mode: This input pin is connected to the Signal Detect (SD) output of a fiber optic PMD module. The voltage level at this pin is compared to the voltage level at pin SDTH to determine the logic value. If it is lower, then the input at TPINP/TPINN is rejected. If it is higher, then the input at TPINP/TPINN is passed to the internal circuits</p>
39	SDTH	I	<p>The voltage at this pin is a single ended PECL/LVPECL reference. Refer to description of SDFO and REQSD pins. This pin is not used if the TPINP/TPINN interface and the FOINP/FOINN are not setup for PECL/LVPECL compatible mode. In such a case, the SDTH pin should be set to VCC</p>
21	IOUT	O	<p>The two operating modes available for these pins are selected with the configuration pin PECLQU or the configuration bit PECLQU <30.7></p>
22	IOUT#	O	<p>Fiber Optic Interface Mode: IOUT (pin 21) becomes the output connection to the cathode of an external fiber optic LED. The output data is NRZI encoded 100BASE-FX or 100BASE-SX symbols during 100Mbps mode, Manchester encoded 10BASE-FL data or OPT_IDL (10BASE-FL idle signal) during 10Mbps mode, and FLNP Bursts during Auto-Negotiation. IOUT# (pin 22) is optionally used to provide current peaking. If peaking is</p>

PIN DESCRIPTIONS (continued)

Pin No.	Signal Name	I/O	Description
			implemented, a 1k Ω off-chip resistor should be connected to ground and a 1nF capacitor connected to IOU T . These components determine the peaking current waveform. When peaking is not used, IOU T # should connect to VCC PECL/LVPECL Compatible Interface Mode: PECL/LVPECL interface positive and complementary outputs. These outputs form a differential current output pair that drives NRZI encoded 100BASE-SX or 100BASE-FX symbols during 100Mbps mode, Manchester encoded 10BASE-FL data or OPT_IDL during 10Mbps mode, and FLNP Bursts during Auto-Negotiation. IOU T and IOU T # are loaded with external resistors to VCC and AC coupled to the inputs of a fiber optic PMD module (refer to description of RTOP pin). A resistor network may be needed to setup the common mode voltage at the input pins of the PMD module
36	RTOP	O	Fiber optic LED or PECL/LVPECL driver bias resistor. An external resistor connected between RTOP and ground sets a constant bias current for the single ended LED driver or differential PECL/LVPECL driver circuitry. These output currents depend on the operating mode. The recommended external component values are: Fiber Optic Interface mode: (1% resistors, +/- 10% currents) Indicated is the current into pin IOU T during the High-Light state. 2.8k Ω between RTOP and ground for 50mA. 2k Ω between RTOP and ground for 70mA. 1.4k Ω between RTOP and ground for 100mA. PECL/LVPECL Interface mode: 1.4k Ω , 1%, between RTOP and ground for 10mA current. Equivalent 62 Ω between IOU T and VCC. Equivalent 62 Ω between IOU T # and VCC. Also AC coupled to PMD inputs
33	FOINP	I	The two operating modes available for these pins and are selected with the configuration pin PECLQU or the configuration bit PECLQU <30.7> Fiber Optic Interface Mode: Fiber optic quantizer positive and complementary inputs. FOINP is capacitively coupled to the output of a fiber optic receiver, while FOINN is capacitively coupled to the VCC of the fiber optic receiver. Recommended capacitor values: 10nF, 5%. FOINP voltage must be higher during the "high light" state than during the low-light state PECL/LVPECL Compatible Interface Mode: PECL/LVPECL interface positive and complementary inputs. These inputs form a differential input pair that receives 100BASE-FX, 100BASE-SX, FLNP Bursts, or 10BASE-FL signal from a fiber optic PMD. The PMD outputs are AC coupled to these inputs with 10nF, 5% capacitors. The common mode voltage is set internally with ~900 Ω (or so) resistors from each input pin to an on-chip voltage reference. FOINP voltage must be higher during the "high light" state than during the "low light" state
32	FOINN	I	
30	CQOS		Data quantizer offset cancellation loop capacitor. An external capacitor between this pin and VCC determines the dominant pole of the offset cancellation feedback loop. The recommended value is .1 μ F, 10%. It is only required in "Fiber Optic Interface" mode.
29	SDFO	I	The two operating modes available for this pin are selected with the configuration pin PECLQU or the configuration bit PECLQU <30.7> Fiber Optic Interface Mode: This pin is not used and should be connected to VCC.

PIN DESCRIPTIONS (continued)

Pin No.	Signal Name	I/O	Description
PECL/LVPECL Compatible Interface Mode:			
This input pin is connected to the Signal Detect (SD) output of a fiber optic PMD. The voltage level at this pin is compared to the voltage level at pin SDTH to determine the logic value. If it is lower than the input at FOINP/FOINN is rejected. If it is higher than the input at FOINP/FOINN is passed to the internal circuits.			
BACKUP LINK FUNCTION			
40	BCKPLINK	I/O	<p>INPUT MODE:</p> <p>At power up, pin 40 (BCKPLINK) is read and the BCKPDIS register <28.1> is set appropriately. A high (VCC) at power up causes Register 28, Bit 1 (BCKPDIS) to be set high (1) disabling the Back-up link function. BCKPDIS can subsequently be over written by the management interface at any time.</p> <p>Note: This pin is typically read a few microseconds after power-up, if it is tied to supplies that do not track the ML6652 power, improper results may occur. For BCKPLINK, use VCCD (pin 19) as the pull up point, do not add decoupling capacitors to Pin 40 (without thoroughly understanding your PCB layout power up dynamics the safest course is to make short connections and do not add decoupling capacitors to this pin).</p> <p>OUTPUT MODE:</p> <p>After power-up, BCKPLINK is used as an output. It is Active high to enable a secondary fiber link via a second ML6652 device (see Functional Description, Backup Link Mode in this data sheet for details).</p> <p>Use this function in forced 100Mbps mode, non loopback only</p>
LED STATUS			
41	TPINSPD	O	This output goes high to indicate that a 100Mbps signal is present at the TPINP/TPINN interface, and it goes low to indicate that a 10Mbps signal is present at the TPINP/TPINN interface. The signal can be idle or packets. This pin is set to high impedance otherwise.
42	FOINSPD	O	This output goes high to indicate that a 100Mbps signal is present at the FOINP/FOINN interface, and it goes low to indicate that a 10Mbps signal is present at the FOINP/FOINN interface. The signal can be idle or packets. This pin is set to high impedance otherwise.
43	TPANDT	O	When TPINSPD is in the high impedance state, no 10 or 100Mbps signal at TPINP/TPINN, the TPANDT LED pulls low while receiving Auto-Negotiation signal at the TPINP/TPINN interface. When TPINSPD is not in the high impedance state, the TPANDT pin pulls low to indicate that a data packet is being detected at the TPINP/TPINN interface. When a data packet is indicated, the pulse width at TPANDT is stretched to a minimum of 1.3 to 2.7ms to improve visibility. In any other case this pin is in high impedance state.

PIN DESCRIPTIONS (continued)

Pin No.	Signal Name	I/O	Description
LED STATUS (CONTINUED)			
44	FOANDT	O	When FOINSPD is in the high impedance state, no 10 or 100Mbps signal at FOINP/FOINN, the FOANDT LED pulls low while receiving Auto-Negotiation signal at the FOINP/FOINN interface. When FOINSPD is not in the high impedance state, the FOANDT pin pulls low to indicate that a data packet is being detected at the FOINP/FOINN interface. When a data packet is indicated, the pulse width at FOANDT is stretched to a minimum of 1.3 to 2.7ms to improve visibility. In any other case this pin is in high impedance state.
MANAGEMENT INTERFACE			
16	MDIO		Management data TTL compatible input/output pin. Connect to ground if unused
17	MDC		Management clock TTL input. The maximum frequency can be 12.5MHz instead of the 2.5MHz limit of IEEE 802.3. Connect to ground if unused
REFERENCE CLOCK			
18	REFCLK		25MHz Reference Clock CMOS input. This clock is used for internal digital logic, and as a reference for the PLLs.
POWER AND GROUND			
2	GNDT		Ground for the twisted pair driver output stage.
12	GNDE		Ground for the equalizer, one PLL and part of the descrambler and twisted pair driver.
15	GNDD		Ground for CMOS noisy circuits.
20	GNDL		Ground for the fiber optic LED driver output stage.
28	GNDFC		Ground for one PLL, part of the scrambler, fiber optic LED driver, and quantizer.
34	GNDQ		Ground for the quantizer and central bias.
35	GNDB		Ground for part of the central biasing.
9	VCCE		Power supply for the equalizer, one PLL and part of the descrambler and twisted pair driver.
19	VCCD		Power supply for CMOS noisy circuits.
23	VCCL		Power supply for the fiber optic LED driver output stage.
26	VCCFC		Power supply for one PLL, part of the scrambler, fiber optic LED driver, and quantizer.
31	VCCQ		Power supply for the quantizer and central bias.

GENERAL DESCRIPTION

The ML6652 Fast Ethernet Media Converter provides signal conversion between the following standards:

- 10BASE-T to 10BASE-FL; (10Mbps twisted pair copper media and 10Mbps 850nm fiber media)
- Proprietary 10BASE-T to 10BASE-1300nm Fiber; (10Mbps twisted pair copper media and 10Mbps 1300nm fiber media).
- 100BASE-TX to 100BASE-SX/FX (100Mbps twisted pair copper media and 1300nm or 850nm fiber media).
- 100BASE-FX to 100BASE-SX (100Mbps 850nm fiber media and 100Mbps 1300nm fiber media).

The ML6652 supports conversion between Twisted Pair Side, Fast Link Pulses (FLP) and Fiber Side, Fiber Link Negotiation Pulses (FLNP). It supports ISO/IEC 8802.3, IEEE 802.3, and TIA/EIA-785 including Auto-Negotiation on both twisted pair and fiber optics.

The ML6652 data interfaces can all be configured in a number of ways. The twisted pair inputs and outputs can be configured in Twisted Pair Mode to interface with a 1:1 transformer for transmit and receive or in PECL/LVPECL Mode to interface a PMD module. The fiber optic inputs and outputs can be configured in Quantizer/Fiber Optic Mode with an LED driver or in PECL/LVPECL Mode. LED status outputs identify internal operational status.

The ML6652 operating modes are configurable through control input pins (at power up) or through management control registers that are programmable through an interface protocol compatible with MII Serial Management Interface as defined in IEEE 802.3-1998 standards.

CONFIGURABLE MODES

Operating Modes (Forced, Transparent And Non-transparent)

- 1) FORCED 10Mbps only mode,
- 2) FORCED 100Mbps only mode,
- 3) NON-TRANSPARENT Half Duplex only, with Auto-Negotiation
- 4) NON-TRANSPARENT Full and Half Duplex with Auto-Negotiation
- 5) TRANSPARENT 10/100Mbps with Auto-Negotiation
- 6) NON-TRANSPARENT Special case

Interface Modes

- 1) Twisted pair interface
 - a) Twisted Pair (Transformer input) Mode or
 - b) PECL/LVPECL Mode
- b) Fiber Optic Interface
 - i) Quantizer/Fiber Optic LED Driver Mode or
 - ii) PECL/LVPECL Mode

Special Modes

- 1) Power Down Mode
 - a) Configurable through:
 - (i) Control pin 24 or
 - (ii) Management control register
- 2) Loopback Test Modes
 - a) For the fiber optic interface or
 - b) The twisted pair interface
 - c) Both are configurable through the Management control register and include bypassing clock and data recovery blocks.
- 3) Transmitter Output Off Mode:
 - a) Twisted Pair or
 - b) Fiber Optic
 - c) Both are configurable through the Management control registers or control pins TPOUTOFF# (pin 13) and FOOUTOFF# (pin 14).
- 4) Backup Link Mode
 - a) Configurable through Management control register or via BCKPLINK (Pin 40).

FUNCTIONAL DESCRIPTION

DEVICE CONFIGURATION

Configuring the ML6652 Media Converter is accomplished through input configuration pins or bits in management control register 30. Configuration pins AD4LIW, AD32 and AD10 determine the PHY address used with the serial management interface consisting of MDIO (pin 16) and MDC (pin 17). The setting of any R/W bit in the control management registers can be modified by writing data to the register through the serial management interface. The control management registers 27, 28, 30, and 31 always indicate the current operating mode of the ML6652.

The PHY address settings defined by AD4LIW (pin 4), AD32 (pin 5), and AD10 (pin 6) are latched and must remain stable during any serial management interface read or write operation. The PHY address pins each have four (4) distinct input levels and together encode the required five (5) bit PHY addresses. Nominal values of VCC and 0V are obtained with directions to VCCD or GNDD. Nominal values of 2/3 VCC and 1/3 VCC must be developed with external resistor dividers.

Input pins SPEED (pin 27) and DUPLEX (pin 25) are three level inputs having internal 80kΩ resistors connected to both VCC and Ground. Nominal input voltage levels are VCC, VCC/2, when input is left floating, and Ground. The state of configuration pins DUPLEX, SPEED, PECLTP (pin 7) PECLQU (pin 8), and AD4LIW (pin 4) are latched 3μ to 8μs after:

- 1) system power up (internal signal POR going low)
- 2) trailing edge of PWRDWN# (pin 24) Ground to VCC
- 3) reset <30.13> is cleared.

Input pins PECLTP (pin 7) and PECLQU (pin 8) are 4 level input pins with no internal pull-up or pull-down resistors connected. Nominal values of VCC and 0V are obtained with directions to VCC or Ground. Nominal values of 2/3 VCC and 1/3 VCC must be developed with external resistor dividers.

DEFAULT POWER ON CONFIGURATION

This configuration method can be used to set the device whenever the MII serial management interface is not available. The logic levels at configuration pins DUPLEX, SPEED, PECLTP, PECLQU and AD4LIW are decoded and latched in management control registers 28, 30 and 31 after system power up or after a (low) to (high) transition at PWRDWN#.

SERIAL MANAGEMENT INTERFACE

The ML6652 has management functions controlled by three sixteen bit registers and status updated by one sixteen bit registers. Management Data is input and output through MDIO and clocked by MDC in an interface compatible with the protocol defined in clause 22 of IEEE Std 802.3-1998 MII Serial Management Interface. The address bits PHYAD <4:0> are determined by voltage levels at configuration pins AD4LIW, AD32, and AD10.

Management interface read and write timing relationships are shown in Figures 2 and 3.

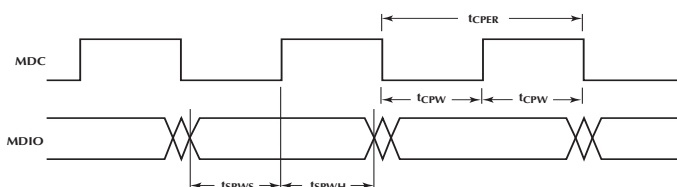

Figure 2. Write

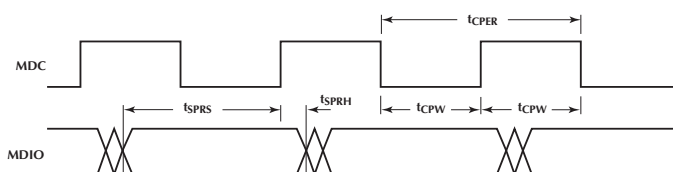

Figure 3. Read

FUNCTIONAL DESCRIPTION

SPEED SELECTION

The Operating modes, FORCED, TRANSPARENT and NON-TRANSPARENT are chosen at power up by setting of the DUPLEX and SPEED pins. Thereafter the operating modes may be set by toggling bits in management register 30.

DUPLEX and SPEED must be used concurrently to set the mode of the ML6652 see Tables 6 and 7.

Management Interface Operating Modes	Bit <30.11> TRANSPARENT#	Bit <30.15> ADVERTHD#	Bit <30.14> DSBLAN	Bit <30.10> ADVERTFD#	Bit <30.9> SINGLESPEED	Bit <30.8> SEL10Mbps
Forced 10	N/A	N/A	1	N/A	1	1
Forced 100	N/A	N/A	1	N/A	1	0
Non-Transparent Half-DUPLEX	1	0	0	1	0	0
Non-Transparent	1	0	0	0	0	0
Transparent	0	0	0	0	0	0

Table 7.

OPERATING MODES

Operating Modes are:

- 1) **Forced 10**
0 (zero) Volt input on SPEED (or the equivalent Reg. 30 settings) enables only FORCED 10Mbps operation. 100Mbps and Auto-Negotiation are disabled. Link Integrity Warning (LIW) can also be enabled.
- 2) **Forced 100**
VCC input on SPEED (or the equivalent Reg. 30 settings) enables FORCED 100Mbps operation only. 10Mbps and Auto-Negotiation are disabled. Link Integrity Warning (LIW) can also be enabled.
- 3) **Non-Transparent Half-DUPLEX**
VCC/2 (input floating) input on SPEED (or the equivalent Reg. 30 settings) enables Transparent or non-transparent 10Mbps and 100Mbps operation. DUPLEX input (0 Volts at power up) or management register 30 select NON-TRANSPARENT Mode of operation and force Half-DUPLEX. Non-transparent mode was designed for networks that have Auto-Negotiation capabilities only on the copper side. The ML6652 operates in Non-Transparent Mode when all of the following four conditions are met:
 - a) Duplex input is a VCC or a 0 Volts (or the equivalent Reg. 30 settings) AND
 - b) Twisted Pair Link is Auto-Negotiation capable AND
 - c) Fiber Optic Link Partner is not Auto-Negotiation capable AND
 - d) Both 10Mbps and 100Mbps operation are enabled by SPEED input at VCC/2 or by bits in management register 30.

In this mode, the twisted pair output is disabled until signal is detected at both the twisted pair and the fiber optic inputs. The fiber optic output is not disabled, and it shows the input signal from the twisted pair interface converted to the equivalent fiber optic technology.

When the TP link partner negotiates the link through the Auto-Negotiation protocol and FLP bursts reach the ML6652 operating in the Non-Transparent mode, the ML6652 will start generating its own FLP Bursts advertising the speed detected at the FO input and the DUPLEX mode selected through the DUPLEX pin or through the management interface bits 30.15 and 30.10. The ML6652 will transmit FLP Bursts as long as it receives FLP Bursts from the TP link partner. (The decision that the link is settled will be made by the TP link partner.)

Note 1: In Non-Transparent Half Duplex Mode, only the Half Duplex mode of operation is advertised through the Auto-Negotiation protocol. However nothing changes inside the ML6652, the transmit and receive paths are

completely separate and are always capable of simultaneous or full duplex use.

Note 2: SPEED and DUPLEX modes are the only abilities advertised in this mode by the ML6652

Note 3: Link Integrity Warning (LIW) can not be enabled in this mode.

- 4) **Non-Transparent**
VCC/2 (input floating) input on SPEED (or the equivalent Reg. 30 settings) enables Transparent or non-transparent 10Mbps and 100Mbps operation. DUPLEX input (VCC at power up) or management register 30 select NON-TRANSPARENT Mode of operation. Non-transparent mode was designed for networks that have Auto-Negotiation capabilities only on the copper side. The ML6652 operates in Non-Transparent Mode when all of the following four conditions are met:
 - a) Duplex input is a VCC or a 0 Volts (or the equivalent Reg. 30 settings) AND
 - b) Twisted Pair Link is Auto-Negotiation capable AND
 - c) Fiber Optic Link Partner is not Auto-Negotiation capable AND
 - d) Both 10Mbps and 100Mbps operation are enabled by SPEED input at VCC/2 or by bits in management register 30.

In this mode, the twisted pair output is disabled until signal is detected at both the twisted pair and the fiber optic inputs. The fiber optic output is not disabled, and it shows the input signal from the twisted pair interface converted to the equivalent fiber optic technology.

When the TP link partner negotiates the link through the Auto-Negotiation protocol and FLP bursts reach the ML6652 operating in the Non-Transparent mode, the ML6652 will start generating its own FLP Bursts advertising the speed detected at the FO input and the DUPLEX mode selected through the DUPLEX pin or through the management interface bits 30.15 and 30.10. The ML6652 will transmit FLP Bursts as long as it receives FLP Bursts from the TP link partner. (The decision that the link is settled will be made by the TP link partner.)

Note 1: SPEED and DUPLEX modes are the only abilities advertised in this mode by the ML6652

Note 2: Link Integrity Warning (LIW) can not be enabled in this mode.

- 5) **Transparent**
VCC/2 (input floating) input on SPEED (or the equivalent Reg. 30 settings) enables Transparent or non-transparent 10Mbps and 100Mbps operation. DUPLEX input and management register 30 select

OPERATING MODES

TRANSPARENT or NON-TRANSPARENT Mode of operation. Transparent Mode is the default mode of operation for the ML6652 when DUPLEX input is VCC/2. In this mode, the control circuit implements the state diagrams of the Auto-Negotiation sub-layer defined in clause 5 of TIA/EIA-785 standard. In general the enabled Physical Media Attachment (PMA) at the fiber optic output is the equivalent to the technology detected at the twisted pair input and the enabled PMA at the twisted pair output is the equivalent to the technology detected at the fiber optic input. Of course system Auto-Negotiation causes both paths to the greatest common denominator. The system chooses the greatest common denominator in the following order least to greatest:

- a) Half DUPLEX, 10Mbps
- b) Full DUPLEX, 10Mbps
- c) Half DUPLEX, 100Mbps
- d) Full DUPLEX, 100Mbps

Note: In transparent mode the ML6652 does not generate information. It only takes the information from the link partner on one side (without adding or remove any information) and it translates it to the language of the link partner of other side.

This mode is for use in networks that have Auto-Negotiation capabilities on both copper and fiber sides. The ML6652 follows the demands of the far end link partners during the network Auto-Negotiation. Link Integrity Warning (LIW) cannot be enabled in this mode.

6) Special case for the Non-Transparent Mode:

The ML6652 operates in this mode when all of the following three conditions are met:

- a) Duplex input is a VCC or a 0 Volts (or the equivalent Reg. 30 settings) AND
- b) Twisted Pair Link is Auto-Negotiation capable AND
- c) Both 10Mbps and 100Mbps operation are enabled by SPEED input at VCC/2 or by bits in management register 30.

If the Fiber Optic Link Partner is Auto-Negotiation capable the ML6652 will allow the fiber optic link partner to Auto-Negotiate through the ML6652 to the twisted pair link partner. In this special case the non-transparent mode acts in the same way as the transparent mode. This is because the self-generation of FLP bursts is suppressed by the presence of the FLP bursts from the fiber link partner.

The ML6652 can be configured in two general ways:

- 1) Through the management interface, pins 16 (MDIO) and 17 (MDC), all of the registers can be changed after power-up. The management interface settings override any power-up register settings.

- a) All internal registers may be used to:
 - i) Set operating modes,
 - (1) FORCED 10Mbps only mode,
 - (2) FORCED 100Mbps only mode,
 - (3) NON-TRANSPARENT Half Duplex only
 - (4) NON-TRANSPARENT Full and Half Duplex with Auto-Negotiation
 - (5) TRANSPARENT 10/100Mbps with Auto-Negotiation
 - ii) Select interface configurations
 - (1) Both fiber and copper
 - iii) Special modes
 - (1) Power Down Mode
 - (2) Loopback Test Modes
 - (3) Transmitter Output Off Mode:
 - (4) Backup Link Mode (Pin 40)
 - iv) And read control information

2) Through configuration and control pins

Note: Pins 4 AD4LIW and 40 BCKPLINK are both shared between a power-up read and a later control function and thus appear in both lists. Pin 4 AD4LIW is read and the condition latched to set register 30 bit 12 subsequently it is used as an unlatched address pin. Pin 40 BCKPLINK is read and the condition latched to set register 28 bit 1, subsequently it is used as an output to drive a second ML6652 to provide back up link.

- a) At power up the following pins are read and the appropriate registers are set: (but with a limited sub-set of the control afforded by the management control registers.)
 - i) Pin 7 (PECLTP)
 - ii) Pin 8 (PECLQU)
 - iii) Pin 25 (DUPLEX)
 - iv) Pin 27 (SPEED)
 - v) Pin 4 (AD4LIW)
 - vi) Pin 40 (BCKLINK)

Note: These pins are typically read a few microseconds after power-up, if they are tied to supplies that do not track the ML6652 power improper results may occur. To reduce the parts count, pins Pin 7 (PECLTP), Pin 8 (PECLQU), Pin 4 (AD4LIW), Pin 5 (AD 32) and Pin 6 (AD10) may be supplies from a common 20kΩ resistor tree as shown on our evaluation boards schematics

OPERATING MODES

(without thoroughly understanding your PCB layout power up dynamics the safest course is to make short connections and do not to add decoupling capacitors to these pins).

When Pin 7 (PECLTP) and Pin 8 (PECLQU) are connected to 1/3 VCC and 2/3 VCC use >20kΩ resistors and connect to the proper decoupled VCCD and GNDD. For Pin 7 (PECLTP) use Pin 19 VCCD and Pin 15 GNDD, do not add decoupling capacitors to Pin 7. For Pin 8 (PECLQU) use Pin 19 VCCD and Pin 15 GNDD, do not add decoupling capacitors to Pin 8. When Pin 25 (DUPLEX) and Pin 27 (SPEED) are connected to VCC/2 use the internal 80kΩ resistor pair by leaving the pin open. Do not add external resistors or decoupling capacitors these pins.

When Pin 4 AD4LIW is connected to 1/3 and 2/3 VCC use >20kΩ resistors and connect to the proper decoupled VCCD and GNDD. When Pin 4 AD4LIW is connected to ground use Pin 15 GNDD. When Pin 4 AD4LIW is connected to VCC use Pin 19 VCCD and do not add decoupling capacitors to pin 4 AD4LIW. Pull Pin 40 BCKPLINK up and down (One and Zero) through a 10K resistor connected to either Pin 19 VCCD or Pin 15 GNDD.

- b) The following pins are available at all times for control: (Note: When Pin 4 (AD4LIW) Pin 5 (AD 32) and Pin 6 (AD10) are connected to 1/3 VCC and 2/3 VCC use >20K ohm resistors and connect to the proper decoupled Pin 19 VCCD and Pin 15 GNDD do not add decoupling capacitors to Pin 4, 5 or 6.)
 - i) Pin 4 (AD4LIW)
 - ii) Pin 5 (AD 32)
 - iii) Pin 6 (AD10)
 - iv) Pin 13 (TPOUTOFF#)
 - v) Pin 14 (FOOUTOFF#)
 - vi) Pin 24 (PWRDWN#)
 - vii) Pin 40 (BCKPLINK)
- c) LED Status indicators are available:
 - i) Pin 41 (TPINSPD)
 - ii) Pin 42 (FOINSPD)
 - iii) Pin 43 (TPANDT)
 - iv) Pin 44 (FOANDT)

Thus the ML6652 is designed to self-configure in stand alone applications as well as act under the control of a microprocessor or other control device in a managed setting.

TRANSPARENT MODE

Twisted Pair Input/Output Interface

Two operating modes are available for the twisted pair differential inputs TPINP (pin 10)/TPINN (pin 11) and the differential output pair TPOUTP (pin 1)/TPOUTN (pin 3) selected by the input configuration pin PECLTP (pin 7) or by the setting of bit <30.3> in management register 30.

In twisted pair interface mode, the inputs form a differential pair that receives twisted pair positive and complementary signals and the outputs form a differential current output pair that drives MLT-3 encoded 100BASE data, Manchester encoded 10BASE-T data or NLPs during 10Mbps mode, and FLP bursts during Auto-Negotiation into a network coupling 1:1 transformer.

To communicate between two fiber optic sources, the twisted pair input and output can be configured as PECL/LVPECL interface compatible with the configuration pin PECLTP or by setting bit <30.3> high. In this mode, both the input differential pair and the output differential pair provide PECL/LVPECL compatible interface positive and complementary levels.

The preferred mode of operation is twisted pair compatible signal levels. The default mode of operation is set by PECLTP (pin 7).

Fiber Optic input/Output Interface

Two modes of operation are available for the fiber optic inputs FOINP (pin 33), FOINN (pin 32) and the fiber optic outputs IOUT (pin 21) and IOUT# (pin 22) selected by input control pin PECLQU (pin 8) or by the setting of bit <30.7> in management register 30.

PECLQU is a four level input and when set at VCC/3 by an external resistor network the two outputs IOUT/IOUT# form a differential output pair that are AC coupled to a fiber optic PMD module. The differential current output pair output NRZI encoded 100BASE-FX or 100BASE-SX symbols in 100Mbps mode. They output Manchester encoded 10BASE-FL data or Optical Idle (OPT_IDL) in 10Mbps mode and FLNP bursts during Auto-Negotiation. IOUT and IOUT# require external pull-up resistors to VCC and must be AC coupled to a fiber optic PMD module. A resistor network is required to establish the common mode voltage at the inputs to the PMD module.

With PECLQU input level of VCC, 2VCC/3, or 0Volts, the two outputs become independent and are defined as the Fiber Optic Interface Mode. In this mode, IOUT becomes a data output to a fiber optic LED driver connecting to the cathode. The data is NRZI encoded 100BASE-FX or 100BASE-SX symbols in 100Mbps mode. The data is Manchester encoded 10BASE-FL or OPT_IDL in 10Mbps mode and FLNP Bursts during Auto-Negotiation.

IOUT# is optionally used to provide current peaking. If current peaking is implemented, typically a 1kΩ off-chip

OPERATING MODES

resistor is connected to ground and a 1nf capacitor is connected to IOUT to determine the peaking current waveform. If peaking is not implemented, IOUT# should be connected directly to VCC.

The preferred mode of operation is PECL/LVPECL differential outputs. The default mode of operation is set by PECLQU (pin 8).

POWER DOWN MODE

Enabled by setting PWRDWN# (pin 24) all circuits are powered down, all internal control logic is reset, and output currents are turned off. 3 μ s to 8 μ s after the low to high transition (trailing edge) of PWRDWN# the logic levels at configuration input pins DUPLEX (pin 25), SPEED (pin 27), PECLTP (pin 7), PECLQU (pin 8), AD4LIW (pin 4), and BCKLINK (Pin 40) are latched in the ML6652 and all management control register bits are reset.

Enabled by setting management register bit <31.15> high, all circuits are powered down, (except the management interface) all internal control logic is reset and output currents are turned off. Control input pins DUPLEX, SPEED, PECLTP, PECLQU, and AD4LIW are not relatched and management control register bits are not reset.

LOOPBACK MODE

Loopback of both the twisted pair inputs and fiber optic inputs to their respective differential outputs is possible with the ML6652.

Enabled by setting management register bit <31.12>, the twisted pair input signal at TPINP (pin 10) and TPINN (pin 11) are looped back to TPOUTP (pin 1) and TPOUTN (pin 3). The clock/data PLL is normally included in the loopback path. Setting management register bit <31.10> PLLPBK# active (low) removes the PLL from the loopback path.

Enabled by setting management register bit <31.11>, the fiber input signal at FOINP (pin 33) and FOINN (pin 32) are looped back to IOUT (pin 21) and IOUT# (pin 22). The clock/data PLL is normally included in the loopback path. Setting management register bit <31.10> PLLPBK# active (low) removes the PLL from the loopback path.

SCRAMBLER/DESCRAMBLER

The scrambler and descrambler functions are enabled in the 100Mbps signal paths by setting the management register bit <30.1>. The scrambler and descrambler are compliant with the Fiber Distributed Data Interface Twisted Pair-Physical Media Dependent (FDDI TP-PMD) standard ANSI X3T9.5 PMD/312. Setting management register bit <30.0> forces the 11-bit scrambler register state to 0000000011(bin). Clearing <30.0> returns the scrambler register to normal operation.

The default state for <30.0> is logic 0 or normal scrambler operation.

OUTPUT OFF MODE

Either the twisted pair outputs or the fiber optic outputs can be turned off by a control input pin or a management register bit. Disabling either differential output results in the output pair being turned off and the data output pins entering a high impedance state.

The twisted pair differential output TPOUTP and TPOUTN is turned off by setting TPOUTOFF# low or management register bit <31.13> high. The fiber optic differential output IOUT and IOUT# is turned off by setting FOOUTOFF# low or management register bit <31.14> high.

BACKUP LINK MODE

A backup link mode of operation is available when the primary fiber optic link is down. It can only be enabled in the 100Mbps only, non-loopback mode of operation configured by SPEED (pin 27) input level set to VCC. Two ML6652 devices are required to implement the backup link mode of operation with one driving the primary fiber optic link and the second driving the backup or secondary fiber optic link.

If a backup fiber optic link mode of operation is not implemented, BCKPLNK (pin 40) is connected to VCC.

Backup Link Mode is enabled in the primary ML6652 by connecting a 10k Ω resistor in series with an LED from BCKPLNK (pin 40) with the LED cathode to ground. Configuring the two ML6652 media converters simply requires BCKPLNK (pin 40) of the primary device to be connected to TPOUTOFF# of the secondary device.

A second configuration is suggested to avoid confusion; that is Pin 40 (BCKPLNK) of the primary ML6652 is connected to both pin 13 (TPOUTOFF#) and 14 (FOOUTOFF#) of the secondary ML6652, disabling both copper and fiber outputs. A third configuration, if Pin 24 (PWRDWN#) of the secondary ML6652 is not being used to control power usage by the system (for example in a stand alone configuration without system microprocessor control) Pin 40 (BCKPLNK) of the primary ML6652 can be connected to Pin 24 (PWRDWN#) of the secondary ML6652, powering down the secondary ML6652 to save power.

The primary link is not functioning if a Far End Fault (FEF) signal is received on the fiber optic differential input pair FOINP and FOINN as defined in clause 24 of IEEE Std. 802.3-1998, or when the fiber optic signal does not meet the 100Mbps signal detection constraints.

When Backup Link Mode is enabled, the input and output signal dependencies are related as shown in Table 8.

OPERATING MODES

Input Signal at pins FOINP/FOINN	Input Signal at pins TPINP/TPINN	FOINSPD Output: Input Speed Indicator		BCKPLINK Output: Enabler of Secondary Link			Output Signal at pins IOOUT/IOOUT#
		Output Level	LED Cathode to Ground	Output Level	LED Cathode to Ground	Secondary Twisted Pair Output	
Good 100Mbps signal and not FEF	NA	High	On	Low	Off	High Impedance	TPINP/TPINN Equivalent
FEF Pattern	NA	High	On	High	On	Enabled	TPINP/TPINN Equivalent
Not good 100Mbps signal	Good 100Mbps signal	Low or High-Z	Off	High	On	Enabled	FEF Pattern
Not good 100Mbps signal	Not good 100Mbps signal	Low or High-Z	Off	High	On	Enabled	High Impedance

Table 8.

LED Interface

The recommended LED configuration for Pins 41 (TPINSPD) and 42 (FOINSPD) is shown in Figure 4 and Table 9. Note: R2 may be as low as 511Ω to insure only one LED at a time will be on.

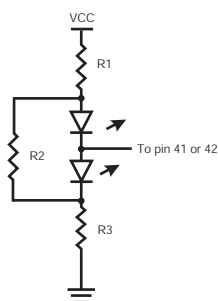

Figure 4.

LED's Von	R1	R2	R3
2.1-2.2V	100	1.2K	100
1.8-1.9V	150	1.2K	150
1.7V	200	1K	200

Table 9. LED Colors vs. Resistor Values for Figure 4

CONTROL REGISTERS

Control Registers

Register 31 ADDR 11111 (bin) 1F (hex) All bits are R/W All bits default to 0

Bit	Name	Description	R/W	Default
15	PowerDown	Setting bit to 1 powers down all circuits and resets all control logic. Register bits are not reset (except the management interface) and new configuration data is not loaded	R/W	0
14	FOOUTOFF	Setting bit to 1 turns off the output stage of the Fiber Optic driver leaving the output pins in a high impedance state. Setting bit to 1 creates the exact same results as a 0 input on FOUTOFF#	R/W	0
13	TPOUTOFF	Setting bit to 1 turns off the output stage of the twisted pair line driver leaving the output pins in a high impedance state. Setting bit to 1 creates exact same result as 0 input on TPOUTOFF#	R/W	0
12	LPBKTOTP	Setting bit to 1 directs TPINP (pin 10) and TPINN (pin 11) to loop back to TPOUTP (pin 1) and TPOUTN (pin 3). Including the PLL in the 100Mbps signal path is controlled by <31.10>, PLLLPBK#	R/W	0
11	LPBKTOFO	Setting bit to 1 directs FOINP (pin 33) and FOINN (pin 32) to loop back to IOUT (pin 21) and IOUT# (pin 22). Including the PLL in the 100Mbps signal path is controlled by <31.10> PLLLPBK#.	R/W	0
10	PLLLPBK#	Setting bit to 1 removes the clock/data recovery PLL from the signal path during 100Mbps loop back modes	R/W	0
7-4	Reserved			
3-0	Reserved			

Register 30 ADDR 11110 (bin) 1E (hex) All bits are R/W

Bit	Name	Description	R/W	Default
15	ADVERTHD#	Setting bit to 1 AND TRANSPARENT# <30.11> set to 1 causes Half Duplex capability to be advertised in FLP bursts Setting bit to 0 AND TRANSPARENT# <30.11> set to 1 causes Half Duplex capability to not be advertised in FLP bursts Setting TRANSPARENT# <30.11> to 0 causes ADVERTHD# to be ignored	R/W	0
14	DSBLAN	Setting bit to 1 disables detection of FLNP and FLP bursts	R/W	Set by SPEED (pin 27)
13	RESET	Setting this bit to 1 causes all configuration pins to be read and all register bits to be initialized 3 to 8 μ s after the bit is returned to a 0. The bit is self clearing	R/W	0
12	LIW	Setting this bit to 1 enables the Link Integrity Warning function	R/W	Set by AD4LIW (pin 4)
11	TRANSPARENT#	Setting bit to 1 enables NON-TRANSPARENT Mode of operation Setting bit to 0 enables TRANSPARENT Mode of operation	R/W	Set by DUPLEX (pin 25)
10	ADVERTFD#	Setting bit to 0 and TRANSPARENT# <30.11> set to 1 causes Full Duplex capability to be advertised in FLP bursts Setting bits to 1 and TRANSPARENT# <30.11> set to 0 causes Full Duplex capability to not be advertised in FLP bursts Setting TRANSPARENT# <30.11> to 0 causes ADVERTFD# to be ignored	R/W	Set by DUPLEX (pin 25)

CONTROL REGISTERS

Control Registers

Register 30 Continued

Bit	Name	Description	R/W	Default
9	SINGLESPEED	Setting this bit to 1 enables only a single data rate	R/W	Set by SPEED (pin 27)
8	SEL 10Mbps	Setting bit to 1 and SINGLESPEED <30.9> is 1 enables only 10Mbps data rate Setting bit to 0 and SINGLESPEED <30.9> enables only 100Mbps data rate	R/W	Set by SPEED (pin 27)
7	PECLQU	Setting bit to 1 causes the interface at FOINP (pin 33), FOINN (pin 32), IOUT (pin 21), and IOUT# (pin 22) to be PECL/LVPECL compatible	R/W	Set by (pin 8)
6	LONGWL	Setting bit to 1 assumes optical wavelength to be 1300nm Setting this bit to 0 assumes optical wavelength to be 850nm when the quantizer/fiber optic LED driver are used. If PECLQU <30.7> is set to 1 or SHORTFO <30.5> is set to 1 LONGWL is ignored	R/W	Set by PECLQU (pin 8)
5	SHORTFO	Setting bit 1 sets up the signal detection circuit for a fiber maximum link distance of 300 meters in both 10Mbps and 100Mbps modes when the quantizer/fiber optic LED driver is used. Setting bit to 0 sets up the signal detection circuit for a maximum link distance of 2Km, when the quantizer/fiber optic LED driver are used. If PECLQU <30.7> is set to 1 SHORTFO is ignored	R/W	Set by PECLQU (pin 8)
4	LOWITPOUT	Setting bit to 1 causes TPOUTP (pin 1) and TPOUTN (pin 3) output current to be reduced to 25% of the standard twisted pair output current. The output remains 100BASE-TX, 10BASE-T, or FLP Bursts. If PECLTP <30.3> is set to 1, LOWITPOUT is ignored	R/W	Set by PECLTP (pin 7)
3	PECLTP	Setting bit to 1 causes the interface at TPINP (pin 10), TPINN (pin 11), TPOUTP (pin 1), and TPOUTN (pin 3) to be PECL or PECL compatible	R/W	Set by PECLTP (pin 7)
2	SHORTTP	Setting bit to 1 sets up the twisted pair interface receiver circuit for a maximum link distance of 10 meters, bypassing the Unshielded Twisted Pair (UTP-5) equalizer. Setting bit to 0 maintains the equalizer in the signal path. If PECLTP <30.3> is set to 1, SHORTTP is ignored	R/W	Set by PECLTP (pin 7)
1	SCRON	Setting bit to 1 enables scrambler/descrambler function. Setting bit to 0 disables both functions	R/W	Set by PECLTP (pin 7)
0	RSTSCR	Setting bit to 1 forces the scrambler register state to 0000000011 (binary) Setting bit to 0 releases logic in the scrambler block	R/W	0

REGISTER 28 ADDR 11100 (bin) 1C (hex) All bits are Read Write

Bit	Name	Description	R/W	Default
15-5	Reserved		R/W	0
4	SLOWMLT3	Set high (1) reduces rise and fall times of MLT-3 outputs on pins TPOUTP(1) and TPOUTN(3)	R/W	0
3	FSENSEDIS	Set high (1) disables 100 Mbps PLL frequency sensing circuits	R/W	0
2	FEFDSBL	Set high (1) disables Far-End-Fault pattern generation and detection.	R/W	0
1	BCKPDIS	Set high (1) disables Backup Link function and overwrites BCKPLINK (40) configuration setting.	R/W	0
0	Reserved		R/W	0

STATUSREGISTERS

Status Registers

Register 27 ADDR 11011 (bin) 1B (hex) All bits are Read Only

Bit	Name	Description
15	FOFORCELO	This bit set high when the fiber optic input PLL follows the local oscillator
14	FOBADFREQ	This bit set high when there is a large difference between the frequency of the reference clock and the frequency of the VCO of the fiber optic input PLL. The low frequency threshold is between 121 and 123MHz, and the high frequency threshold is between 127 and 129MHz. This indicator is disabled when "FSENSEDIS" bit <28.3> is 1 or when the filter of the PLL is being reset.
13	FEFDETECT	This bit set high when the Far End Fault (FEF) pattern is detected at the fiber optic input interface
12	TPFORCELO	This bit set high when the twisted pair input PLL follows the local oscillator
11	TPBADFREQ	This bit set high when there is a large difference between the frequency of the reference clock and the frequency of the VCO of the twisted pair input PLL. The low frequency threshold is between 121 and 123MHz, and the high frequency threshold is between 127 and 129MHz. This indicator is disabled when "FSENSEDIS" bit <28.3> is 1 or when the filter of the PLL is being reset.
10	NOSEED	This bit set high when the descrambler is enabled and the seed is not updated for 1.3ms to 2ms. This bit set low when the seed is updated. The high value is latched until it's read. Default is 0
9	TPLINKSTATUS	This bit set high when the twisted pair link is up. This bit is latched low until read. It only applies to NON-TRANSPARENT Mode. It is always low in TRANSPARENT Mode
8	ANCOMPL	Auto-Negotiation Complete. This bit set high indicates that the Auto-Negotiation process on the twisted pair link is completed. It only applies to NON-TRANSPARENT Mode. It is always low in TRANSPARENT Mode
7	TPIN100	This bit set high indicates that 100Mbps signal is being detected at the twisted pair input interface
6	TPIN10	This bit set high indicates that 10Mbps signal is being detected at the twisted pair input interface
5	DATACTOF	This bit set high indicates that a data packet has been detected at the twisted pair input. This bit is latched high until it's read. This bit is always low if both TPIN10 and TPIN100 are low
4	FLP	This bit set high, when FLP Bursts are detected at the twisted pair input interface. It is also set high when FLNP Bursts are detected at the twisted pair interface when PECL mode is selected for it
3	FOIN100	This bit set high when 100BASE-FX or 100BASE-SX signal is being detected at the fiber optic input interface
2	FOIN10	This bit set high when 10BASE-FL signal is being detected at the fiber optic input interface
1	DATAFTOC	This bit set high when a data packet has been detected at the fiber optic input. This bit is latched high until it's read. This bit is always low if both FOIN10 and FOIN100 are off
0	FLNP	This bit set high when FLNP Bursts are detected at the fiber optic input interface

ELECTRICAL CHARACTERISTICS

ABSOLUTE MAXIMUM RATINGS

Absolute maximum ratings are those values beyond which the device could be permanently damaged. Absolute maximum ratings are stress ratings only and functional device operation is not implied.

Junction Temperature	150°C
Storage Temperature Range	-65°C to 150°C
Lead Temperature (Soldering, 10s)	240°C
Thermal Resistance (θ_{JA})	56°C/W(TQPF)
Thermal Resistance (θ_{JA})	33°C/W(LPCC/QFN)
Input Voltage Range	Ground - 0.3V to VCC +0.3V
Output Current	
TPOUTP/TPOUTN	80mA
IOUT	120mA
IOUT#	-100mA
All other inputs	10mA

OPERATING CONDITIONS

Power Supply Voltage Range	3.3V \pm 5%
All VCC supply pins must be within 0.1V of each other	
Operating Temperature Range	
ML6652CH/ML6652CM	0°C to 70°C
ML6652EH/ML6652EM	-20°C to 85°C

ELECTRICAL TABLES

SYMBOL	PARAMETER	CONDITIONS	MIN	TYP	MAX	UNITS
POWER SUPPLY CURRENT						
	Supply current transmitting 100BASE-TX and 100BASE-SX data packets	RTTP= 2K Ω RTOP=1.4K Ω Current into all VCC pins		150	200	mA
	Supply current transmitting 10BASE-T and 10BASE-FL data packets	RTTP= 2K Ω RTOP=1.4K Ω Current into all VCC pins		100	120	mA
	Power Down mode current	RTTP=2K Ω RTOP=1.4K Ω Current into all VCC pins		2		mA
	Supply current transmitting 100Mbps signal with 2 PECL interfaces	RTTP=2K Ω RTOP=1.4K Ω Current into all VCC pins		120	150	mA
	Supply current transmitting 10Mbps signal with 2 PECL interfaces	RTTP=2K Ω RTOP=1.4K Ω Current into all VCC pins		60	100	mA
TTL INPUTS: MDC AND MDIO						
	Input High Voltage		2			V
	Input Low Voltage				0.8	V
	Input High Leakage Current	VIN = 2.4V	-10		10	μ A
	Input Low Leakage Current	VIN = .4V	-10		10	μ A
TTL OUTPUTS: MDIO, FOINSPD, TPINSPD, AND BCKPLINK#						
	Output High Voltage	Sourcing 2mA	2.4			V
	Output Low Voltage	Sinking 2mA			0.4	V
CMOS INPUTS: REFCLK, PWRDWN#, TPOUTOFF#, AND FOUTOFF#						
	Input High Voltage		2			V
	Input Low Voltage				0.8	V
	Input High Leakage Current	VIN = 2.4V	-10		10	μ A
	Input Low Leakage Current	VIN = 0.4V	-10		10	μ A

ELECTRICAL TABLES (CONTINUED)

SYMBOL	PARAMETER	CONDITIONS	MIN	TYP	MAX	UNITS
3-LEVEL CONFIGURATION INPUTS: SPEED AND DUPLEX						
	High Input Level		0.9 x VCCD		VCCD	V
	Middle Input Level		0.4 x VCCD		0.6 x VCCD	V
	Low Input Level		0 (GNDD)		0.1 x VCCD	V
4-LEVEL CONFIGURATION INPUTS: PECLTP, PECLQU, AF4LIW, AD32, AD10						
	High Input Level		0.9 x VCCD		VCCD	V
	Middle High Input Level		0.6 x VCCD		0.8 x VCCD	V
	Middle Low Input Level		0.2 x VCCD		0.4 x VCCD	V
	Low Input Level		0 (GNDD)		0.1 x VCCD	V
STATUS LED OUTPUTS PIN 43 AND PIN 44						
	Output "On" Current (Voltage at pin = 0.7V & VCC-0.7V)			3	4.1	mA
	Output "Off" Current (Voltage at pin = 0.7V & VCC-0.7V)		-10		10	µA
STATUS LED OUTPUTS PIN 41 AND PIN 42						
	Output "On" Current (Voltage at pin = 0.7V & VCC-0.7V)			3	4.1	mA
	Output "Off" Current (Voltage at pin = 0.7V & VCC-0.7V)		-10		10	µA
PECL/LVPECL COMPATIBLE INPUTS: TPINP, TPINN, FOINP, FOINN						
	Input High Voltage		VCC-1.225		VCC	V
	Input Low Voltage		1.5		VCC-1.3	V
	Differential Input High Voltage		200			mV
	Differential Input Low Voltage				-200	mV
	Input High Current		0		100	mA
	Input Low Current		-100		0	µA
PECL/LVPECL COMPATIBLE INPUTS: REQSD, SDFO, SDTH						
	Input High Voltage		VCC-1.225		VCC	V
	Input Low Voltage		1.5		VCC-1.3	V
	Differential Input High Voltage		250			mV
	Differential Input Low Voltage				-250	mV
	Input High Current		0		100	mA
	Input Low Current		-100		0	µA
PECL/LVPECL COMPATIBLE OUTPUTS: TPOUTP, TPOUTN, IOUT, IOUT#						
	Output High Voltage	With recommended resistor network. Refer to pin description	VCC-0.96		5.3	V
	Output Low Voltage	With recommended resistor network. Refer to pin description	1.3		VCC-1.73	V
	Differential Output Current	With recommended resistor network. Refer to pin description	9.5		11.5	mA
	Differential Output Current Imbalance	With recommended resistor network. Refer to pin description	-0.1		0.1	mA

ELECTRICAL TABLES (CONTINUED)

SYMBOL	PARAMETER	CONDITIONS	MIN	TYP	MAX	UNITS
TWISTED PAIR RECEIVER: TPINP, TPINN, REQSD						
	Common-Mode Voltage		VCC-1.0		VCC-0.4	V
	Differential Input Resistance	Between TPINP and TPINN	1.8		2.8	K Ω
	REQSD Input Current	5K Ω to ground, 25 $^{\circ}$ C	110		330	μ A
TWISTED PAIR TRANSMITTER: TPOUTP, TPOUTN, RTTP						
	Differential Peak Output Current	100BASE-TX, RTTP = 2K Ω	19		23	mA
	Differential Current Error	100BASE-TX, RTTP = 2K Ω		± 1		mA
	Differential Peak Output Current	Transmitting 10BASE-T Packets, RTTP = 2K Ω	35		55	mA
	Average Total Output Current [I(TPoutP)+I(TPoutN)]/2	Transmitting 10BASE-T Packets, RTTP = 2K Ω	65		140	mA
	Off State Output Current	Twisted Pair Transmitter Turned Off			10	μ A
	RTTP Input Current	RTTP=2K Ω			0.6	mA
FIBER OPTIC RECEIVER: FOINP, FOINN, CQOS						
	Common-Mode Voltage			VCC-1.35		V
	Differential Input Resistance			900		Ω
FIBER OPTIC TRANSMITTER: IOUT, IOUT#, RTOP						
	High Light State Output Current	RTOP = 1.4K Ω		100		mA
	Low Light State Output Current	RTOP = 1.4K Ω		10		mA
	Off-State Output Current	Fiber Optic Transmitter Turned Off		± 10		μ A
MANAGEMENT INTERFACE						
t _{CPER}	Period of clock at MDC	1.4V Crossing	80			ns
t _{CPW}	Pulse Width of clock at MDC	1.4V Crossing	30			ns
T _{SPWS}	MDIO Data Valid Before MDC Rising Edge Write Setup Time	1.4V Crossing	10			ns
t _{SPWH}	MDIO Data Valid After MDC Rising Edge Write Hold Time	1.4V Crossing	10			ns
t _{SPRS}	MDIO Data Valid Before MDC Rising Edge Read Setup Time	1.4V Crossing	30			ns
t _{SPRH}	MDIO Data Valid After MDC Rising Edge Read Hold Time	1.4V Crossing	0			ns
DESCRAMBLER						
	Synchronization update timer	100Mbps	1.3		2	ms
LATENCY						
	Twisted Pair Input to Fiber Optic Output	10Mbps		100		ns
	Twisted Pair Input to Fiber Optic Output	100Mbps		100		ns
	Fiber Optic Input to Twisted Pair Output	10Mbps		100		ns
	Fiber Optic Input to Twisted Pair Output	100Mbps		100		ns
REFERENCE CLOCK: REFCLK						
	Frequency Tolerance	25MHz Nominal	-100		+100	ppm
PECL/LVPECL COMPATIBLE OUTPUTS: TPOUTP, TPOUTN, IOUT, IOUT#						
	Differential Rise and Fall Time	10 to 90%, 5pF at each pin 100BASE-SX		3		ns

ELECTRICAL TABLES (CONTINUED)

SYMBOL	PARAMETER	CONDITIONS	MIN	TYP	MAX	UNITS
TWISTED PAIR RECEIVER: TPINP AND TPINN						
	Signal Detect Assertion Threshold	100BASE-TX		0.8		Vp-p
	Signal Detect De-assertion Threshold	100BASE-TX		0.4		Vp-p
	Amplitude Sensitivity Threshold	Link pulses		0.52		Vp
	Packet Activity Assertion Threshold	10BASE-T		0.55		Vp
	Packet Activity De-assertion Threshold	10BASE-T		0.42		Vp
TWISTED PAIR TRANSMITTER: TPOUTP AND TPOUTN						
	Differential Rise and Fall Time 10 to 90%	100BASE-TX, 50Ω resistors to VCC Transmitting unscrambled "H" symbols		3		ns
FIBER OPTIC RECEIVER: FOINP AND FOINN						
	Signal Detect Assertion Threshold	Low bandwidth, 10Mbps, Short Wave Length		6		mV
		Low bandwidth, 10Mbps, Long Wave Length		10		mV
		High bandwidth, 100Mbps, Short Wave Length		15		mV
		High bandwidth, 100Mbps, Long Wave Length		10		mV
	Signal Detect Assertion Threshold (continued)	Short link distance (300m, High bandwidth path, 10 or 100Mbps)		15		mV
	Voltage Threshold Hysteresis	10Mbps or Auto-Negotiation		20		%
		100Mbps		35		%
	Input Referred Offset			0.1		mV
	Input Referred Noise	10BASE-FL		50		μV
		100BASE-SX		150		μV
FIBER OPTIC RECEIVER: FOINP AND FOINN						
	Input Amplifier -3 dB Bandwidth	10BASE-FL		35		MHz
		100BASE-SX		180		MHz

PHYSICAL DIMENSIONS

Package: H44-10
44-Pin (10 x 10 x 1mm) TQFP

inches
(millimeters)

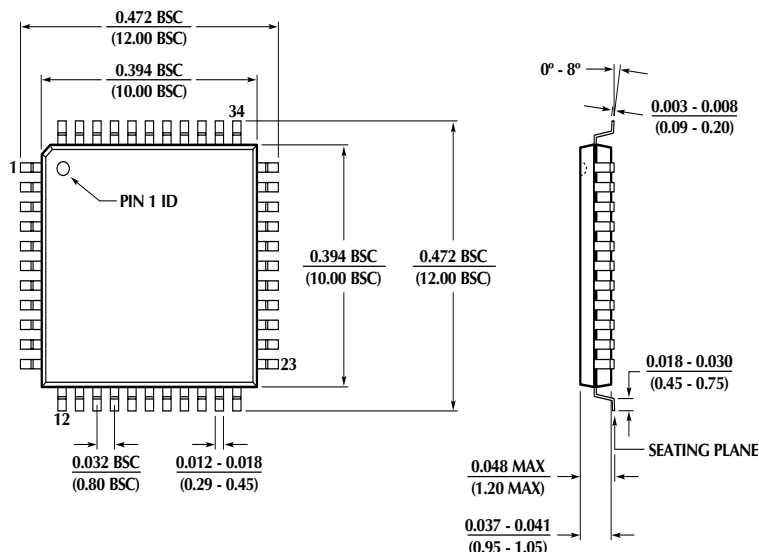

PACKAGE: M44-7
44-PIN (7 x 7 x 1mm) LPCC

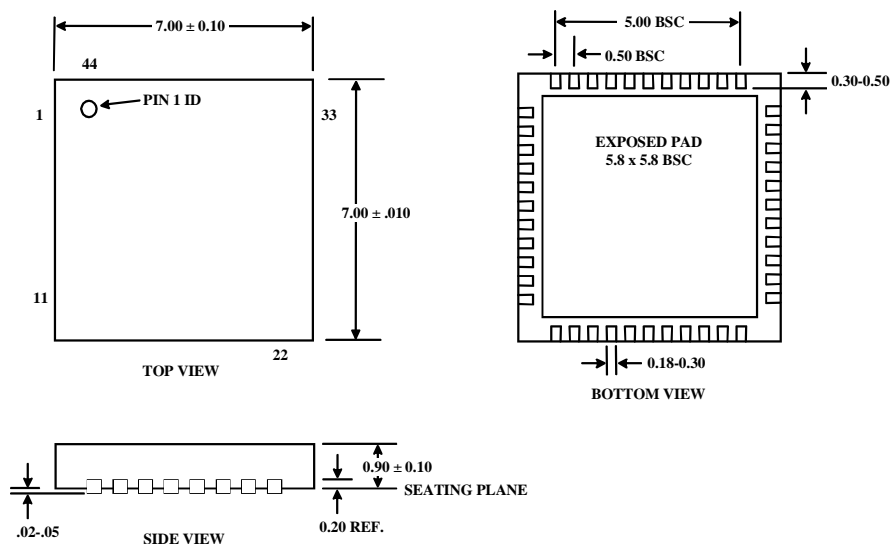

ORDERING INFORMATION

PARTNUMBER	TEMPERATURERANGE	PACKAGE	DATASHEET	PUBLICATIONDATE
ML6652CH	0°C to 70°C	44 Pin TQFP	DS6652-F-02	January, 2004
ML6652EH	-20°C to 85°C	44 Pin TQFP	DS6652-F-02	January, 2004
ML6652CM	0°C to 70°C	44 Pin LPCC/QFN	DS6652-F-02	January, 2004
ML6652EM	-20°C to 85°C	44 Pin LPCC/QFN	DS6652-F-02	January, 2004