



Photocoupler

Product Data Sheet

MOC3052 SERIES

Spec No.: DS70-2001-025

Effective Date: 06/17/2016

Revision: E

LITE-ON DCC

RELEASE

BNS-OD-FC001/A4

Photocoupler MOC305X series

1. DESCRIPTION

1.1 Features

- Isolation voltage between input and output $V_{iso} : 5,000V_{rms}$
- 6pin DIP photocoupler, triac driver output
- High repetitive peak off-state voltage $V_{DRM} : \text{Min. } 600V$
- High critical rate of rise of off-state voltage($dV/dt : \text{MIN. } 1000V / \mu s$)
- Dual-in-line package : MOC3050, MOC3051, MOC3052, MOC3053
- Wide lead spacing package : MOC3050M, MOC3051M, MOC3052M, MOC3053M
- Surface mounting package : MOC3050S, MOC3051S, MOC3052S, MOC3053S
- Tape and reel packaging : MOC3050S-TA, MOC3051S-TA, MOC3052S-TA, MOC3053S-TA
MOC3050S-TA1, MOC3051S-TA1, MOC3052S-TA1, MOC3053S-TA1
- Safety approval
UL 1577, Cert. No.E113898
CSA CA5A, Cert. No. 1020087 (CA 91533-1)
FIMKO EN/IEC 60950-1, EN/IEC 60065; Cert. No.NCS/FI 24426 M3
VDE DIN EN60747-5-2, Cert. No. 40015248
CQC GB4943.1-2011/ GB8898-2011
- RoHS Compliance
All materials be used in device are followed EU RoHS directive (No.2002/95/EC).
- MSL class1

1.2 Applications

- AC Motor Drives
- AC Motor Starters
- E.M. Contactors
- Lighting Controls
- Solenoid/Valve Controls
- Solid State Relays
- Static Power Switches
- Temperature Controls

Photocoupler MOC305X series

2. PACKAGE DIMENSIONS

2.1 MOC305X

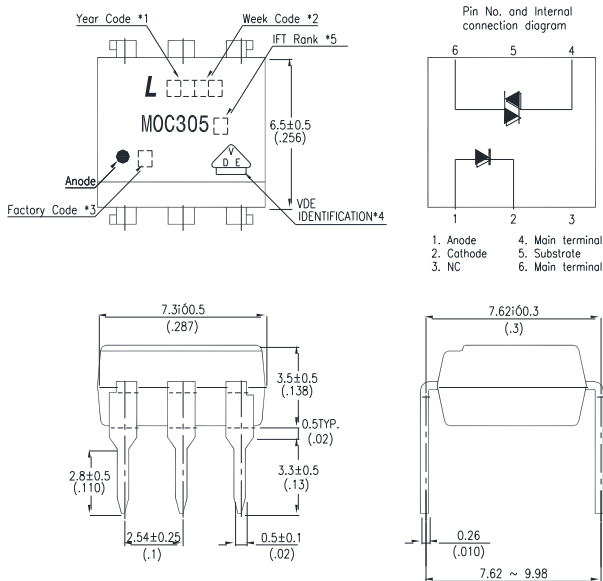

2.2 MOC305XM

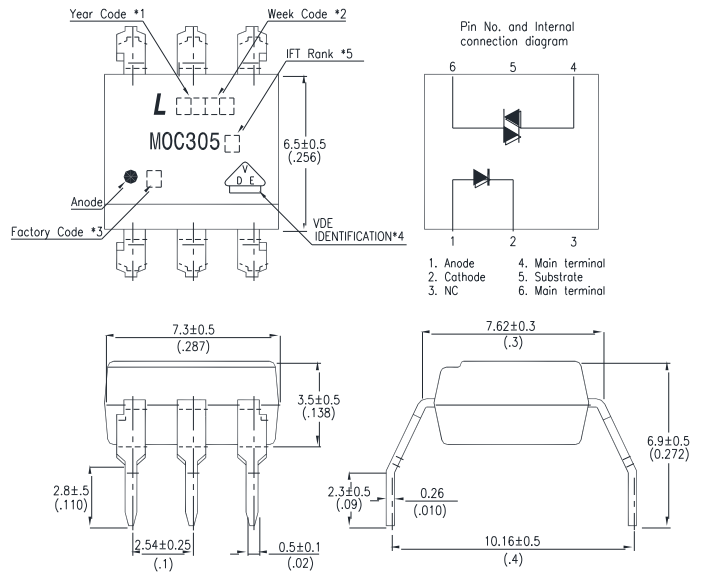

2.3 MOC305XS

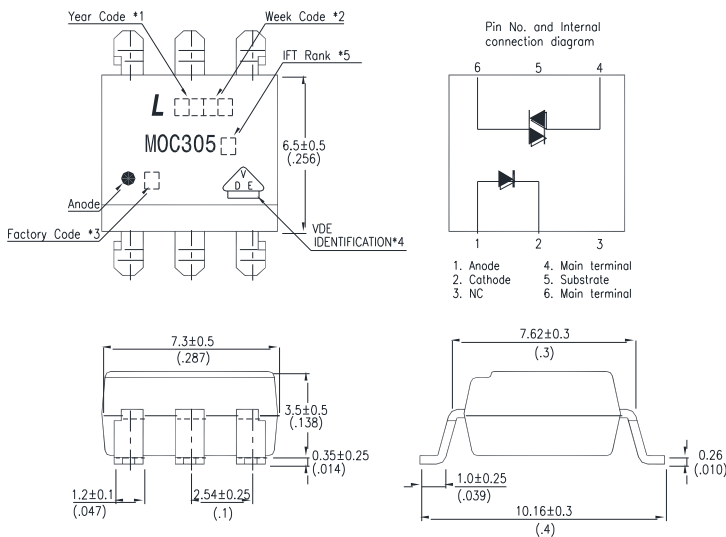

Notes :

1. Year date code.
2. 2-digit work week.
3. Factory identification mark shall be marked (W: China-CZ, Y: Thailand)
4. VDE option
5. I_{FT} rank

* Dimensions are in Millimeters and (Inches).

Photocoupler MOC305X series

3. TAPING DIMENSIONS

3.1 MOC305XS-TA



3.2 MOC305XS-TA1

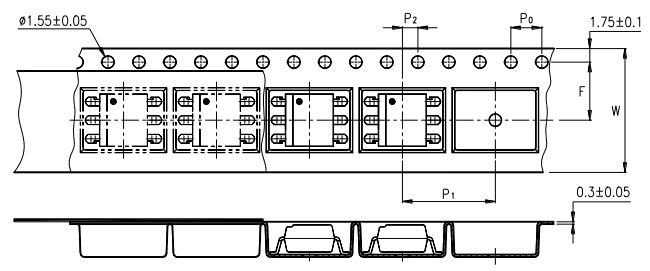

Description	Symbol	Dimension in mm (inch)
Tape wide	W	16±0.3 (0.63)
Pitch of sprocket holes	P ₀	4±0.1 (0.15)
Distance of compartment	F	7.5±0.1 (0.295)
	P ₂	2±0.1 (0.079)
Distance of compartment to compartment	P ₁	12±0.1 (0.472)

3.3 Quantities Per Reel

Package Type	MOC305XS series
Quantities (pcs)	1000

Photocoupler MOC305X series

4. RATING AND CHARACTERISTICS

4.1 Absolute Maximum Ratings at Ta=25°C

	Parameter	Symbol	Rating	Unit
Input	Forward Current	I_F	50	mA
	Reverse Voltage	V_R	6	V
	Junction Temperature	T_J	125	°C
	Power Dissipation	P	100	mW
Output	Off-State Output Terminal Voltage	V_{DRM}	600	V
	Peak Repetitive Surge Current (PW=1ms, 120pps)	I_{TSM}	1	A
	Junction Temperature	T_J	125	°C
	Collector Power Dissipation	P_C	300	mW
	Total Power Dissipation	P_{tot}	330	mW
1.	Isolation Voltage	V_{iso}	5000	V_{rms}
	Operating Temperature	T_{opr}	-40 ~ +100	°C
	Storage Temperature	T_{stg}	-55 ~ +150	°C
2.	Soldering Temperature	T_{sol}	260	°C

1. AC For 1 Minute, R.H. = 40 ~ 60%

Isolation voltage shall be measured using the following method.

- (1) Short between anode and cathode on the primary side and between collector and emitter on the secondary side.
- (2) The isolation voltage tester with zero-cross circuit shall be used.
- (3) The waveform of applied voltage shall be a sine wave.

2. For 10 Seconds

Photocoupler MOC305X series

4.2 ELECTRICAL OPTICAL CHARACTERISTICS at Ta=25°C

Parameter		Symbol	Min.	Typ.	Max.	Unit	Test Condition	
Input	Forward Voltage	V_F	—	1.15	1.5	V	$I_F=20\text{mA}$	
	Reverse Current	I_R	—	0.05	10	μA	$V_R=6\text{V}$	
Output	1 Peak Blocking Current, Either Direction	I_{DRM}	—	10	100	nA	$V_{\text{DRM}} = 600\text{V}$	
	Peak On-State Voltage, Either Direction	V_{TM}	—	1.7	3.0	V	$I_{\text{TM}}=100\text{ mA Peak}$	
	2 Critical rate of Rise of Off-State Voltage	dv/dt	1000	—	—	V/ μs	$V_{\text{in}}=240\text{Vrms}$	
Couple	3 Led Trigger Current, Current Required to Latch Output,	MOC3050	I_{FT}	—	—	30	mA	Main Terminal Voltage = 3V
		MOC3051		—	—	15		
		MOC3052		—	—	10		
		MOC3053		—	—	5		
	Holding Current, Either Direction	I_H	—	200	—	μA		

*1. Test voltage must be applied within dv/dt rating.

*2. This is static dv/dt . Commutating dv/dt is a function of the load-driving thyristor(s) only.

*3. All devices are guaranteed to trigger at an I_F value less than or equal to max I_{FT} . Therefore, recommended operating I_F lies between max I_{FT} , 30 mA for MOC3050, 15 mA for MOC3051, 10 mA for MOC3052, 5 mA for MOC3053, and absolute max I_F (50mA)

Photocoupler MOC305X series

5. CHARACTERISTICS CURVES (TYPICAL PERFORMANCE)

Fig.1 Forward Current vs. Ambient Temperature

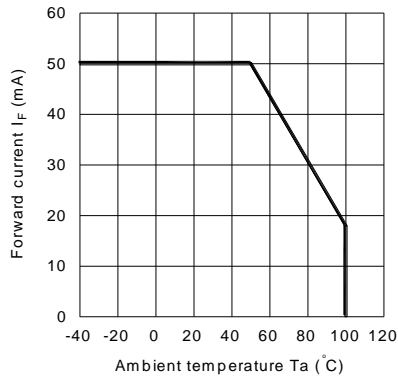

Fig.2 On-state Current vs. Ambient Temperature

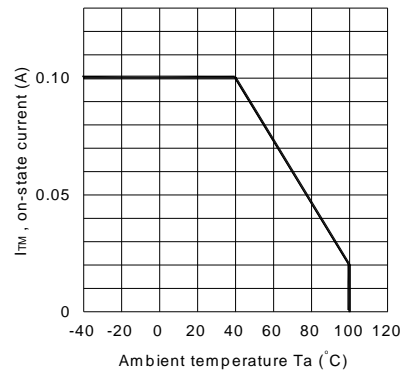

Fig.3 Minimum Trigger Current vs. Ambient Temperature

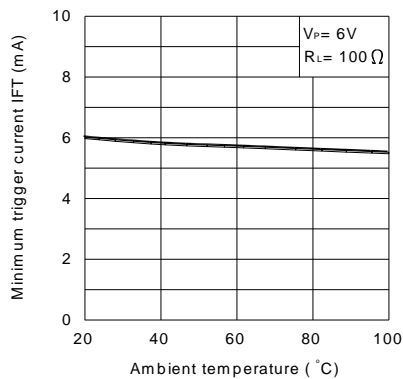

Fig.4 Forward Current vs. Forward Voltage

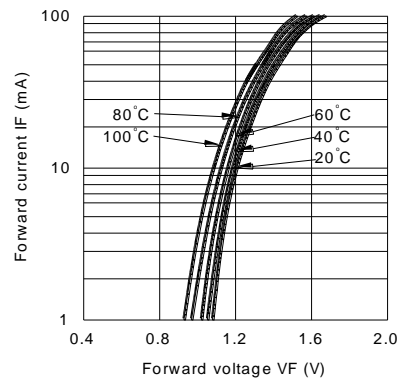

Fig.5 On-state Voltage vs. Ambient Temperature

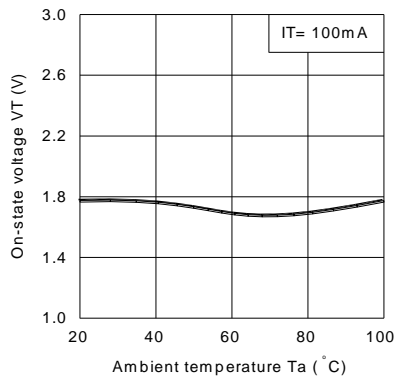
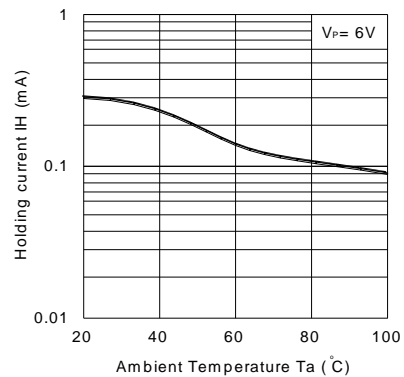

Fig.6 Holding Current vs. Ambient Temperature



Photocoupler MOC305X series

Fig.7 Repetitive Peak Off-state Current vs. Temperature

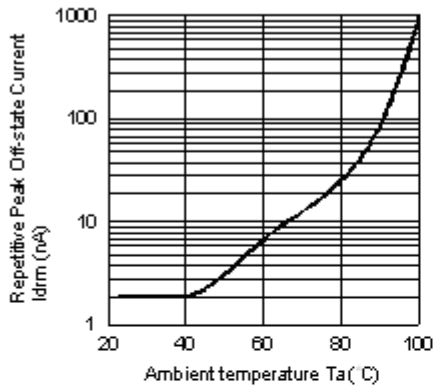
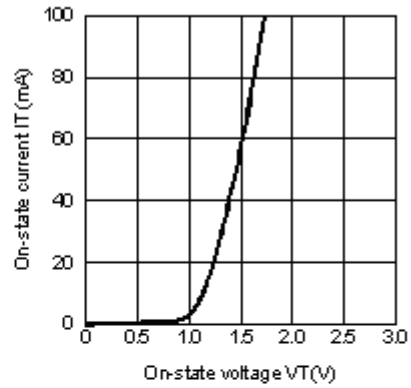
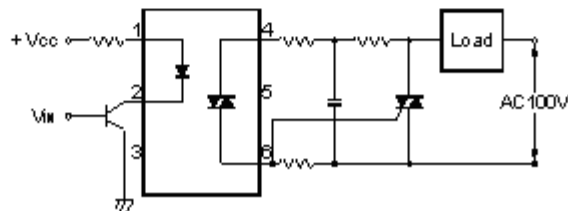

Fig.8 On-state Current vs. On-state Voltage



Basic Operation Circuit
Medium/High Power Triac Drive Circuit



Photocoupler MOC305X series

6. TEMPERATURE PROFILE OF SOLDERING

6.1 IR Reflow soldering (JEDEC-STD-020C compliant)

One time soldering reflow is recommended within the condition of temperature and time profile shown below. Do not solder more than three times.

Profile item	Conditions
Preheat	
- Temperature Min (T_{Smin})	150°C
- Temperature Max (T_{Smax})	200°C
- Time (min to max) (ts)	90±30 sec
Soldering zone	
- Temperature (T_L)	217°C
- Time (t_L)	60 sec
Peak Temperature (T_P)	260°C
Ramp-up rate	3°C / sec max.
Ramp-down rate	3~6°C / sec

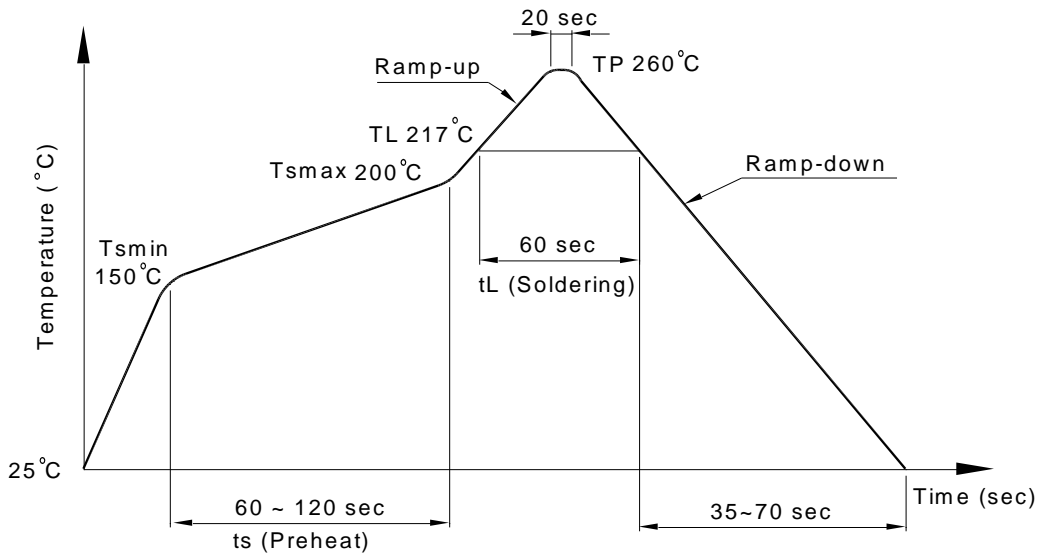

**Photocoupler
MOC305X series**

6.2 Wave soldering (JEDEC22A111 compliant)

One time soldering is recommended within the condition of temperature.

Temperature: $260 \pm 0 / -5^\circ\text{C}$

Time: 10 sec.

Preheat temperature: 25 to 140°C

Preheat time: 30 to 80 sec.

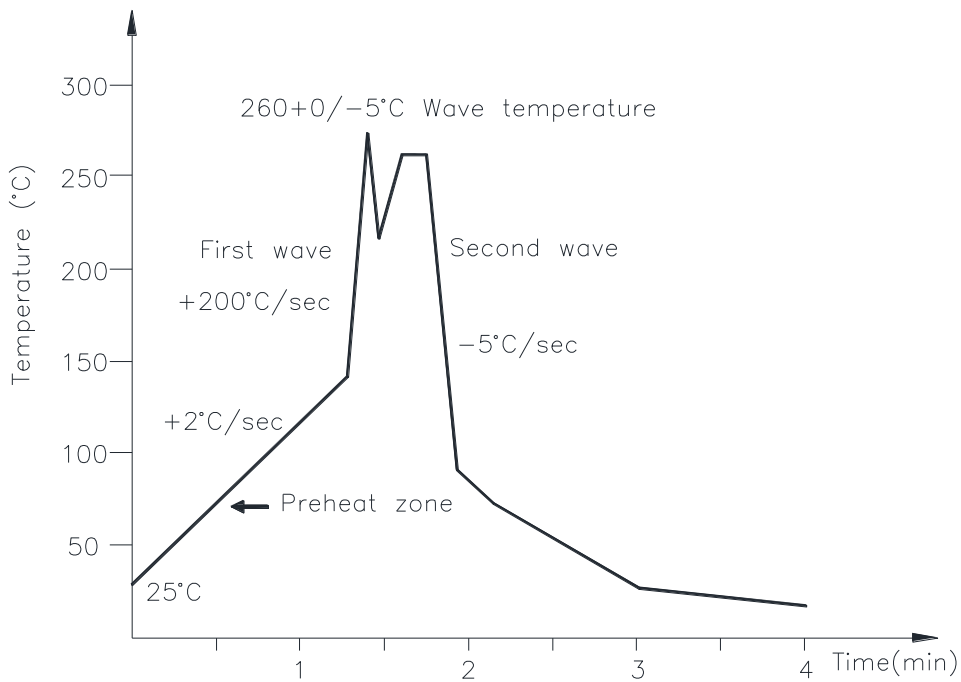

6.3 Hand soldering by soldering iron

Allow single lead soldering in every single process. One time soldering is recommended.

Temperature: $380 \pm 0 / -5^\circ\text{C}$

Time: 3 sec max.

**Photocoupler
MOC305X series**

7. RRECOMMENDED FOOT PRINT PATTERNS (MOUNT PAD)

Unit: mm

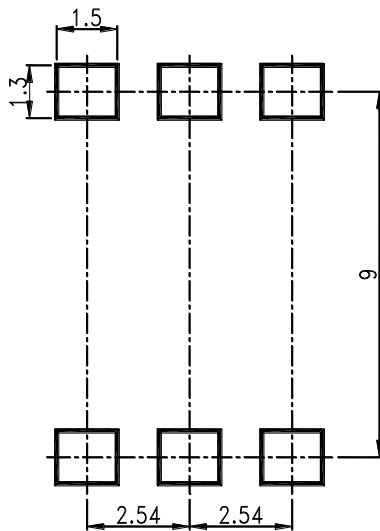

**Photocoupler
MOC305X series**

8. NAMING RULE

MOC305(X)(1)-(2)

DEVICE PART NUMBER (MOC305X)

Please refer to Electrical Optical Characteristics Table on Page P5

(1) FORM TYPE (S, M or none)

(2) TAPING TYPE (TA, TA1)

Example : MOC3051S-TA1

MOC305(X)(1)(2)-V

DEVICE PART NUMBER (MOC305X)

Please refer to Electrical Optical Characteristics Table on Page P5

(1) FORM TYPE (S, M or none)

(2) TAPING TYPE (TA, TA1)

(3) VDE option

Example : MOC3051STA1-V

9. NOTES

- LiteOn is continually improving the quality, reliability, function or design and LiteOn reserves the right to make changes without further notices.
- The products shown in this publication are designed for the general use in electronic applications such as office automation equipment, communications devices, audio/visual equipment, electrical application and instrumentation.
- For equipment/devices where high reliability or safety is required, such as space applications, nuclear power control equipment, medical equipment, etc, please contact our sales representatives.
- When requiring a device for any "specific" application, please contact our sales in advice.
- If there are any questions about the contents of this publication, please contact us at your convenience.
- The contents described herein are subject to change without prior notice.
- Immerge unit's body in solder paste is not recommended.