



128K x 8 SRAM

MSM8128 - 70/85/10/12

Elm Road, West Chirton, NORTH SHIELDS, Tyne & Wear
NE29 8SE, England Tel. +44 (0191) 2930500 Fax. +44 (0191) 2590997

Issue 4.6: June 2002

Description

The MSM8128 is a 1Mbit monolithic SRAM organised as 128K x 8. It is currently available in DIL package with access times of 70, 85, 100, 120ns. It has a low power standby version and has 3.0V battery backup capability. It is directly TTL compatible and has common data inputs and outputs.

Two pinout variants (single and dual \overline{CS}) are available.

All versions may be screened in accordance with MIL-STD-883.

131,072 x 8 CMOS Static RAM

Features

Access Times of 70/85/100/120 ns

JEDEC standard Dual \overline{CS} footprints.

Operating Power 550 mW (max)

Low Power Standby (-L) 2.2 mW (max)

Low Voltage Data Retention.

Completely Static Operation

Directly TTL compatible.

May be processed in accordance with MIL-STD-883

Block Diagram

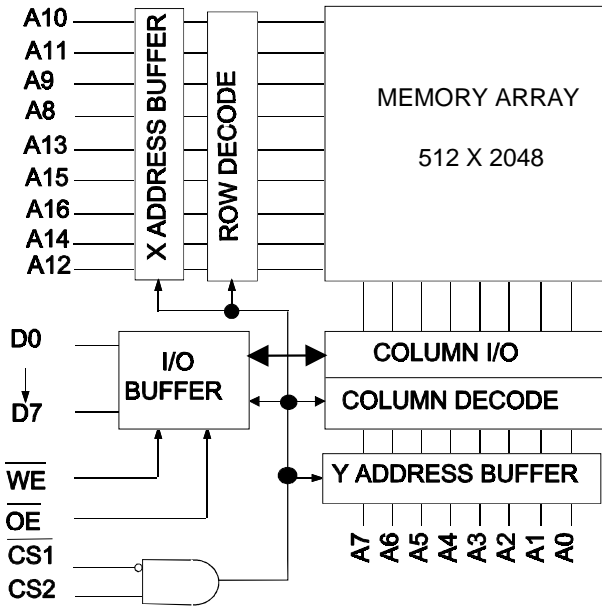

Pin Definition

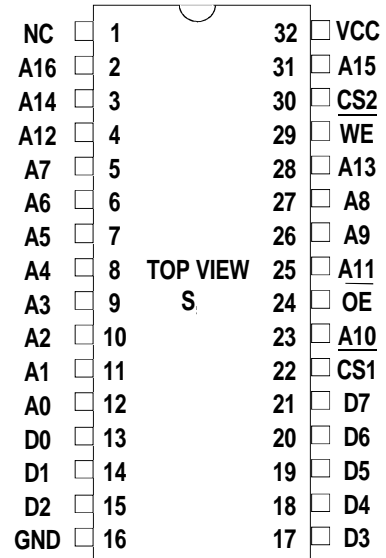

See Page 9 for SX

Pin Functions

- A0-A16** Address Inputs
- D0-7** Data Input/Output
- CS1** Chip Select 1
- CS2** Chip Select 2
- OE** Output Enable
- WE** Write Enable
- NC** No Connect
- V_{cc}** Power (+5V)
- GND** Ground

Package Details

Pin Count	Description	Package Type
32	0.6" Dual-in-Line (DIP)	S

Package details on pages 8 & 9.

DC OPERATING CONDITIONS**Absolute Maximum Ratings**

Voltage on any pin relative to V_{SS}	V_T	-0.5V	to	+7.0	V
Power Dissipation	P_T			1	W
Storage Temperature	T_{STG}	-55	to	+150	°C

Notes : (1) Stresses above those listed may cause permanent damage to the device. This is a stress rating only and functional operation of the device at these or any other conditions above those indicated in the operational sections of this specification is not implied. Exposure to absolute maximum rating conditions for extended periods may affect device reliability.

Recommended Operating Conditions

		<i>min</i>	<i>typ</i>	<i>max</i>	
Supply Voltage	V_{CC}	4.5	5.0	5.5	V
Input High Voltage	V_{IH}	2.2	-	5.8	V
Input Low Voltage	V_{IL}	-0.3	-	0.8	V
Operating Temperature	T_A	0	-	70	°C
	T_{AI}	-40	-	85	°C (I suffix)
	T_{AM}	-55	-	125	°C (M, MB suffix)

DC Electrical Characteristics ($V_{CC} = 5.0V \pm 10\%$, $T_A = -55^\circ\text{C}$ to $+125^\circ\text{C}$)

Parameter	Symbol	Test Condition	<i>min</i>	<i>typ</i>	<i>max</i>	Unit
Input Leakage Current	I_{LI}	$\overline{V_{IH}}=0V$ to V_{CC}	-1	-	1	μA
Output Leakage Current	I_{IO}	$\overline{CS1}=V_{IH}$, $CS2 = V_{IL}$, $V_{IO}=0V$ to V_{CC} , $\overline{OE}=V_{IH}$	-1	-	1	μA
Average Supply Current	I_{CC1}	Min. Cycle, $V_{IN}=V_{IL}$ or V_{IH}	-	-	100	mA
Standby Supply Current	I_{SB1}	$\overline{CS1}=V_{IH}$, $CS2 = V_{IL}$, I/P's static	-	-	3	mA
-L Part	I_{SB2}	$\overline{CS1} \geq V_{CC} - 0.2V$, $0.2V \geq CS2 \geq V_{CC} - 0.2V$, $V_{IN} \geq 0.2V$	-	-	400	μA
Output Voltage	V_{OL}	$I_{OL} = 2.1 \text{ mA}$	-	-	0.4	V
	V_{OH}	$I_{OH} = -1.0 \text{ mA}$	2.4	-	-	V

Capacitance ($V_{CC}=5V \pm 10\%$, $T_A=25^\circ\text{C}$)

Parameter	Symbol	Test Condition	<i>typ</i>	<i>max</i>	Unit
I/P Capacitance	C_{IN}	$V_{IN}=0V$	-	8	pF
I/O Capacitance	C_{IO}	$V_{IO}=0V$	-	10	pF

Note: This parameter is not 100% tested.

Operating Modes

The table below shows the logic inputs required to control the MSM8128 SRAM.

Mode	$\overline{CS1}$	CS2	\overline{OE}	\overline{WE}	V_{CC} Current	I/O Pin	Reference Cycle
Not Selected	1	X	X	X	I_{SB1}, I_{SB2}	High Z	Power Down
Not Selected	X	0	X	X	I_{SB}, I_{SB1}	High Z	Power Down
Output Disable	0	1	1	1	I_{CC}	High Z	
Read	0	1	0	1	I_{CC}	D_{OUT}	Read Cycle
Write	0	1	X	0	I_{CC}	D_{IN}	Write Cycle

1 = V_{IH} , 0 = V_{IL} , X = Don't Care

Low V_{CC} Data Retention Characteristics - L Version Only ($T_A = -55^\circ\text{C}$ to $+125^\circ\text{C}$)

Parameter	Symbol	Test Condition	min	typ	max	Unit
V_{CC} for Data Retention	V_{DR}	$\overline{CS1} \geq V_{CC} - 0.2\text{V}$, $CS2 \geq V_{CC} - 0.2\text{V}$ or $0\text{V} \leq CS2 \leq 0.2\text{V}$, $V_{IN} \geq 0\text{V}$	2.0	-	-	V
Data Retention Current	I_{CCDR}	$V_{CC} = 3.0\text{V}$, $V_{IN} \geq 0\text{V}$, $\overline{CS1} \geq V_{CC} - 0.2\text{V}$, $CS2 \geq V_{CC} - 0.2\text{V}$ or $0\text{V} \leq CS2 \leq 0.2\text{V}$.	-	-	600	μA
Chip Deselect to Data Retention	t_{CDR}	See Retention Waveform	0	-	-	ns
Operation Recovery Time	t_R	See Retention Waveform	5	-	-	ms

Notes (1) CS2 controls address buffer, WE buffer, $\overline{CS1}$ buffer and \overline{OE} buffer. If CS2 controls data retention mode, V_{in} levels ($\overline{WE}, \overline{OE}, \overline{CS1}, I/O$) can be in the high impedance state. If CS1 controls Data Retention mode, CS2 must be $\geq V_{CC} - 0.2\text{V}$ or $0\text{V} \leq CS2 \leq 0.2\text{V}$. The other input levels (address, $\overline{WE}, \overline{OE}, I/O$) can be in the high impedance state.

AC Test Conditions

Output Load

- * Input pulse levels: 0V to 3.0V
- * Input rise and fall times: 5ns
- * Input and Output timing reference levels: 1.5V
- * Output load: See Load Diagram
- * $V_{CC} = 5\text{V} \pm 10\%$

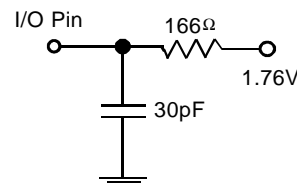

AC OPERATING CONDITIONS**Read Cycle**

Parameter	Symbol	70		85		10		12		Unit
		min	max	min	max	min	max	min	max	
Read Cycle Time	t_{RC}	70	-	85	-	100	-	120	-	ns
Address Access Time	t_{AA}	-	70	-	85	-	100	-	120	ns
Chip Select ($\overline{CS1}$) Access Time ⁽²⁾	t_{ACS1}	-	70	-	85	-	100	-	120	ns
Chip Select ($\overline{CS2}$) Access Time ⁽²⁾	t_{ACS2}	-	70	-	85	-	100	-	120	ns
Output Enable to Output Valid	t_{OE}	-	35	-	45	-	50	-	60	ns
Output Hold from Address Change	t_{OH}	5	-	5	-	10	-	10	-	ns
Chip Selection ($\overline{CS1}$) to Output in Low Z	t_{CLZ1}	10	-	10	-	10	-	10	-	ns
Chip Selection ($\overline{CS2}$) to Output in Low Z	t_{CLZ2}	10	-	10	-	10	-	10	-	ns
Output Enable to Output in Low Z	t_{OLZ}	5	-	5	-	5	-	5	-	ns
Chip Disable ($\overline{CS1}$) to Output in High Z ⁽³⁾	t_{CHZ1}	0	35	0	35	0	35	0	45	ns
Chip Disable ($\overline{CS2}$) to Output in High Z ⁽³⁾	t_{CHZ2}	0	35	0	35	0	35	0	45	ns
Output Disable to Output in High Z ⁽³⁾	t_{OHZ}	0	30	0	30	0	35	0	45	ns

Write Cycle

Parameter	Symbol	70		85		10		12		Unit
		min	max	min	max	min	max	min	max	
Write Cycle Time	t_{WC}	70	-	85	-	100	-	120	-	ns
Chip Selection to End of Write	t_{CW}	60	-	75	-	85	-	100	-	ns
Address Valid to End of Write	t_{AW}	60	-	75	-	85	-	100	-	ns
Address Setup Time	t_{AS}	0	-	0	-	0	-	0	-	ns
Write Pulse Width	t_{WP}	50	-	60	-	70	-	70	-	ns
Write Recovery Time (\overline{WE} , $\overline{CS1}$)	t_{WR1}	5	-	5	-	5	-	5	-	ns
($\overline{CS2}$)	t_{WR2}	5	-	5	-	5	-	5	-	ns
Write to Output in High Z	t_{WHZ}	0	30	0	30	0	35	0	40	ns
Data to Write Time Overlap	t_{DW}	30	-	35	-	40	-	45	-	ns
Data Hold from Write Time	t_{DH}	0	-	0	-	0	-	0	-	ns
Output Active from End of Write	t_{OW}	5	-	5	-	5	-	5	-	ns

Read Cycle Timing Waveform ^(1,2)

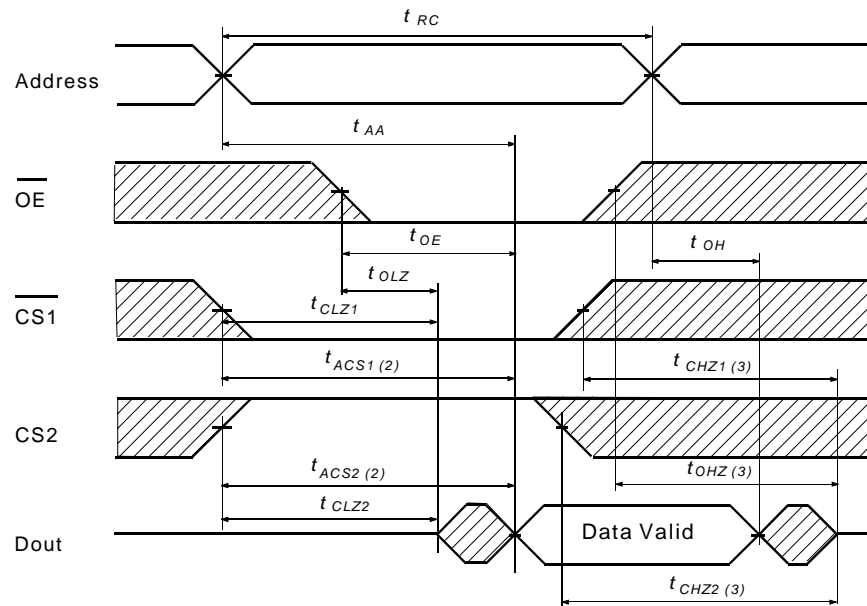

Notes:

- (1) \overline{WE} is High for Read Cycle.
- (2) Address valid prior to or coincident with $\overline{CS1}$ transition low or CS2 high.
- (3) t_{CHZ} and t_{OHZ} are defined as the time at which the outputs achieve the open circuit conditions and are not referenced to output voltage levels. At any given temperature and voltage condition, t_{CHZ} max is less than t_{CLZ} min both for a given device and from device to device. This parameter is sampled and not 100% tested.

Write Cycle No.1 Timing Waveform

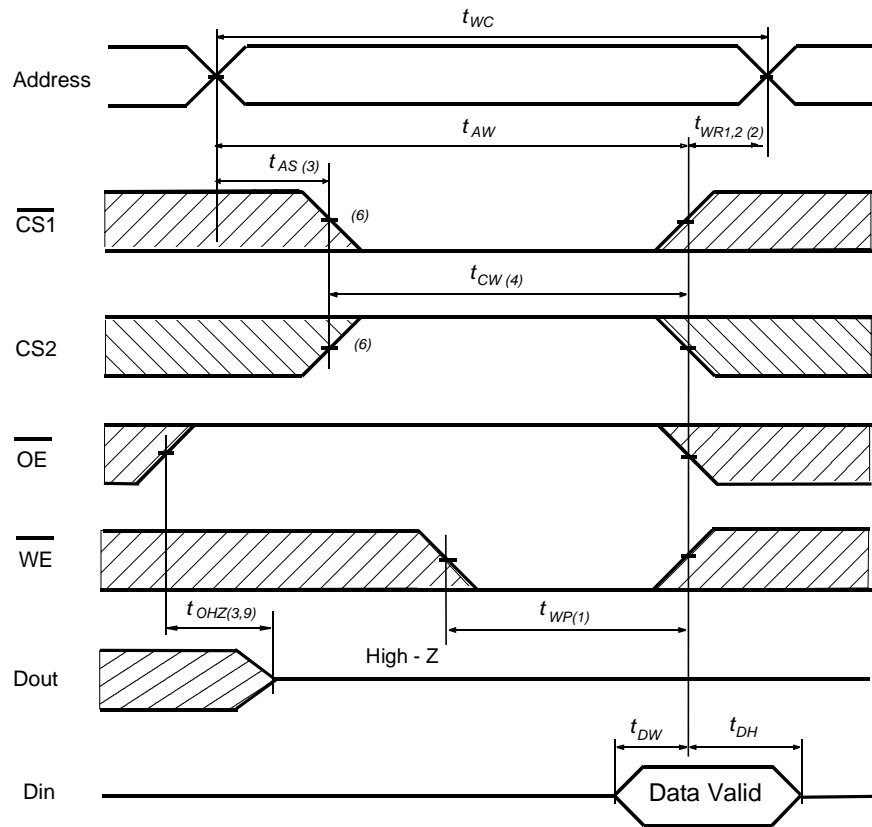

Write Cycle No.2 Timing Waveform ⁽⁵⁾

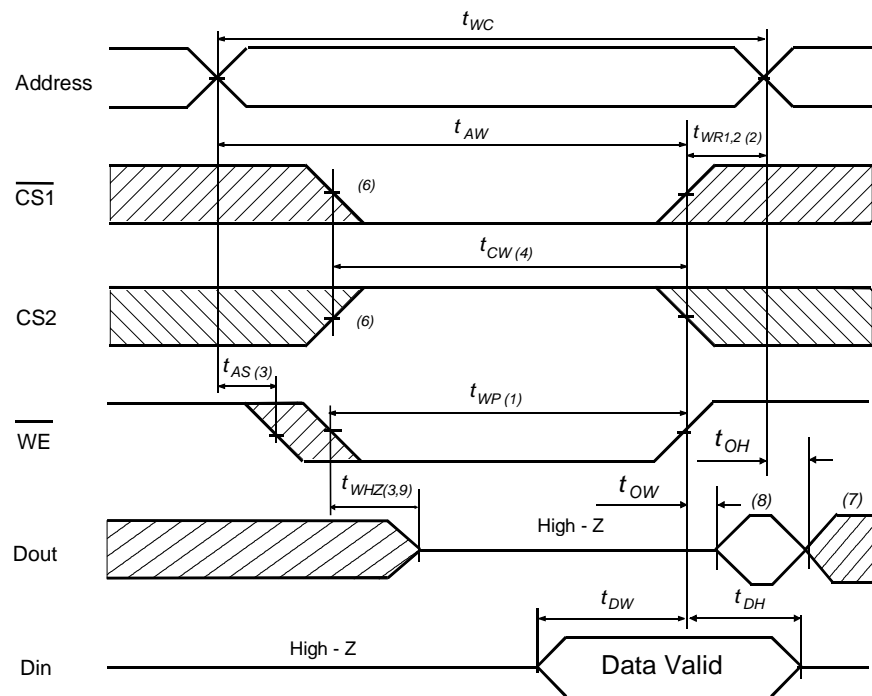

Low V_{CC} Data Retention Timing Waveform 1 ($\overline{CS1}$ controlled)

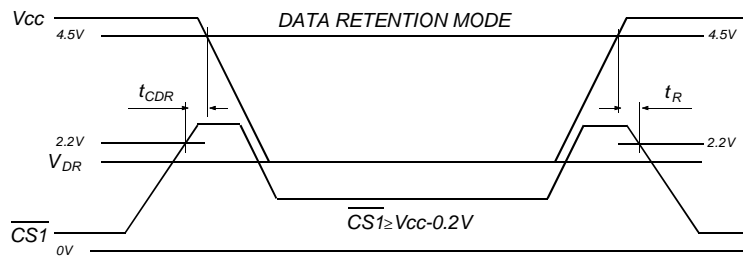

Low V_{CC} Data Retention Timing Waveform 2 (CS2 controlled)

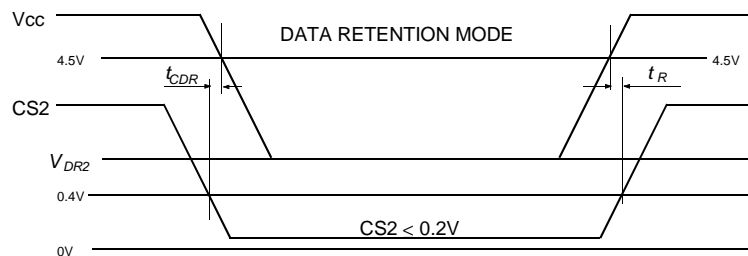

AC Characteristics Notes

- (1) A write occurs during the overlap of a low $\overline{CS1}$, a high CS2 and a low \overline{WE} . A write begins at the latest transition among $\overline{CS1}$ going low, CS2 going high and \overline{WE} going low. A write ends at the earliest transition among $\overline{CS1}$ going high, CS2 going low and \overline{WE} going high. t_{WP} is measured from the beginning of write to the end of write.
- (2) t_{WR} is measured from the earlier of $\overline{CS1}$ or \overline{WE} going high or CS2 going high to the end of write cycle.
- (3) During this period, I/O pins are in the output state. Input signals out of phase must not be applied.
- (4) If $\overline{CS1}$ goes low simultaneously with \overline{WE} going low or after \overline{WE} going low, outputs remain in high impedance state.
- (5) OE is continuously low. ($\overline{OE} = V_{IL}$)
- (6) Dout is in the same phase as written data of this write cycle.
- (7) Dout is the read data of next address.
- (8) If $\overline{CS1}$ is low and CS2 is high during this period, I/O pins are in the output state. Input signals out of phase must not be applied to I/O pins.
- (9) t_{WHZ} is defined as the time at which the outputs achieve the open circuit conditions and is not referenced to output voltage levels. These parameters are sampled and not 100% tested.

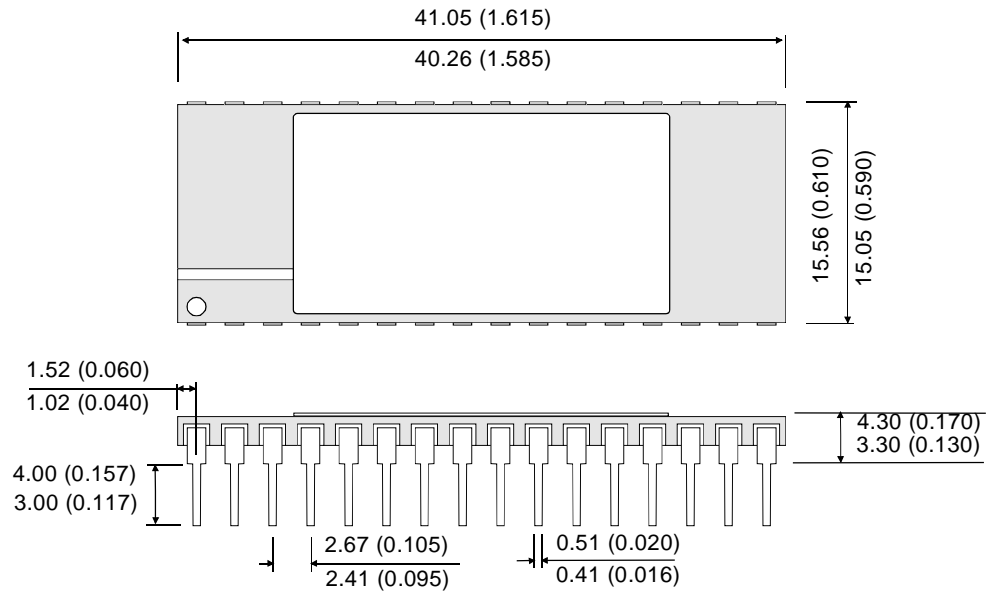
Package Details**32 pin 0.6" Dual-in-Line (DIP) - 'S' Package**

All dimensions in mm (inches).

Alternate Pin Definition

NC	□	1		32	□	VCC
A16	□	2		31	□	A15
A14	□	3		30	□	NC
A12	□	4		29	□	\overline{WE}
A7	□	5		28	□	A13
A6	□	6		27	□	A8
A5	□	7		26	□	A9
A4	□	8	TOP VIEW	25	□	A11
A3	□	9	SX	24	□	\overline{OE}
A2	□	10		23	□	A10
A1	□	11		22	□	\overline{CS}
A0	□	12		21	□	D7
D0	□	13		20	□	D6
D1	□	14		19	□	D5
D2	□	15		18	□	D4
GND	□	16		17	□	D3

Military Screening Procedure

Component Screening Flow for high reliability product is in accordance with Mil-883 method 5004

MB COMPONENT SCREENING FLOW		
<i>SCREEN</i>	<i>TEST METHOD</i>	<i>LEVEL</i>
Visual and Mechanical		
Internal visual	2010 Condition B or manufacturers equivalent	100%
Temperature cycle	1010 Condition C (10 Cycles, -65°C to +150°C)	100%
Constant acceleration	2001 Condition E (Y, only) (30,000g)	100%
Pre-Burn-in electrical	Per applicable device specifications at $T_A=+25^\circ\text{C}$	100%
Burn-in	Method 1015, Condition D, $T_A=+125^\circ\text{C}$, 160hrs min	100%
Final Electrical Tests	Per applicable Device Specification	
Static (dc)	a) @ $T_A=+25^\circ\text{C}$ and power supply extremes	100%
	b) @ temperature and power supply extremes	100%
Functional	a) @ $T_A=+25^\circ\text{C}$ and power supply extremes	100%
	b) @ temperature and power supply extremes	100%
Switching (ac)	a) @ $T_A=+25^\circ\text{C}$ and power supply extremes	100%
	b) @ temperature and power supply extremes	100%
Percent Defective allowable (PDA)	Calculated at post-burn-in at $T_A=+25^\circ\text{C}$	5%
Hermeticity	1014	
Fine	Condition A	100%
Gross	Condition C	100%
External Visual	2009 Per vendor or customer specification	100%

Ordering Information

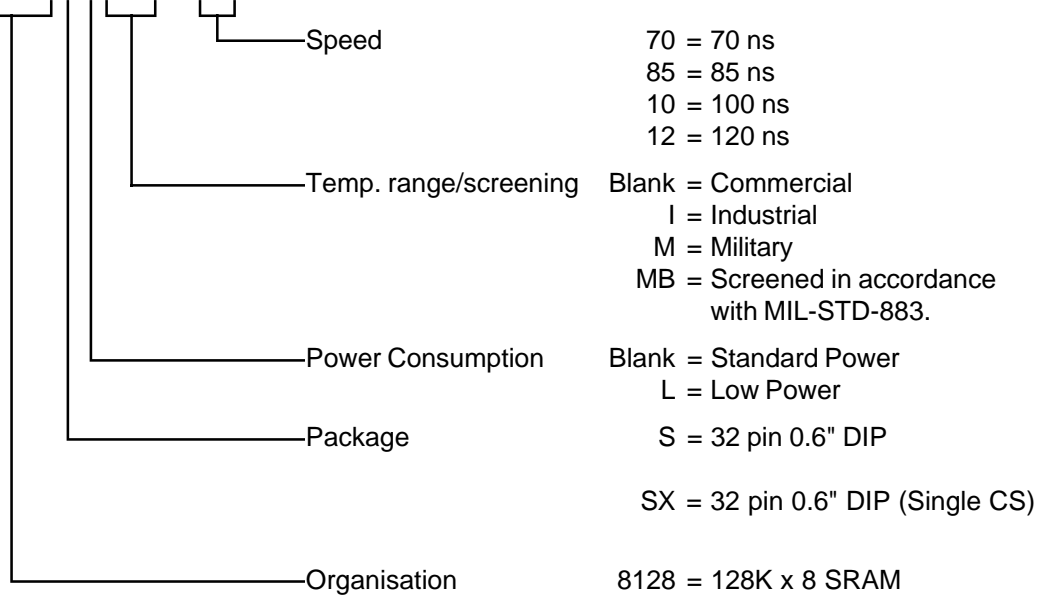
MSM8128SLMB - 70

Although this data is believed to be accurate the information contained herein is not intended to and does not create any warranty of merchantability or fitness for a particular purpose.

Our products are subjected to a constant process of development. Data may be changed at any time without notice. Products are not authorised for use as critical components in life support devices without the express written approval of a company director.