

## Precision Metal Film Resistors



### FEATURES

- 0.063 W to 0.5 W at 70 °C
- Approved according to CECC 40101
- Wide ohmic range from 1 Ω to 4.7 MΩ
- Good initial precision up to ± 0.1 %
- Operating temperatures:
  - 55 °C to + 155 °C for TCR ≥ 25 ppm/°C
  - 25 °C to + 85 °C for TCR ≤ 15 ppm/°C
- Epoxy coating
- Termination: Pure matt tin
- Compliant to RoHS directive 2002/95/EC



**RoHS**  
COMPLIANT

### DIMENSIONS in millimeters

TYPE	Ø D max.	L max.	A ± 1	Ø d	CC e	MAX. UNIT WEIGHT
N.. 3..	1.8	3.9	53	0.5	5.08	0.15 g
N.. 4..	2.5	6.2	53	0.6	NA	0.3 g
N.. 5..	3.3	8.7	53	0.6	NA	0.5 g

### TECHNICAL SPECIFICATIONS

MODEL	NT3S	NP3S	NY3	NK3	NT4S	NP4S	NY4	NK4	NT5S	NP5S	NY5	NK5	
Power Rating, $P_r$ at + 70 °C	0.125 W	0.25 W			0.25 W	0.5 W			0.5 W				
Stability Class	1 %			2 %	1 %			2 %	1 %				
Preferred Standard Ohmic Values Series	E192 for 0.1 %/0.25 %/0.5 % E96 for 1 %			E24	E192 for 0.1 %/0.25 %/0.5 % E96 for 1 %			E24	E192 for 0.1 %/0.25 %/0.5 % E96 for 1 %				
Ohmic Value Range in Relation to: Temperature Coefficient, TCR/ Tolerance	± 15 ppm/°C <sup>(1)</sup>	± 0.1 %	100 Ω	-	-	-	49.9 Ω	-	-	-	100 Ω	-	-
		± 0.25 %	200 kΩ	-	-	-	499 kΩ	-	-	-	499 kΩ	-	-
		± 0.5 %	10 Ω	-	-	-	10 Ω	-	-	-	10 Ω	-	-
		± 1 %	200 kΩ	-	-	-	499 kΩ	-	-	-	499 kΩ	-	-
	± 25 ppm/°C <sup>(2)</sup>	± 0.1 %	-	100 Ω	-	-	10 Ω	-	-	-	100 Ω	-	-
		± 0.25 %	-	511 kΩ	-	-	1 MΩ	-	-	-	1 MΩ	-	-
		± 0.5 %	-	10 Ω	-	-	10 Ω	-	-	-	10 Ω	-	-
		± 1 %	-	511 kΩ	-	-	1 MΩ	-	-	-	1 MΩ	-	-
	± 50 ppm/°C <sup>(2)</sup>	± 0.1 %	-	-	-	-	-	10 Ω	-	-	-	10 Ω	-
		± 0.25 %	-	-	-	-	-	1 MΩ	-	-	-	1 MΩ	-
		± 0.5 %	-	-	10 Ω	-	-	10 Ω	-	-	-	10 Ω	-
		± 1 %	-	-	1.5 MΩ	-	-	3.32 MΩ	-	-	-	4.7 MΩ	-
± 100 ppm/°C <sup>(2)</sup>	± 2 %	-	-	1 Ω	-	-	10 Ω	-	-	-	2.67 Ω	-	
	± 5 %	-	-	1.5 MΩ	-	-	3.32 MΩ	-	-	-	4.7 MΩ	-	
Limiting Element Voltage $U_{max. RMS}$	200 V				350 V				350 V				
Critical Resistance	-	-	160 kΩ	490 kΩ	245 kΩ			245 kΩ					
Thermal Resistance	170 °C/W				145 °C/W				110 °C/W				

**Notes**

- <sup>(1)</sup> TCR requirement for temperature between - 25 °C and + 85 °C  
<sup>(2)</sup> TCR requirement for temperature between - 55 °C and + 125 °C



ENVIRONMENTAL SPECIFICATIONS												
MODEL	NT3S	NP3S	NY3	NK3	NT4S	NP4S	NY4	NK4	NT5S	NP5S	NY5	NK5
Temperature Range	- 25 °C to + 85 °C	- 55 °C to + 155 °C			- 25 °C to + 85 °C	- 55 °C to + 155 °C			- 25 °C to + 85 °C	- 55 °C to + 155 °C		
Climatic Category (LCT/UCT/days)	-	55/125/56			-	55/125/56			-	55/125/56		

OFFICIAL APPROVAL LIST						
MODEL	SPECIFICATION	NATIONAL REFERENCE	CECC REFERENCE	QUALIFIED RANGE	TOLERANCE	P <sub>r</sub> at 70 °C
NY3	CECC 40101-002	RS 59Y	EY	10 Ω 301 kΩ	± 1 %	0.125 W
	CECC 40101-002	RS 48Y	AY			0.063 W
	CECC 40101-803	-	AC			0.063 W
NK3	CECC 40101-001	RC 9	DU	10 Ω 510 kΩ	± 2 % ± 5 %	0.250 W
	CECC 40101-001	RC 8U	AU			0.125 W
	CECC 40101-802	-	AV			0.125 W
NP4S	CECC 40101-002	RS 64P	FP	100 Ω 1 MΩ	± 0.5 % ± 1 %	0.250 W
	CECC 40101-002	RS 58P	BP			0.125 W
NY4	CECC 40101-002	RS 71Y	GY	10 Ω 1 MΩ	± 0.5 % ± 1 %	0.500 W
	CECC 40101-002	RS 64Y	FY			0.250 W
	CECC 40101-002	RS 58Y	BY			0.125 W
	CECC 40101-803	-	BC			0.125 W
NK4	CECC 40101-001	RC 32	EU	10 Ω 1 MΩ	± 2 % ± 5 %	0.500 W
	CECC 40101-001	RC 21U	BU			0.250 W
	CECC 40101-802	-	BV			0.250 W
NY5	CECC 40101-002	RS 69Y	HY	10 Ω 1 MΩ	± 0.5 % ± 1 %	0.500 W
	CECC 40101-002	RS 63Y	CY			0.250 W
	CECC 40101-803	-	CC			0.250 W
NK5	CECC 40101-001	RC 31U	CU	10 Ω 1 MΩ	± 2 % ± 5 %	0.500 W
	CECC 40101-802	-	CV			

PERFORMANCE				
TEST	CONDITIONS	REQUIREMENTS		TYPICAL DRIFT
		STABILITY CLASS 1 CECC 40101-002/803	STABILITY CLASS 2 CECC 40101-001/802	
Short Time Overload	IEC 60115-1 6.25 $P_r$ or 2 $U_{max}$ . 1 s for 0.063 W/5 s for $\geq 0.125$ W	$\pm (0.25 \% + 0.05 \Omega)$	$\pm (0.5 \% + 0.05 \Omega)$	$\leq \pm 0.05 \%$
Load Life	IEC 60115-1 90'/30' cycles. 1000 h at $P_r/70$ °C	$\pm (1 \% + 0.05 \Omega)$	$\pm (2 \% + 0.1 \Omega)$	$\leq \pm 0.25 \%$
Load Life at Maximum Category Temperature	IEC 60115-1 90'/30' cycles 1000 h at derated $P_r/125$ °C	$\pm (1 \% + 0.05 \Omega)$	$\pm (2 \% + 0.1 \Omega)$	$\leq \pm 0.25 \%$
	IEC 60115-1 1000 h at 155 °C	-	-	
Sheft Life	1 year at ambient temperature	-	-	$\leq \pm 0.1 \%$
Seq. A1 Robustness of Terminations	IEC 60115-1 IEC 60068-2-21 Test Ua1: Traction 10N/10 s Test Ub: Bending + 90° → - 90° → 0° with 5N Test Uc: Twisting 2 times at 180°	$\pm (0.25 \% + 0.05 \Omega)$	$\pm (0.5 \% + 0.05 \Omega)$	$\leq \pm 0.1 \%$
Seq. A2 Resistance to Soldering Heat	IEC 60115-1 IEC 60068-2-20 Test Tb Method 1: Solder bath 260 °C/10 s	$\pm (0.25 \% + 0.05 \Omega)$	$\pm (0.5 \% + 0.05 \Omega)$	$\leq \pm 0.05 \%$
Seq. B1 Rapid Change of Temperature	IEC 60115-1 IEC 60068-2-14 Test Na 5 cycles (30' at LCT/30' at UCT) - 55 °C/125 °C	$\pm (0.25 \% + 0.05 \Omega)$	$\pm (0.5 \% + 0.05 \Omega)$	$\leq \pm 0.05 \%$
Seq. B2 Vibration	IEC 60115-1 IEC 60068-2-6 Test Fc 10 Hz/500 Hz	$\pm (0.25 \% + 0.05 \Omega)$	$\pm (0.5 \% + 0.05 \Omega)$	$\leq \pm 0.1 \%$
Seq. A + B Climatic Sequence	IEC 60115-1 1. Dry heat at 125 °C/16 h (IEC 60068-2-2) 2. Damp heat 55 °C/24 h (IEC 60068-2-30 Test Db) 3. Cold at - 55 °C/2 h (IEC 60068-2-1 Test Aa) 4. Low pressure 25 °C/1 h (IEC 60068-2-13) 5. Damp heat 55 °C/120 h (IEC 60068-2-30 Test Db)	$\pm (1 \% + 0.05 \Omega)$	$\pm (2 \% + 0.1 \Omega)$	$\leq \pm 0.25 \%$
Damp Heat, Steady State	IEC 60115-1 IEC 60068-2-78 40 °C/93 % RH/56 days	$\pm (1 \% + 0.05 \Omega)$	$\pm (2 \% + 0.1 \Omega)$	$\leq \pm 0.5 \%$

**POWER RATING CHARTS**

CECC 40101-001/40101-802 NK3/NK4/NK5

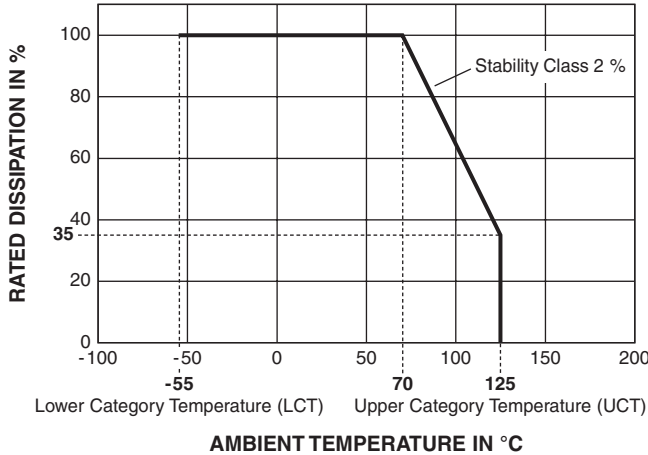

CECC 40101-002/40101-803 NY3/NY4/NP4S/NY5

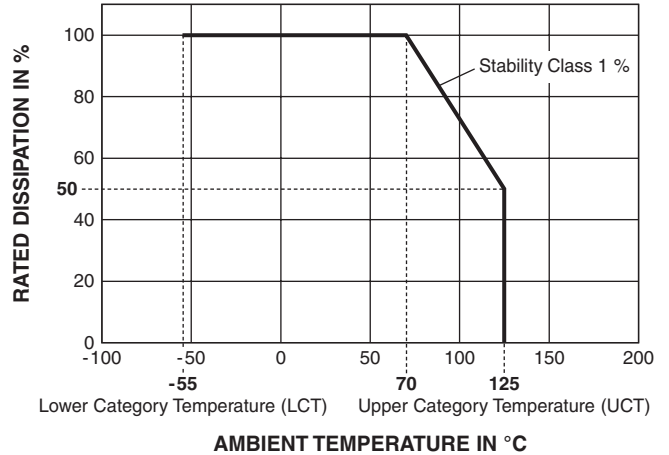

**HIGH FREQUENCY**

Typical behavior for NK4

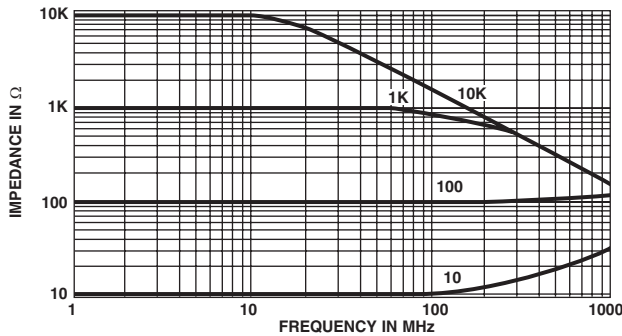

**MARKING**

Resistor color code chart 6, 5 or 4 bands.

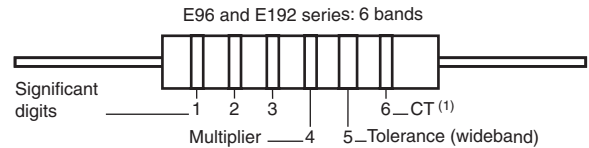

**Note**

(1) Only for TCR ≤ 25 ppm/°C

**THIRD HARMONIC**

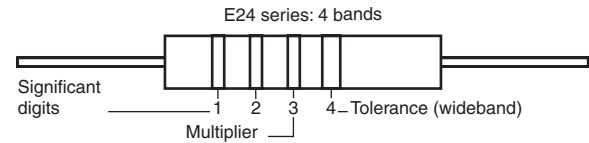
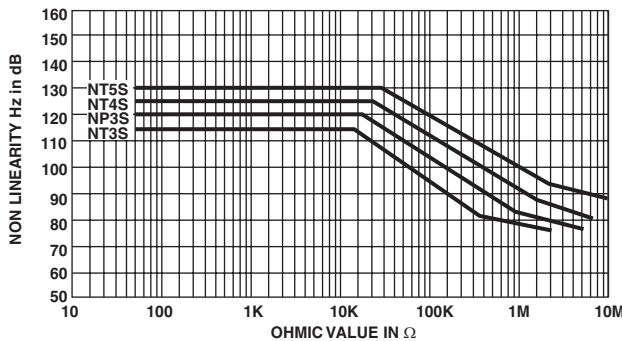

**NOISE**

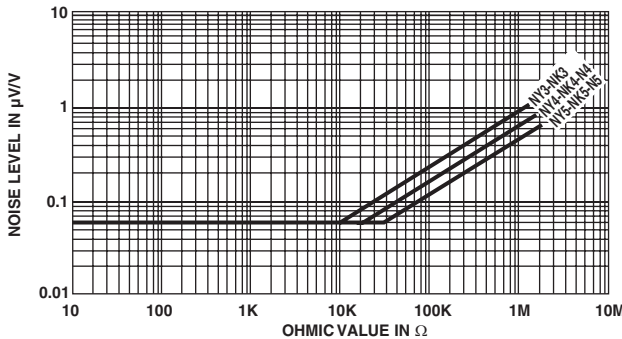

COLOR	DIGIT.	MULTIP.	TOL %	CT ppm/°C
Black	0	1		
Brown	1	10	1	
Red	2	10 <sup>2</sup>	2	
Orange	3	10 <sup>3</sup>		± 15
Yellow	4	10 <sup>4</sup>		± 25
Green	5	10 <sup>5</sup>	0.5	
Blue	6	10 <sup>6</sup>	0.25	± 10
Purple	7	10 <sup>7</sup>	0.1	± 5
Grey	8	10 <sup>8</sup>		
White	9	10 <sup>9</sup>		
Silver		10 <sup>-2</sup>		
Gold		10 <sup>-1</sup>	5	

TAPE IN REEL	
SERIES AND MODEL	QUANTITY PER REEL
NT4S/NP4S	5000
NK4/NY4	5000
SL3	5000
SL4	5000

TAPED IN AMMOPACK		
SERIES AND MODEL	QUANTITY PER BOX	BOX DIMENSIONS L x l x H (mm)
NT3S/NP3S	500	260 x 80 x 26
NY3	500	
NK3/SL3	1000	
NT4S/NP4S	500	
NY4	500	
NK4/SL4	1000	260 x 80 x 37
NT5S/NP5S	500	260 x 85 x 28
NK5	500	

TAPED IN BAG		
SERIES AND MODEL	QUANTITY PER BAG	BAG DIMENSIONS (mm)
NP3S/NT3S	100	85 x 140
NP4S/NT4S		
NP5S/NT5S		
NY3 CC/NK3 CC	500	

## PACKAGING

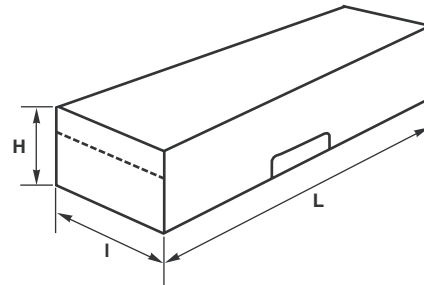
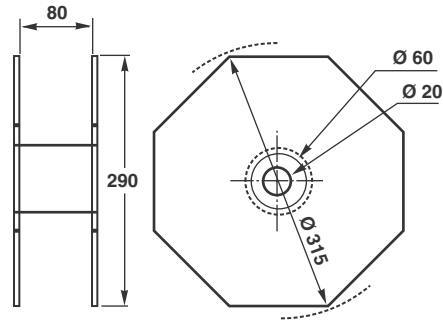
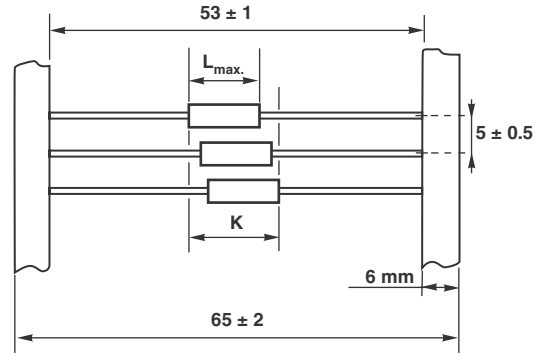

The resistors are required to be inside a window which is the K dimension.

K being equal to the maximum body length of the resistor + 1.4 mm and being centered as per IEC 60286-1 and EIA-296 specification to the tape edges.

ORDERING INFORMATION					
T3	XXX	100 kΩ	1 %	AM1000	e3
MODEL	CUSTOM DESIGN	OHMIC VALUE	TOLERANCE	PACKAGING	LEAD (Pb)-FREE

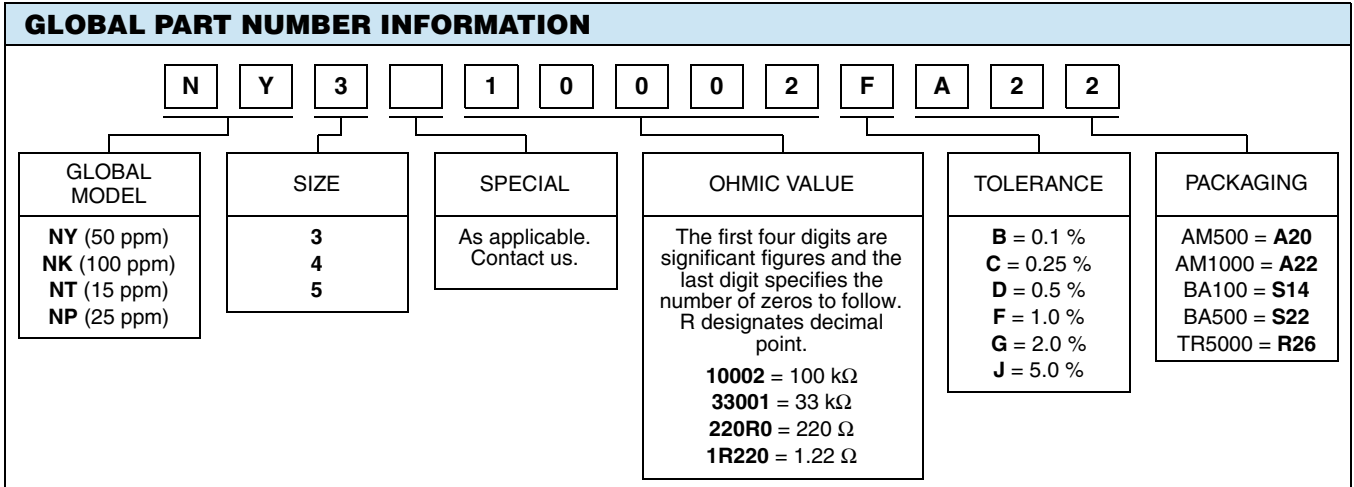



## Disclaimer

All product specifications and data are subject to change without notice.

Vishay Intertechnology, Inc., its affiliates, agents, and employees, and all persons acting on its or their behalf (collectively, "Vishay"), disclaim any and all liability for any errors, inaccuracies or incompleteness contained herein or in any other disclosure relating to any product.

Vishay disclaims any and all liability arising out of the use or application of any product described herein or of any information provided herein to the maximum extent permitted by law. The product specifications do not expand or otherwise modify Vishay's terms and conditions of purchase, including but not limited to the warranty expressed therein, which apply to these products.

No license, express or implied, by estoppel or otherwise, to any intellectual property rights is granted by this document or by any conduct of Vishay.

The products shown herein are not designed for use in medical, life-saving, or life-sustaining applications unless otherwise expressly indicated. Customers using or selling Vishay products not expressly indicated for use in such applications do so entirely at their own risk and agree to fully indemnify Vishay for any damages arising or resulting from such use or sale. Please contact authorized Vishay personnel to obtain written terms and conditions regarding products designed for such applications.

Product names and markings noted herein may be trademarks of their respective owners.