

NICHIA CORPORATION

SPECIFICATIONS FOR WHITE LED

NSSW206AT

- Pb-free Reflow Soldering Application
- RoHS Compliant

SPECIFICATIONS

(1) Absolute Maximum Ratings

Item	Symbol	Absolute Maximum Rating	Unit
Forward Current	I_F	35	mA
Pulse Forward Current	I_{FP}	100	mA
Reverse Voltage	V_R	5	V
Power Dissipation	P_D	115	mW
Operating Temperature	T_{opr}	-30~85	°C
Storage Temperature	T_{stg}	-40~100	°C
Junction Temperature	T_J	105	°C

* Absolute Maximum Ratings at $T_A=25^{\circ}\text{C}$.

* I_{FP} conditions with pulse width $\leq 10\text{ms}$ and duty cycle $\leq 10\%$.

(2) Initial Electrical/Optical Characteristics

Item	Symbol	Condition	Typ	Unit	
Forward Voltage	V_F	$I_F=20\text{mA}$	3.0	V	
Luminous Flux	Φ_v	$I_F=20\text{mA}$	7.7	lm	
Luminous Intensity	I_v	$I_F=20\text{mA}$	2.4	cd	
Chromaticity Coordinate	x	-	$I_F=20\text{mA}$	0.300	-
	y	-	$I_F=20\text{mA}$	0.295	-

* Characteristics at $T_A=25^{\circ}\text{C}$.

* Luminous Flux value as per CIE 127:2007 standard.

* Chromaticity Coordinates as per CIE 1931 Chromaticity Chart.

RANKS

Item	Rank	Min	Max	Unit
Forward Voltage	-	2.6	3.3	V
Reverse Current	-	-	50	μA
Luminous Flux	NW825	8.25	8.50	lm
	NW800	8.00	8.25	
	NW775	7.75	8.00	
	NW750	7.50	7.75	
	NW725	7.25	7.50	
	NW700	7.00	7.25	
	NW675	6.75	7.00	
	NW650	6.50	6.75	
NW625	6.25	6.50		

Color Ranks

	Rank Sa52			
x	0.2800	0.2720	0.2820	0.2880
y	0.2480	0.2580	0.2720	0.2620

	Rank Sa56			
x	0.2830	0.2800	0.2880	0.2910
y	0.2440	0.2480	0.2620	0.2580

	Rank Sa57		
x	0.2720	0.2793	0.2820
y	0.2580	0.2755	0.2720

	Rank Sa62			
x	0.2880	0.2820	0.2910	0.2960
y	0.2620	0.2720	0.2870	0.2760

	Rank Sa66			
x	0.2910	0.2880	0.2960	0.2980
y	0.2580	0.2620	0.2760	0.2710

	Rank Sa67			
x	0.2820	0.2793	0.2887	0.2910
y	0.2720	0.2755	0.2916	0.2870

	Rank Sbj2			
x	0.2960	0.2910	0.2990	0.3040
y	0.2760	0.2870	0.3010	0.2900

	Rank Sbj6			
x	0.2980	0.2960	0.3040	0.3062
y	0.2710	0.2760	0.2900	0.2853

	Rank Sbj7			
x	0.2910	0.2887	0.2968	0.2990
y	0.2870	0.2916	0.3058	0.3010

	Rank Sbk2			
x	0.3040	0.2990	0.3070	0.3120
y	0.2900	0.3010	0.3150	0.3040

	Rank Sbk6			
x	0.3062	0.3040	0.3120	0.3142
y	0.2853	0.2900	0.3040	0.2993

	Rank Sbk7			
x	0.2990	0.2968	0.3048	0.3070
y	0.3010	0.3058	0.3198	0.3150

	Rank Sbm2			
x	0.3120	0.3070	0.3150	0.3200
y	0.3040	0.3150	0.3290	0.3180

	Rank Sbm6			
x	0.3142	0.3120	0.3200	0.3222
y	0.2993	0.3040	0.3180	0.3133

	Rank Sbm7			
x	0.3070	0.3048	0.3128	0.3150
y	0.3150	0.3198	0.3338	0.3290

- * Ranking at $T_A=25^{\circ}\text{C}$.
 - * Reverse Current at $V_R=5\text{V}$.
 - * Tolerance of measurements of the Forward Voltage is $\pm 0.05\text{V}$.
 - * Tolerance of measurements of the Luminous Flux is $\pm 7\%$.
 - * Tolerance of measurements of the Chromaticity Coordinate is ± 0.005 .
 - * A shipment shall consist of LEDs in a combination of the above ranks.
- The percentage of each rank in the shipment shall be determined by Nichia.

Luminous Flux Ranks by Color Rank

Ranking by Color Coordinates	Ranking by Luminous Flux									
	NW625	NW650	NW675	NW700	NW725	NW750	NW775	NW800	NW825	
Sa52,Sa56,Sa57,Sa62,Sa66,Sa67										
Sa62,Sa66,Sa67,Sbj2,Sbj6,Sbj7										
Sbj2,Sbj6,Sbj7,Sbk2,Sbk6,Sbk7										
Sbk2,Sbk6,Sbk7,Sbm2,Sbm6,Sbm7										

CHROMATICITY DIAGRAM

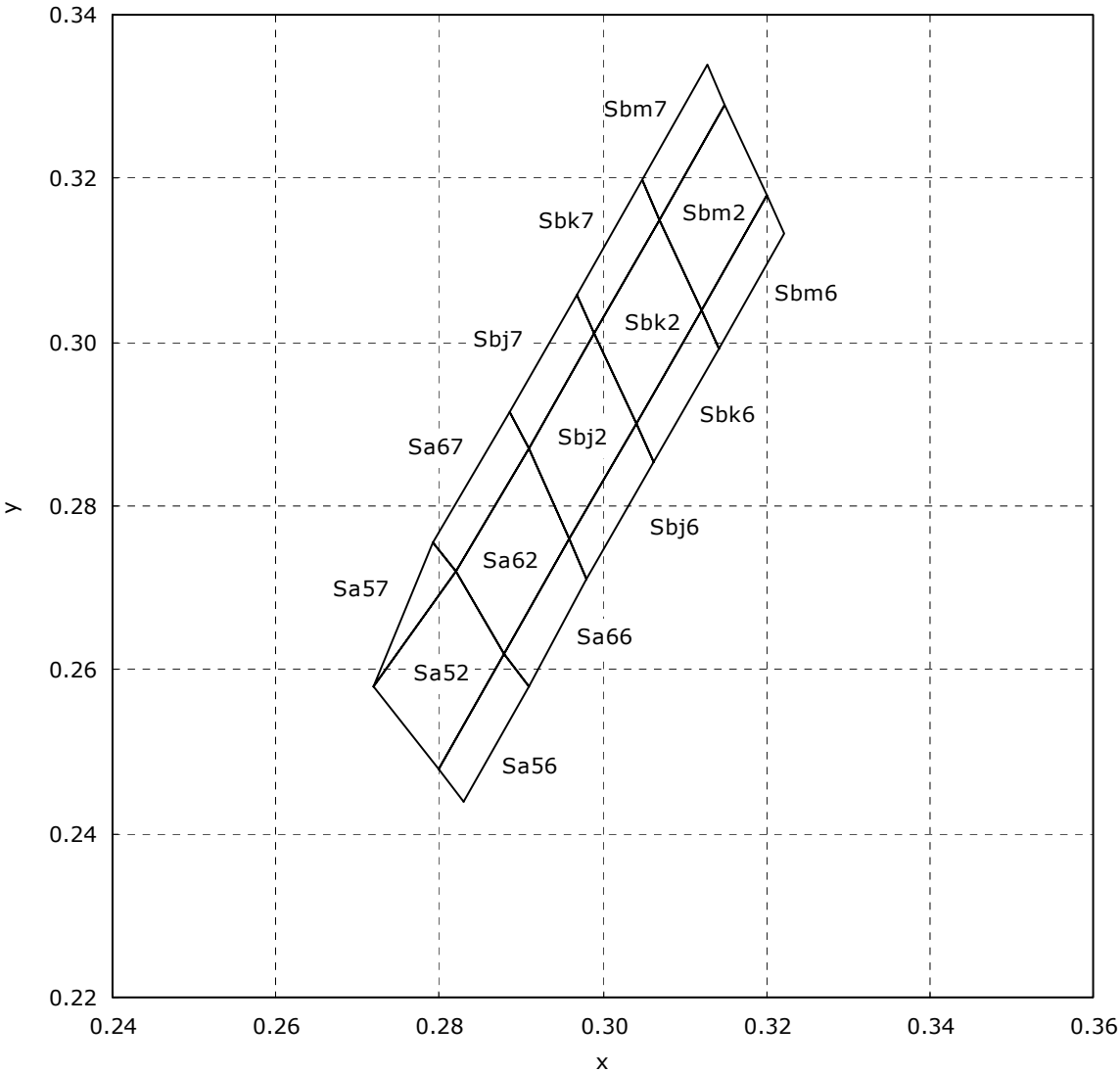

OUTLINE DIMENSIONS

* 本製品はRoHS指令に適合しております。
This product complies with RoHS Directive.

NSSW206x
管理番号 No. STS-DA7-0442A

(単位 Unit: mm, 公差 Tolerance: ±0.1)

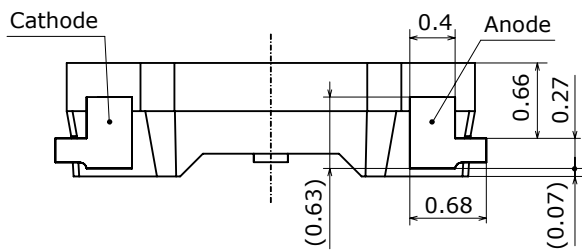
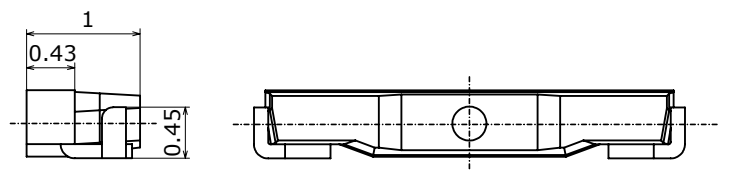
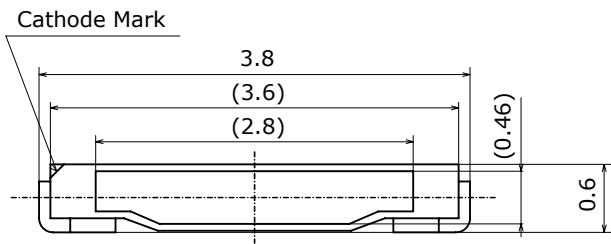
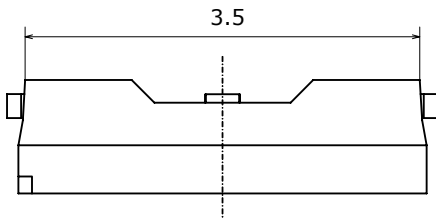

項目 Item	内容 Description
パッケージ材質 Package Materials	耐熱性ポリマー Heat-Resistant Polymer
封止樹脂材質 Encapsulating Resin Materials	シリコン樹脂 (拡散剤+蛍光体入り) Silicone Resin (with diffuser and phosphor)
電極材質 Electrodes Materials	銅合金+銀メッキ Ag-plated Copper Alloy
質量 Weight	0.0043g(TYP)

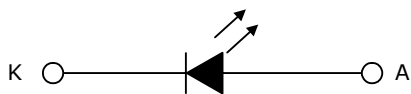

* バリは寸法に含まないものとします。
Dimensions do not include mold flash or metal burr.

SOLDERING

• Recommended Reflow Soldering Condition(Lead-free Solder)

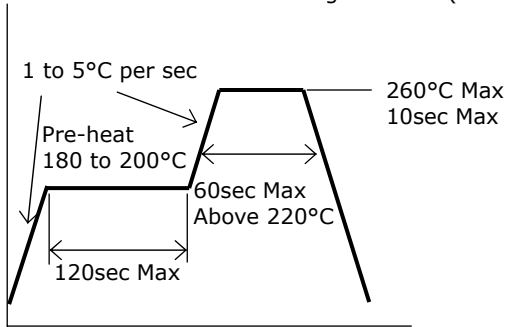

• Recommended Hand Soldering Condition

Temperature	350°C Max
Soldering Time	3sec Max

• Recommended Soldering Pad Pattern

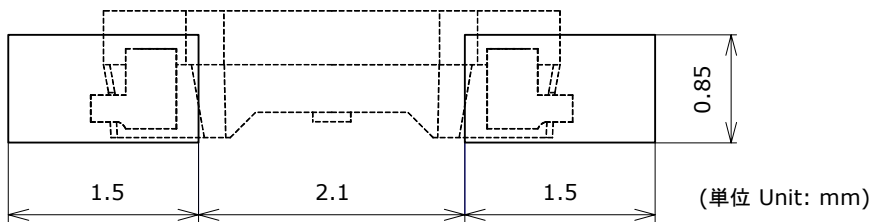

- * This LED is designed to be reflow soldered on to a PCB. If dip soldered, Nichia cannot guarantee its reliability.
- * Reflow soldering must not be performed more than twice. Hand soldering must not be performed more than once.
- * Avoid rapid cooling. Ramp down the temperature gradually from the peak temperature.
- * Nitrogen reflow soldering is recommended. Air flow soldering conditions can cause optical degradation, caused by heat and/or atmosphere.
- * Repairing should not be done after the LEDs have been soldered. When repairing is unavoidable, a double-head soldering iron should be used.
It should be confirmed beforehand whether the characteristics of the LEDs will or will not be damaged by repairing.
- * When soldering, do not apply stress to the LED while the LED is hot.

TAPE AND REEL DIMENSIONS

テーピング部 Tape

Nxxx206x
管理番号 No. STS-DA7-0148

(単位 Unit: mm)

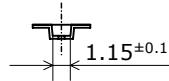
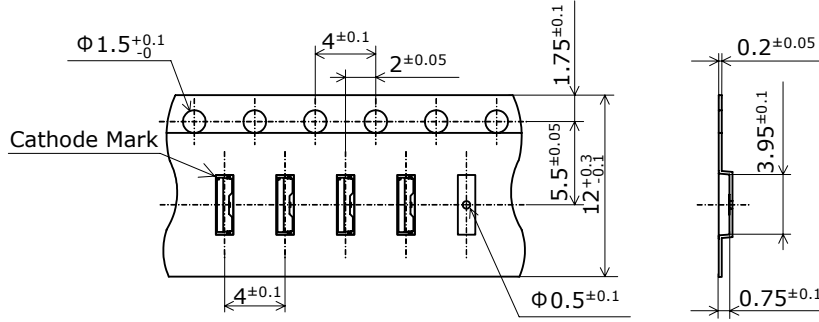

エンボスキャリアテープ
Embossed Carrier Tape

トレーラ部/リーダ部 Trailer and Leader

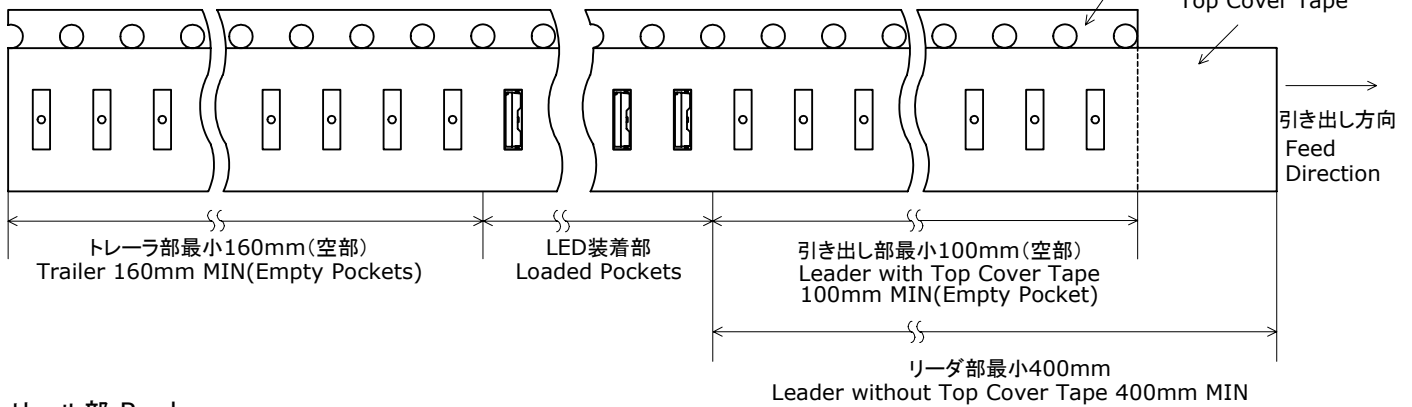

リール部 Reel

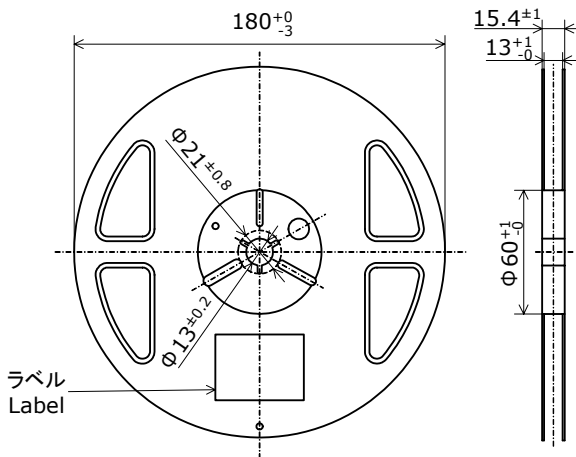

* 数量は1リールにつき 5000個入りです。
Quantity per reel=5000pcs

* JIS C 0806電子部品テーピングに準拠しています。
The tape packing method complies with JIS C 0806
(Packaging of Electronic Components on Continuous Tapes).

PACKAGING - TAPE & REEL

シリカゲルとともにリールをアルミ防湿袋に入れ、熱シールにより封をします。
Reels are shipped with desiccants in heat-sealed moisture-proof bags.

Nxxxxxxx
管理番号 No. STS-DA7-0006B

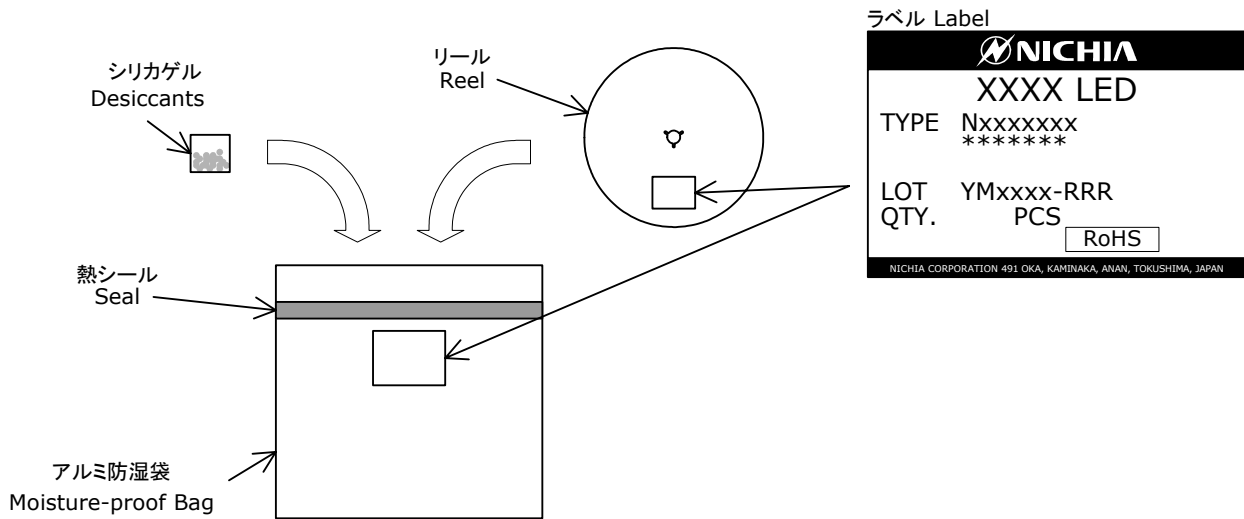

アルミ防湿袋を並べて入れ、ダンボールで仕切ります。
Moisture-proof bags are packed in cardboard boxes with corrugated partitions.

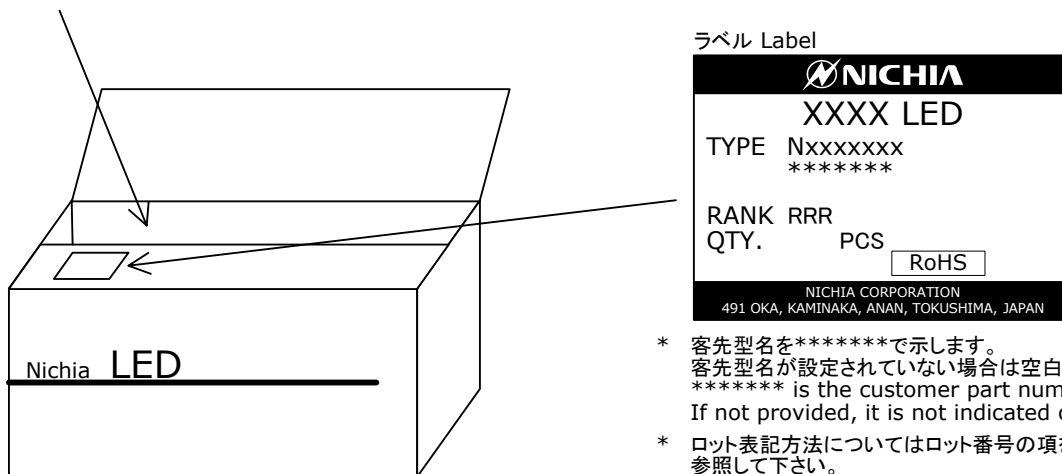

- * 客先型名を*****で示します。
客先型名が設定されていない場合は空白です。
***** is the customer part number.
If not provided, it is not indicated on the label.
- * ロット表記方法についてはロット番号の項を参照して下さい。
For details, see "LOT NUMBERING SCHEME" in this document.
- * ランク分けがない場合はランク表記はありません。
The label does not have the RANK field for un-ranked products.

- * 本製品はテーピングしたのち、輸送の衝撃から保護するためダンボールで梱包します。
Products shipped on tape and reel are packed in a moisture-proof bag.
They are shipped in cardboard boxes to protect them from external forces during transportation.
- * 取り扱いに際して、落下させたり、強い衝撃を与えたりしますと、製品を損傷させる原因になりますので注意して下さい。
Do not drop or shock the box. It may damage the products.
- * ダンボールには防水加工がされておりませんので、梱包箱が水に濡れないよう注意して下さい。
Do not expose to water, the box is not water-resistant.
- * 輸送、運搬に際して弊社よりの梱包状態あるいは同等の梱包を行って下さい。
Using an original packaging material or equivalent in transit is recommended.

LOT NUMBERING SCHEME

Lot Number is presented by using the following alphanumeric code.

YMxxxx - RRR

Y - Year

Year	Y
2009	9
2010	A
2011	B
2012	C
2013	D
2014	E

M - Month

Month	M	Month	M
1	1	7	7
2	2	8	8
3	3	9	9
4	4	10	A
5	5	11	B
6	6	12	C

xxxx-Nichia's Product Number

RRR-Ranking by Color Coordinates, Ranking by Luminous Flux

DERATING CHARACTERISTICS

NxSx206x
 管理番号 No. STS-DA7-1263A

周囲温度-許容順電流特性
 Ambient Temperature vs
 Allowable Forward Current

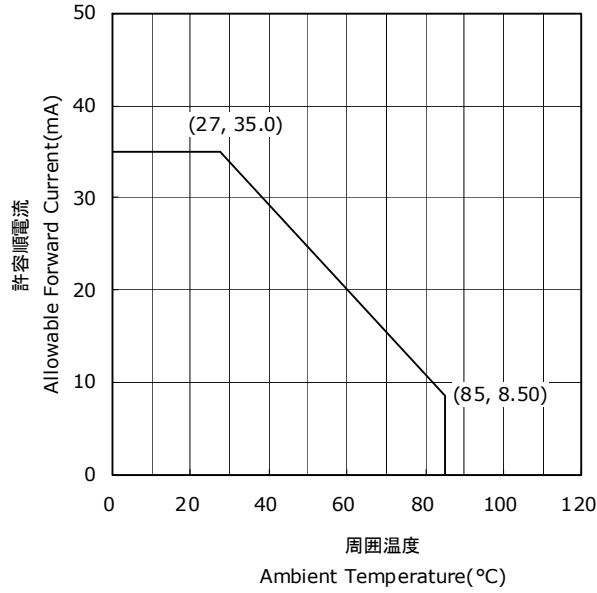

デューティー比-許容順電流特性
 Duty Ratio vs
 Allowable Forward Current

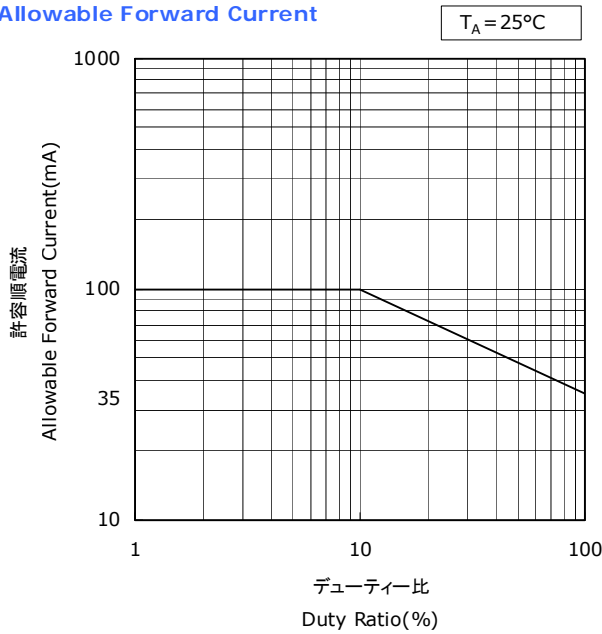

OPTICAL CHARACTERISTICS

* 本特性は参考です。
All characteristics shown are for reference only and are not guaranteed.

NxSW206x
管理番号 No. STS-DA7-1264A

発光スペクトル Spectrum

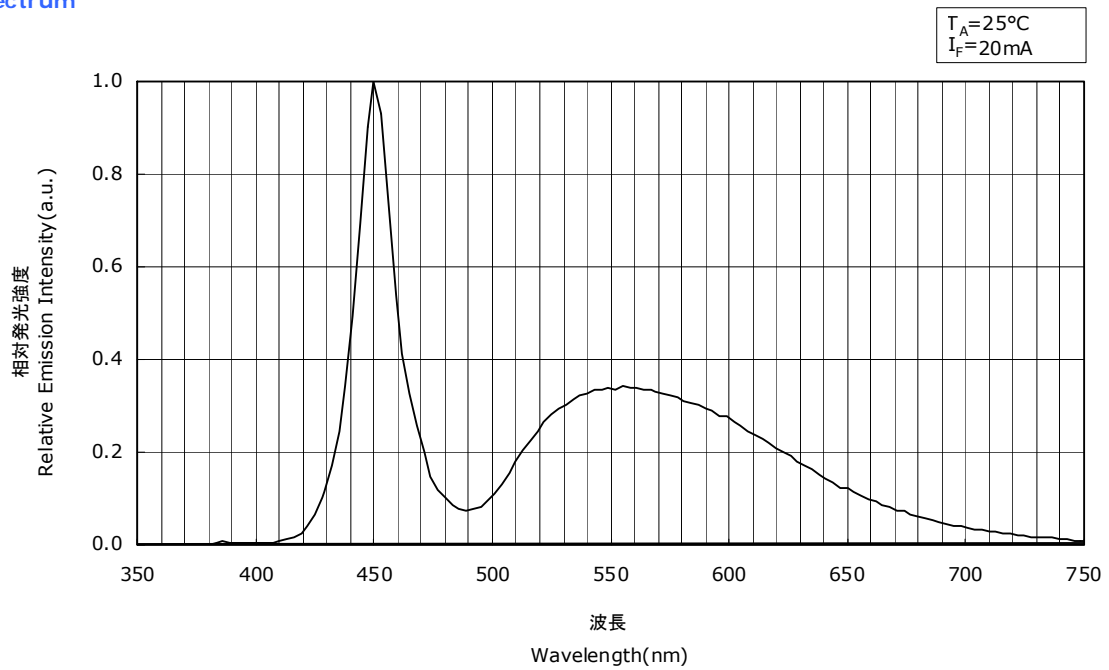

指向特性 Directivity

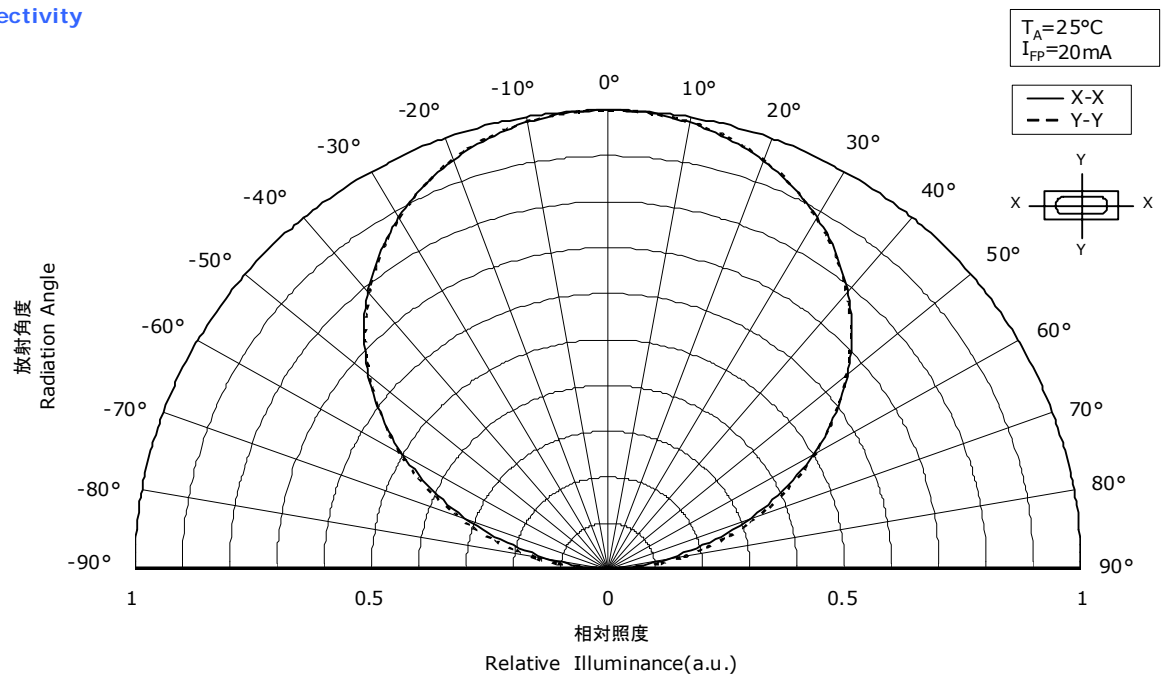

FORWARD CURRENT CHARACTERISTICS / TEMPERATURE CHARACTERISTICS

* 本特性は参考です。
All characteristics shown are for reference only and are not guaranteed.

NxSW206x
管理番号 No. STS-DA7-1265A

順電圧-順電流特性
Forward Voltage vs
Forward Current

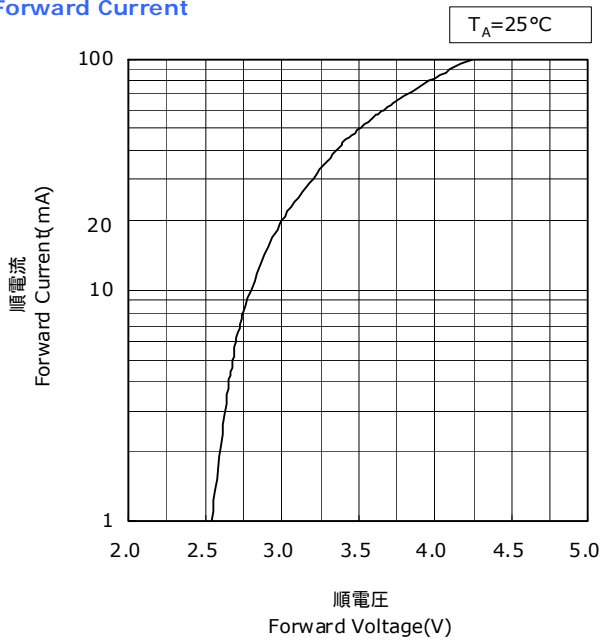

周囲温度-順電圧特性
Ambient Temperature vs
Forward Voltage

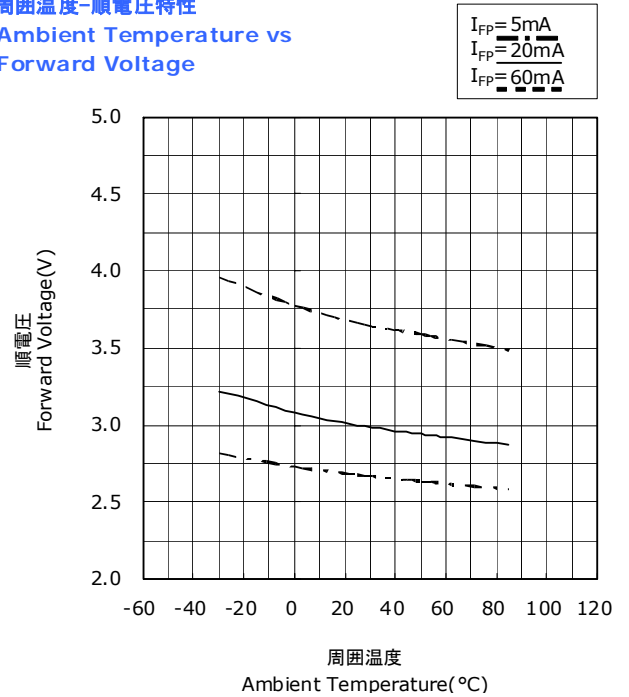

順電流-相対光束特性
Forward Current vs
Relative Luminous Flux

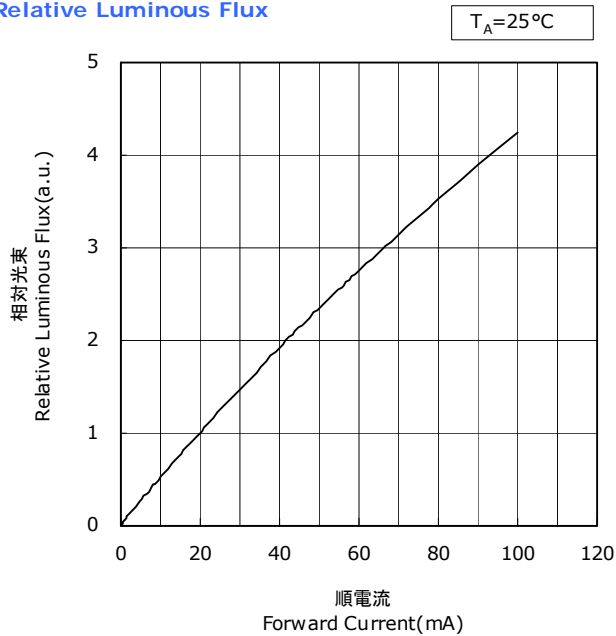

周囲温度-相対光束特性
Ambient Temperature vs
Relative Luminous Flux

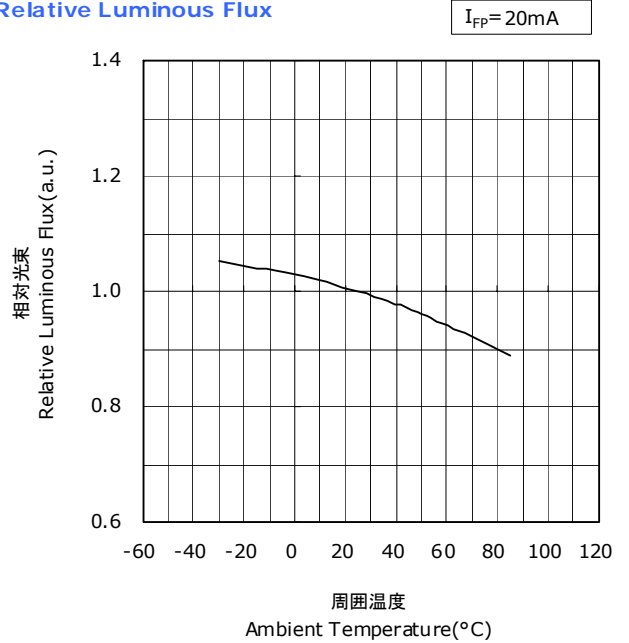

FORWARD CURRENT CHARACTERISTICS / TEMPERATURE CHARACTERISTICS

* 本特性は参考です。
All characteristics shown are for reference only and are not guaranteed.

NxSW206x
管理番号 No. STS-DA7-1266A

順電流-色度特性
Forward Current vs
Chromaticity Coordinate

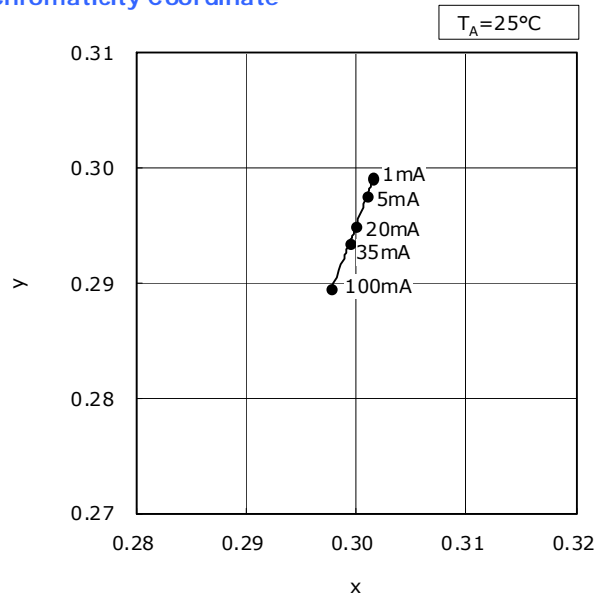

周囲温度-色度特性
Ambient Temperature vs
Chromaticity Coordinate

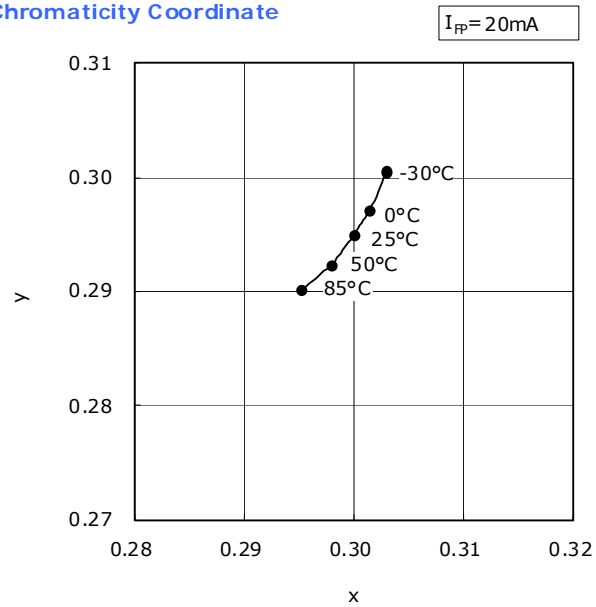

RELIABILITY

(1) Tests and Results

Test	Reference Standard	Test Conditions	Test Duration	Failure Criteria #	Units Failed/Tested
Resistance to Soldering Heat (Reflow Soldering)	JEITA ED-4701 300 301	$T_{sld}=260^{\circ}\text{C}$, 10sec, 2reflows, Precondition: 30°C , 70%RH, 168hr		#1	0/50
Solderability (Reflow Soldering)	JEITA ED-4701 303 303A	$T_{sld}=245\pm 5^{\circ}\text{C}$, 5sec, Lead-free Solder(Sn-3.0Ag-0.5Cu)		#2	0/50
Thermal Shock	JEITA ED-4701 300 307	0°C to 100°C , 15sec dwell	20cycles	#1	0/50
Temperature Cycle	JEITA ED-4701 100 105	$-40^{\circ}\text{C}(30\text{min})\sim 25^{\circ}\text{C}(5\text{min})\sim 100^{\circ}\text{C}(30\text{min})\sim 25^{\circ}\text{C}(5\text{min})$	100cycles	#1	0/50
Moisture Resistance (Cyclic)	JEITA ED-4701 200 203	$25^{\circ}\text{C}\sim 65^{\circ}\text{C}\sim -10^{\circ}\text{C}$, 90%RH, 24hr per cycle	10cycles	#1	0/50
High Temperature Storage	JEITA ED-4701 200 201	$T_A=100^{\circ}\text{C}$	1000hours	#1	0/50
Temperature Humidity Storage	JEITA ED-4701 100 103	$T_A=60^{\circ}\text{C}$, RH=90%	1000hours	#1	0/50
Low Temperature Storage	JEITA ED-4701 200 202	$T_A=-40^{\circ}\text{C}$	1000hours	#1	0/50
Room Temperature Operating Life Condition 1		$T_A=25^{\circ}\text{C}$, $I_F=20\text{mA}$	1000hours	#1	0/50
Room Temperature Operating Life Condition 2		$T_A=25^{\circ}\text{C}$, $I_F=35\text{mA}$	500hours	#1	0/50
High Temperature Operating Life		$T_A=85^{\circ}\text{C}$, $I_F=8.5\text{mA}$	1000hours	#1	0/50
Temperature Humidity Operating Life		60°C , RH=90%, $I_F=15\text{mA}$	500hours	#1	0/50
Low Temperature Operating Life		$T_A=-30^{\circ}\text{C}$, $I_F=20\text{mA}$	1000hours	#1	0/50
Vibration	JEITA ED-4701 400 403	200m/s^2 , 100~2000~100Hz, 4cycles, 4min, each X, Y, Z	48minutes	#1	0/50
Board Bending	JEITA ED-4702B 003	1bend to a deflection of 3mm for $5\pm 1\text{sec}$		#1	0/50
Soldering Joint Shear Strength	JEITA ED-4702B 002 3	5N, $10\pm 1\text{sec}$		#1	0/50

NOTES:

Measurements are performed after allowing the LEDs to return to room temperature.

(2) Failure Criteria

Criteria #	Items	Conditions	Failure Criteria
#1	Forward Voltage(V_F)	$I_F=20\text{mA}$	$> \text{U.S.L.} \times 1.1$
	Luminous Flux(Φ_V)	$I_F=20\text{mA}$	$< \text{L.S.L.} \times 0.7$
	Reverse Current(I_R)	$V_R=5\text{V}$	$> \text{U.S.L.} \times 2.0$
#2	Solderability	-	Less than 95% solder coverage

U.S.L. : Upper Specification Limit L.S.L. : Lower Specification Limit

CAUTIONS

(1) Storage

Conditions		Temperature	Humidity	Time
Storage	Before Opening Aluminum Bag	≤30°C	≤90%RH	Within 1 Year from Delivery Date
	After Opening Aluminum Bag	≤30°C	≤70%RH	≤168hours
Baking		65±5°C	-	≥24hours

- Product complies with JEDEC MSL 3 or equivalent. See IPC/JEDEC STD-020 for moisture-sensitivity details.
- Absorbed moisture in LED packages can vaporize and expand during soldering, which can cause interface delamination and result in optical performance degradation. Products are packed in moisture-proof aluminum bags to minimize moisture absorption during transportation and storage.
Included silica gel desiccants change from blue to red if moisture had penetrated bags.
- After opening the moisture-proof aluminum bag, the products should go through the soldering process within the range of the conditions stated above. Unused remaining LEDs should be stored with silica gel desiccants in a hermetically sealed container, preferably the original moisture-proof bags for storage.
- After the "Period After Opening" storage time has been exceeded or silica gel desiccants are no longer blue, the products should be baked. Baking should only be done once.
- Customer is advised to keep the LEDs in an airtight container when not in use. Exposure to a corrosive environment may cause the plated metal parts of the product to tarnish, which could adversely affect soldering and optical characteristics. It is also recommended to return the LEDs to the original moisture proof bags and reseal.
- After assembly and during use, silver plating can be affected by the corrosive gases emitted by components and materials in close proximity of the LEDs within an end product, and the gases entering into the product from the external atmosphere. The above should be taken into consideration when designing.
Resin materials, in particular, may contain substances which can affect silver plating, such as halogen.
- Do not use sulfur-containing materials in commercial products. Some materials, such as seals and adhesives, may contain sulfur. The extremely corroded or contaminated plating of LEDs might cause an open circuit. Silicone rubber is recommended as a material for seals. Bear in mind, the use of silicones may lead to silicone contamination of electrical contacts inside the products, caused by low molecular weight volatile siloxane.
- To prevent water condensation, please avoid large temperature and humidity fluctuations for the storage conditions.

(2) Directions for Use

- When designing a circuit, the current through each LED must not exceed the Absolute Maximum Rating. Operating at a constant current per LED is recommended. In case of operating at a constant voltage, Circuit B is recommended. If the LEDs are operated with constant voltage using Circuit A, the current through the LEDs may vary due to the variation in Forward Voltage characteristics of the LEDs.

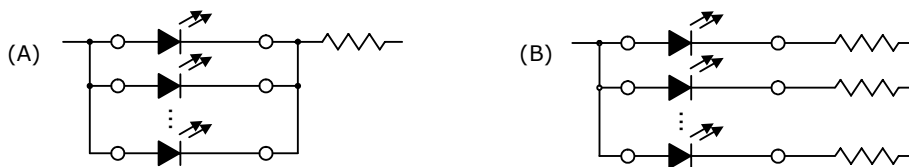

- LEDs should be operated in forward bias. Driving circuits must not subject LEDs to either forward or reverse voltage while off. Continuous reverse voltage can cause migration and LED damage.
- For stabilizing the LED characteristics, it is recommended to operate at greater than 10% nominal current.
- Care must be taken to ensure that the reverse voltage will not exceed the Absolute Maximum Rating when using the LEDs with matrix drive.
- For outdoor use, necessary measures should be taken to prevent water, moisture and salt air damage.

(3) Handling Precautions

- Do not handle LEDs with bare hands, it may contaminate the LED surface and affect optical characteristics.
In the worst case, catastrophic failure from excess pressure through wire-bond breaks and package damage may result.
- When handling the product with tweezers, be careful not to apply excessive force to the resin.
Otherwise, The resin can be cut, chipped, delaminate or deformed, causing wire-bond breaks and catastrophic failures.
- Dropping the product may cause damage.
- Do not stack assembled PCBs together. Failure to comply can cause the resin portion of the product to be cut, chipped, delaminated and/or deformed. It may cause wire to break, leading to catastrophic failures.

(4) Design Consideration

- PCB warpage after mounting the products onto a PCB can cause the package to break.
The LED should be placed in a way to minimize the stress on the LEDs due to PCB bow and twist.
- The position and orientation of the LEDs affect how much mechanical stress is exerted on the LEDs placed near the score lines.
The LED should be placed in a way to minimize the stress on the LEDs due to board flexing.
- Board separation must be performed using special jigs, not using hands.

(5) Electrostatic Discharge (ESD)

- The products are sensitive to static electricity or surge voltage. ESD can damage a die and its reliability.
When handling the products, the following measures against electrostatic discharge are strongly recommended:
 - Eliminating the charge
 - Grounded wriststrap, ESD footwear, clothes, and floors
 - Grounded workstation equipment and tools
 - ESD table/shelf mat made of conductive materials
- Proper grounding is required for all devices, equipment, and machinery used in product assembly.
Surge protection should be considered when designing of commercial products.
- If tools or equipment contain insulating materials such as glass or plastic,
the following measures against electrostatic discharge are strongly recommended:
 - Dissipating static charge with conductive materials
 - Preventing charge generation with moisture
 - Neutralizing the charge with ionizers
- The customer is advised to check if the LEDs are damaged by ESD
when performing the characteristics inspection of the LEDs in the application.
Damage can be detected with a forward voltage measurement or a light-up test at low current ($\leq 1\text{mA}$).
- ESD damaged LEDs may have an increased leakage current, current flow at a low voltage or no longer illuminate at a low current.
Failure Criteria: $V_F < 2.0\text{V}$ at $I_F = 0.5\text{mA}$

(6) Thermal Management

- Proper thermal management is an important when designing products with LEDs. LED die temperature is affected by PCB thermal resistance and LED spacing on the board. Please design products in a way that the LED die temperature does not exceed the maximum Junction Temperature (T_J).
- Drive current should be determined for the surrounding ambient temperature (T_A) to dissipate the heat from the product.

(7) Cleaning

- If required, isopropyl alcohol (IPA) should be used. Other solvents may cause premature failure to the LEDs due to the damage to the resin portion. The effects of such solvents should be verified prior to use.
In addition, the use of CFCs such as Freon is heavily regulated.
- Ultrasonic cleaning is not recommended since it may have adverse effects on the LEDs depending on the ultrasonic power and how LED is assembled.
If ultrasonic cleaning must be used, the customer is advised to make sure the LEDs will not be damaged prior to cleaning.

(8) Eye Safety

- In 2006, the International Electrical Commission (IEC) published IEC 62471:2006 Photobiological safety of lamps and lamp systems, which added LEDs in its scope.
On the other hand, the IEC 60825-1:2007 laser safety standard removed LEDs from its scope.
However, please be advised that some countries and regions have adopted standards based on the IEC laser safety standard IEC 60825-1:2011/2001, which still includes LEDs in its scope.
Most of Nichia's LEDs can be classified as belonging into either the Exempt Group or Risk Group 1.
High-power LEDs, that emit light containing blue wavelengths, may be classified as Risk Group 2.
Please proceed with caution when viewing directly any LEDs driven at high current, or viewing LEDs with optical instruments which may greatly increase the damages to your eyes.
- Viewing a flashing light may cause eye discomfort. When incorporating the LED into your product, please be careful to avoid adverse effects on the human body caused by light stimulation.

(9) Others

- The LEDs described in this brochure are intended to be used for ordinary electronic equipment (such as office equipment, communications equipment, measurement instruments and household appliances).
Consult Nichia's sales staff in advance for information on the applications in which exceptional quality and reliability are required, particularly when the failure or malfunction of the LEDs may directly jeopardize life or health (such as for airplanes, aerospace, submersible repeaters, nuclear reactor control system, automobiles, traffic control equipment, life support systems and safety devices).
- The customer shall not reverse engineer by disassembling or analysis of the LEDs without having prior written consent from Nichia. When defective LEDs are found, the customer shall inform Nichia directly before disassembling or analysis.
- Both the customers and Nichia will agree on official specifications of supplied products before a customer's volume production.
- Specifications and appearance subject to change for improvement without notice.