

Features

- High operating temperature
- High output voltage
- Robust cylindrical housing
- Biasing magnet build in
- Signal amplitude independent of speed
- Easily connectable

Typical applications

- Detection of speed
- Detection of position
- Detection of sense of rotation
- Angle encoder
- Linear position sensing

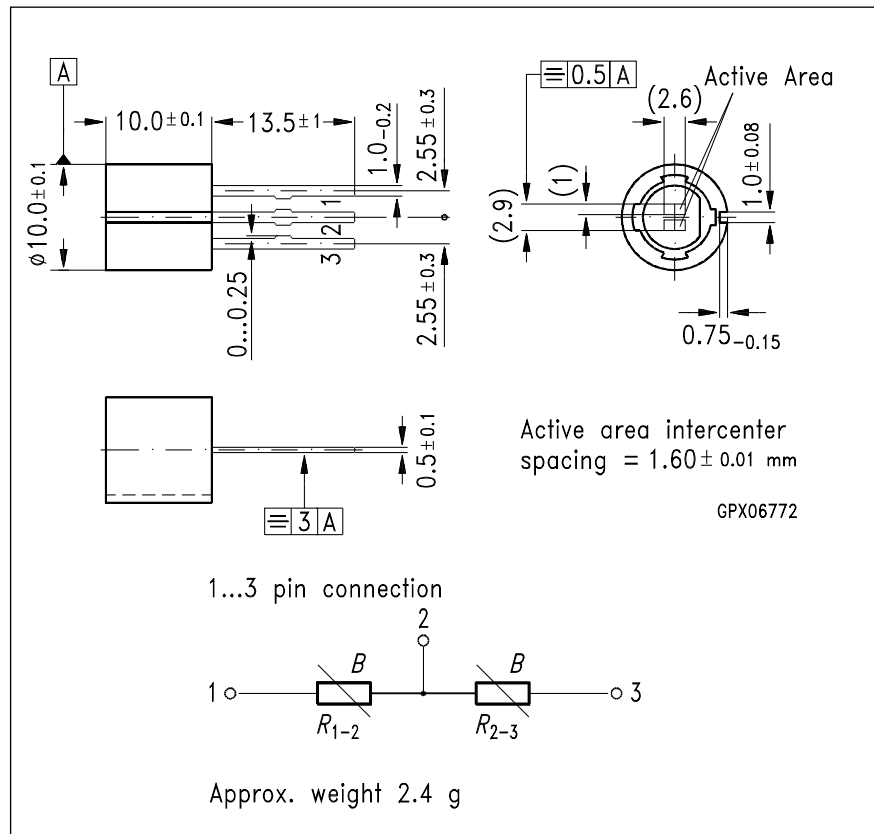

Type	Ordering Code
FP 210 D 250-22	Q65210-D250-W5

The differential magnetoresistive sensor FP 201 D 250-22 consists of two series coupled D-type InSb/NiSb semiconductor resistors. The resistance value of the MRs, which are mounted onto an insulated ferrite substrate, can be magnetically controlled. The sensor is encapsulated in a plastic package with three in-line contacts extending from the base. The basic resistance of the total system in the unbiased state is $2 \times 250 \Omega$. A permanent magnet which supplies a biasing magnetic field is built into the housing.

Maximum ratings

Parameter	Symbol	Value	Unit
Operating temperature	T_A	- 40 / + 140	°C
Storage temperature	T_{stg}	- 40 / + 150	°C
Power dissipation ¹⁾	P_{tot}	400	mW
Supply voltage ²⁾	V_{IN}	7.5	V
Insulation voltage between terminals and casing	V_I	> 100	V
Thermal conductivity	G_{thA}	≥ 5	mW/K

Characteristics ($T_A = 25\text{ °C}$)

Nominal supply voltage	$V_{IN N}$	5	V
Total resistance, ($\delta = \infty$, $I \leq 1\text{ mA}$)	R_{1-3}	1000...1600	Ω
Center symmetry ³⁾ ($\delta = \infty$)	M	≤ 10	%
Offset voltage ⁴⁾ (at $V_{IN N}$ and $\delta = \infty$)	V_0	≤ 130	mV
Open circuit output voltage ⁵⁾ (at $V_{IN N}$ and $\delta = 0.2\text{ mm}$)	$V_{out pp}$	> 1100	mV
Cut-off frequency	f_c	> 20	kHz

Measuring arrangements

By approaching a soft iron part close to the sensor a change in its resistance is obtained. The potential divider circuit of the magneto resistor causes a reduction in the temperature dependence of the output voltage V_{OUT} .

1) Corresponding to diagram $P_{tot} = f(T_A)$

2) Corresponding to diagram $V_{IN} = f(T_A)$

3)
$$M = \frac{R_{1-2} - R_{2-3}}{R_{1-2}} \times 100\% \text{ for } R_{1-2} > R_{2-3}$$

4) Corresponding to measuring circuit in **Fig. 2**

5) Corresponding to measuring circuit in **Fig. 2** and arrangement as shown in **Fig. 1**

1. Digital revolution counting

For digital revolution counting, the sensor should be actuated by a magnetically soft iron toothed wheel. The tooth spacing should correspond to about twice the magneto resistor intercenter spacing (see Fig. 1).

The two resistors of the sensor are supplemented by two additional resistors in order to obtain the sensor output voltage as a bridge voltage V_{OUT} . The output voltage V_{OUT} without excitation then is 0 V when the offset is compensated.

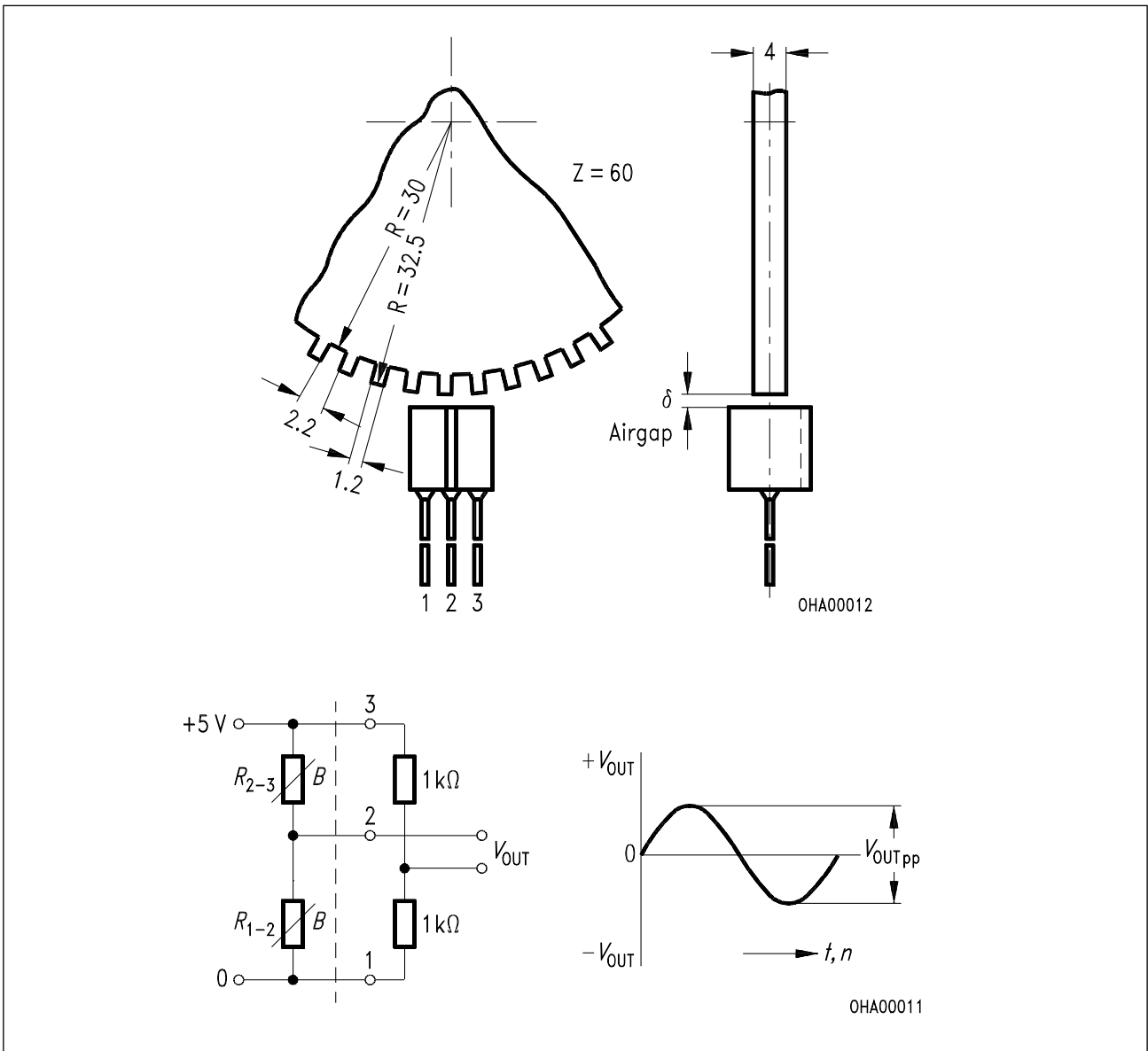

Fig. 1
Schematic representation of a toothed wheel actuating an FP 210 D 250-22

Fig. 2
Measuring circuit and output voltage V_{OUT} waveform

2. Linear distance measurement

To convert small distances into a proportional electric signal, a small soft iron part of definite width (e.g. $b = 1.8 \text{ mm}$) is moved over the face of the sensor.

Proportional signals for distances up to 1.5 mm can be obtained in this way. The sinusoidal output signal gives a voltage proportional to distance in the zero crossover region (see **Fig. 3**).

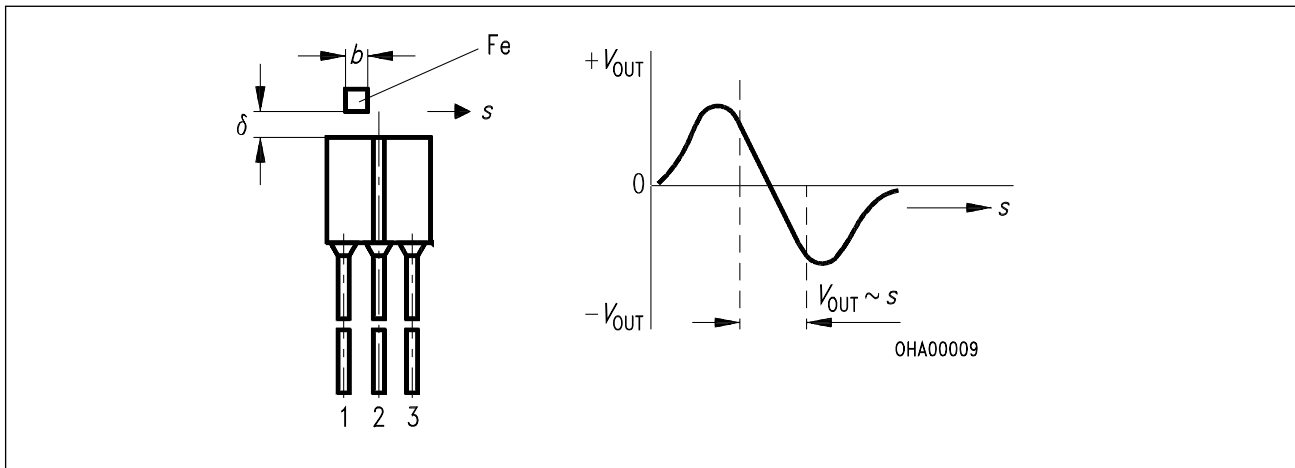
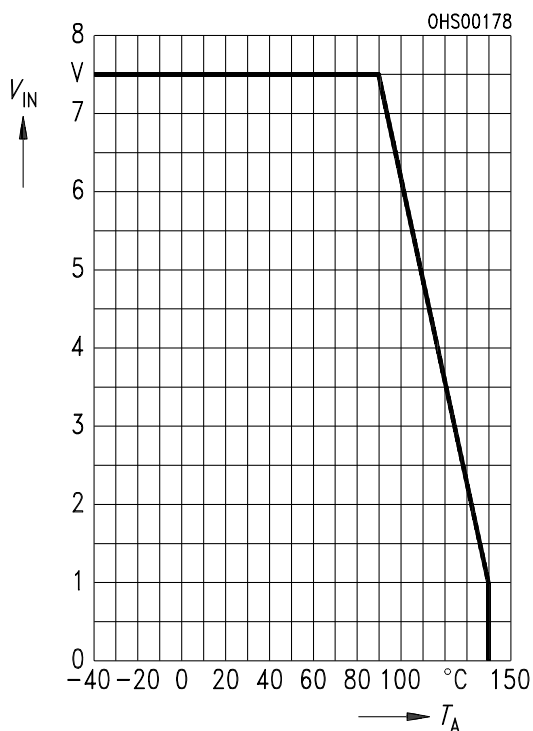

Fig. 3
Arrangement for analogue application

Maximum supply voltage versus temperature

$V_{IN} = f(T_A), \delta = \infty$



Output voltage (typical) versus temperature $V_{OUTpp} = f(T_A)$, $\delta = 0.2 \text{ mm}$
 V_{OUTpp} at $T_A = 25 \text{ }^\circ\text{C} \hat{=} 100\%$

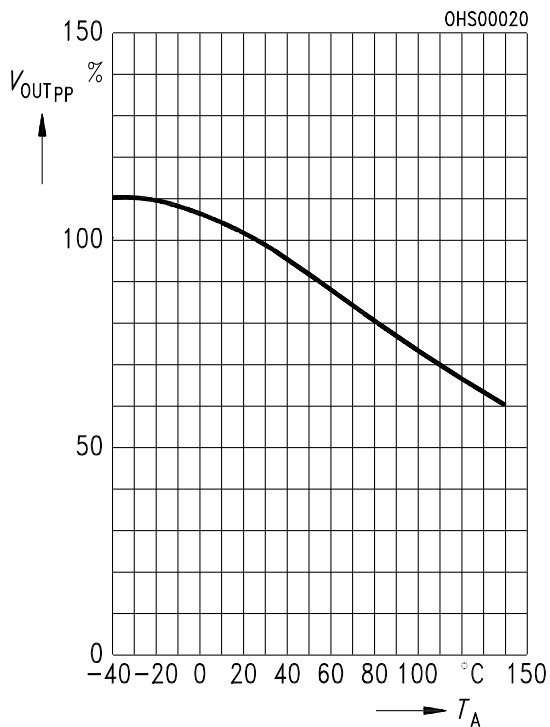

Output voltage (typical) versus airgap $V_{OUTpp} = f(\delta)$, $T_A = 25 \text{ }^\circ\text{C}$
 V_{OUTpp} at $\delta = 0.2 \text{ mm} \hat{=} 100\%$

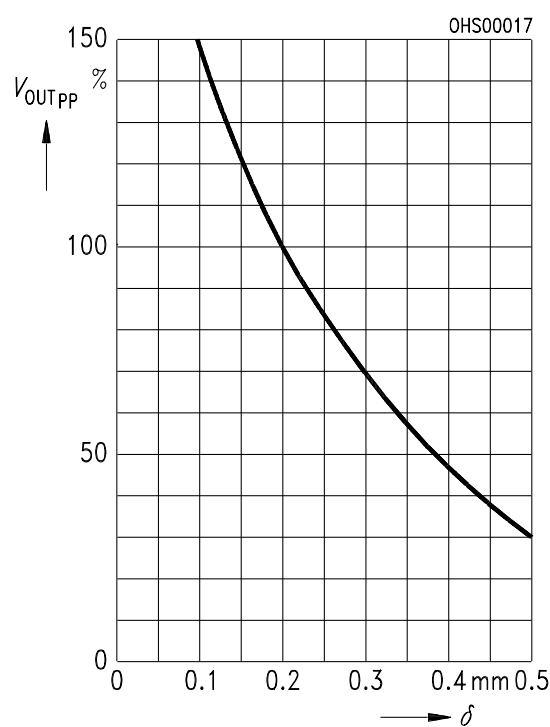

Total resistance (typical) versus temperature
 $R_{1-3} = f(T_A)$, $\delta = \infty$

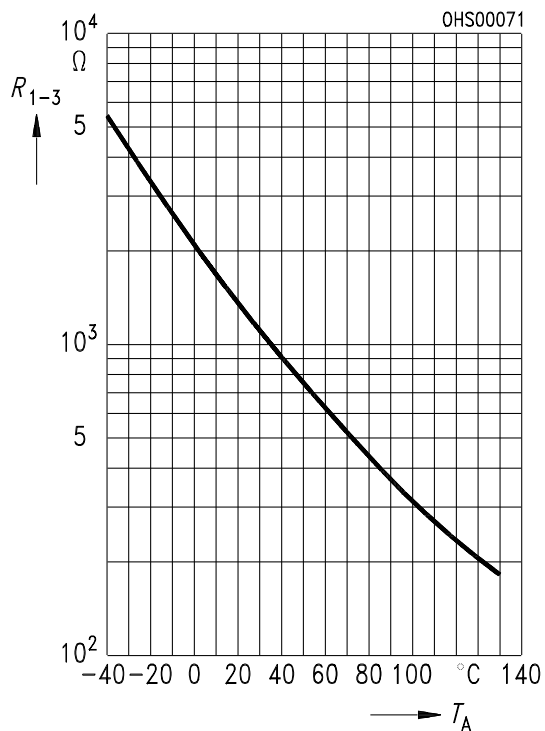

Max. power dissipation versus temperature
 $P_{tot} = f(T_A)$, $\delta = \infty$

