

## Ultrabright White LED, $\varnothing$ 5 mm Untinted Non-Diffused

### Description

The TLCW5100 series is a clear, non diffused 5 mm LED for high end applications where supreme luminous intensity required.

These lamps with clear untinted plastic case utilize the highly developed ultrabright InGaN technologies.

The lens and the viewing angle is optimized to achieve best performance of light output and visibility.



19223



### Features

- Untinted non diffused lens
- Utilizing ultrabright InGaN technology
- High luminous intensity
- Luminous intensity and color categorized for each packing unit
- ESD-withstand voltage:  
1 kV for InGaN
- Lead-free device

### Applications

- Interior and exterior lighting
- Outdoor LED panels
- Instrumentation and front panel indicators
- Replaces incandescent lamps
- Light guide design

### Parts Table

Part	Color, Luminous Intensity	Angle of Half Intensity ( $\pm\phi$ )	Technology
TLCW5100	White, $I_V = 4000$ mcd (typ.)	9 °	InGaN / TAG on SiC

### Absolute Maximum Ratings

$T_{amb} = 25$  °C, unless otherwise specified

#### TLCW5100

Parameter	Test condition	Symbol	Value	Unit
Reverse voltage		$V_R$	5	V
DC forward current	$T_{amb} \leq 60$ °C	$I_F$	30	mA
Surge forward current	$t_p \leq 10$ $\mu$ s	$I_{FSM}$	0.1	A
Power dissipation	$T_{amb} \leq 60$ °C	$P_V$	135	mW
Junction temperature		$T_j$	100	°C
Operating temperature range		$T_{amb}$	- 40 to + 100	°C
Storage temperature range		$T_{stg}$	- 40 to + 100	°C
Soldering temperature	$t \leq 5$ s	$T_{sd}$	260	°C
Thermal resistance junction/ ambient		$R_{thJA}$	300	K/W

### Optical and Electrical Characteristics

$T_{amb} = 25\text{ }^{\circ}\text{C}$ , unless otherwise specified

#### White

##### TLCW5100

Parameter	Test condition	Symbol	Min	Typ.	Max	Unit
Luminous intensity	$I_F = 30\text{ mA}$	$I_V$	1000	4000		mcd
Chromaticity coordinate x acc. to CIE 1931	$I_F = 30\text{ mA}$	x		0.33		
Chromaticity coordinate y acc. to CIE 1931	$I_F = 30\text{ mA}$	y		0.33		
Angle of half intensity	$I_F = 30\text{ mA}$	$\phi$		$\pm 9$		deg
Forward voltage	$I_F = 30\text{ mA}$	$V_F$		3.9	4.5	V
Reverse voltage	$I_R = 10\text{ }\mu\text{A}$	$V_R$	5			V
Temperature coefficient of $V_F$	$I_F = 30\text{ mA}$	$TC_{V_F}$		- 4		mV/K
Temperature coefficient of $I_V$	$I_F = 30\text{ mA}$	$TC_{I_V}$		- 0.5		% / K

### Chromaticity Coordinate Classification

Group	X		Y	
	min	max	min	max
3a	0.2900	0.3025	$Y = 1.4x - 0.121$	$Y = 1.4x - 0.071$
3b	0.3025	0.3150	$Y = 1.4x - 0.121$	$Y = 1.4x - 0.071$
3c	0.2900	0.3025	$Y = 1.4x - 0.171$	$Y = 1.4x - 0.121$
3d	0.3025	0.3150	$Y = 1.4x - 0.171$	$Y = 1.4x - 0.121$
4a	0.3150	0.3275	$Y = 1.4x - 0.121$	$Y = 1.4x - 0.071$
4b	0.3275	0.3400	$Y = 1.4x - 0.121$	$Y = 1.4x - 0.071$
4c	0.3150	0.3275	$Y = 1.4x - 0.171$	$Y = 1.4x - 0.121$
4d	0.3275	0.3400	$Y = 1.4x - 0.171$	$Y = 1.4x - 0.121$
5a	0.3400	0.3525	$Y = 1.4x - 0.121$	$Y = 1.4x - 0.071$
5b	0.3525	0.3650	$Y = 1.4x - 0.121$	$Y = 1.4x - 0.071$
5c	0.3400	0.3525	$Y = 1.4x - 0.171$	$Y = 1.4x - 0.121$
5d	0.3525	0.3650	$Y = 1.4x - 0.171$	$Y = 1.4x - 0.121$

tolerance  $\pm 0.005$

**Typical Characteristics** ( $T_{amb} = 25\text{ }^{\circ}\text{C}$  unless otherwise specified)

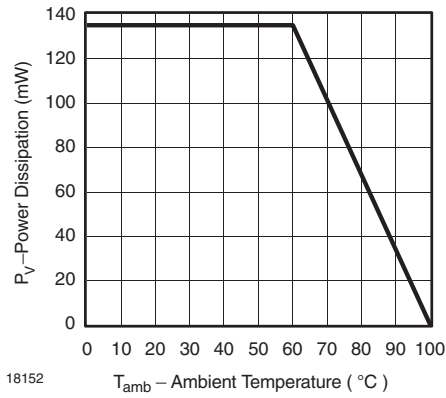

Figure 1. Power Dissipation vs. Ambient Temperature

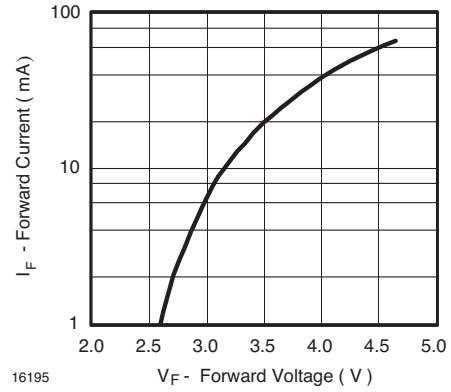

Figure 4. Forward Current vs. Forward Voltage

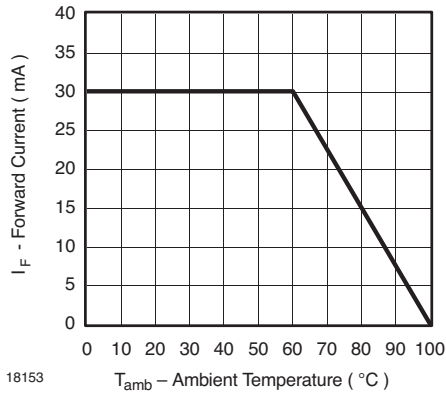

Figure 2. Forward Current vs. Ambient Temperature

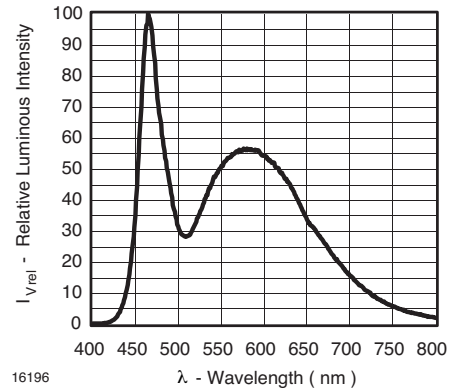

Figure 5. Relative Intensity vs. Wavelength

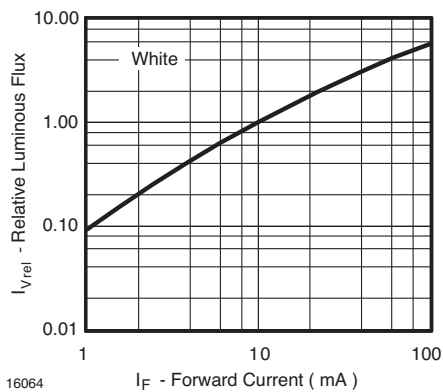

Figure 3. Relative Luminous Flux vs. Forward Current

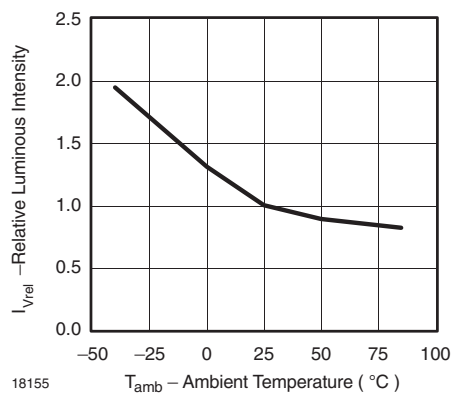

Figure 6. Relative Luminous Intensity vs. Amb. Temperature

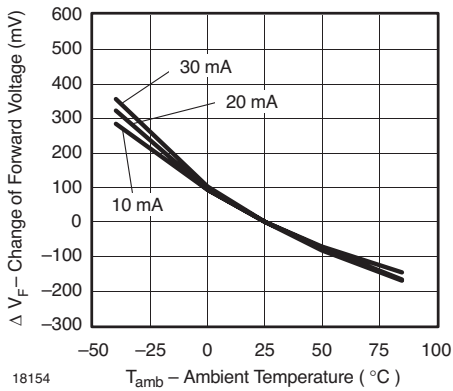

Figure 7. Change of Forward Voltage vs. Ambient Temperature

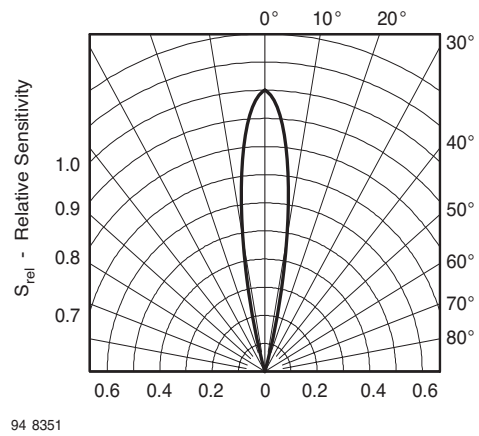

Figure 10. Relative Radiant Sensitivity vs. Angular Displacement

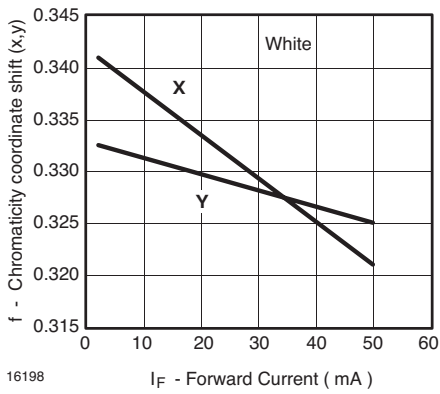

Figure 8. Chromaticity Coordinate Shift vs. Forward Current

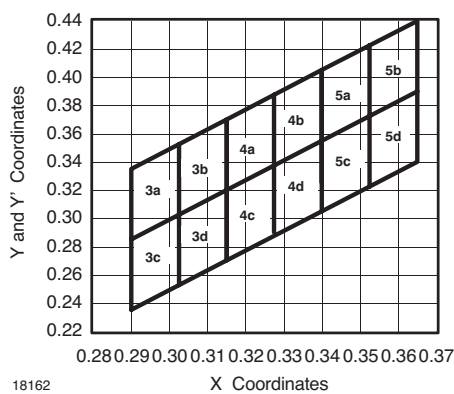
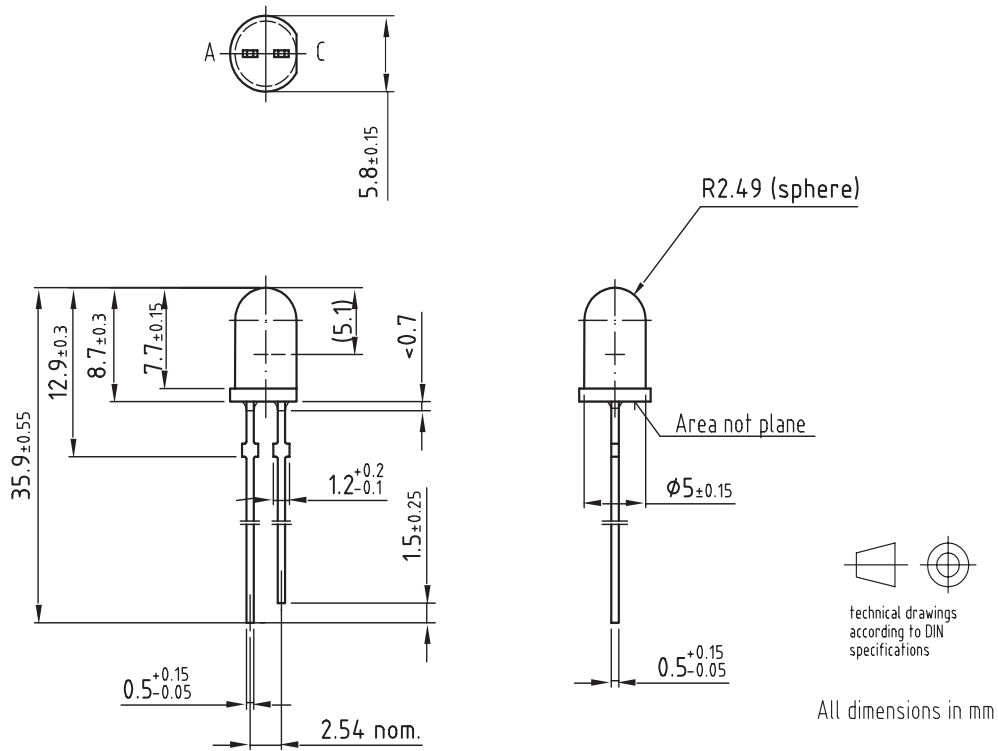

Figure 9. Coordinates of Colorgroups

## Package Dimensions in mm



Drawing-No.: 6.544-5258.04-4  
 Issue: 6; 04.07.03

9612121

### Ozone Depleting Substances Policy Statement

It is the policy of **Vishay Semiconductor GmbH** to

1. Meet all present and future national and international statutory requirements.
2. Regularly and continuously improve the performance of our products, processes, distribution and operating systems with respect to their impact on the health and safety of our employees and the public, as well as their impact on the environment.

It is particular concern to control or eliminate releases of those substances into the atmosphere which are known as ozone depleting substances (ODSs).

The Montreal Protocol (1987) and its London Amendments (1990) intend to severely restrict the use of ODSs and forbid their use within the next ten years. Various national and international initiatives are pressing for an earlier ban on these substances.

**Vishay Semiconductor GmbH** has been able to use its policy of continuous improvements to eliminate the use of ODSs listed in the following documents.

1. Annex A, B and list of transitional substances of the Montreal Protocol and the London Amendments respectively
2. Class I and II ozone depleting substances in the Clean Air Act Amendments of 1990 by the Environmental Protection Agency (EPA) in the USA
3. Council Decision 88/540/EEC and 91/690/EEC Annex A, B and C (transitional substances) respectively.

**Vishay Semiconductor GmbH** can certify that our semiconductors are not manufactured with ozone depleting substances and do not contain such substances.

**We reserve the right to make changes to improve technical design  
and may do so without further notice.**

Parameters can vary in different applications. All operating parameters must be validated for each customer application by the customer. Should the buyer use Vishay Semiconductors products for any unintended or unauthorized application, the buyer shall indemnify Vishay Semiconductors against all claims, costs, damages, and expenses, arising out of, directly or indirectly, any claim of personal damage, injury or death associated with such unintended or unauthorized use.

Vishay Semiconductor GmbH, P.O.B. 3535, D-74025 Heilbronn, Germany  
Telephone: 49 (0)7131 67 2831, Fax number: 49 (0)7131 67 2423



### Notice

Specifications of the products displayed herein are subject to change without notice. Vishay Intertechnology, Inc., or anyone on its behalf, assumes no responsibility or liability for any errors or inaccuracies.

Information contained herein is intended to provide a product description only. No license, express or implied, by estoppel or otherwise, to any intellectual property rights is granted by this document. Except as provided in Vishay's terms and conditions of sale for such products, Vishay assumes no liability whatsoever, and disclaims any express or implied warranty, relating to sale and/or use of Vishay products including liability or warranties relating to fitness for a particular purpose, merchantability, or infringement of any patent, copyright, or other intellectual property right.

The products shown herein are not designed for use in medical, life-saving, or life-sustaining applications. Customers using or selling these products for use in such applications do so at their own risk and agree to fully indemnify Vishay for any damages resulting from such improper use or sale.