



TSM2302

20V N-Channel Enhancement Mode MOSFET

SOT-23



Pin assignment:

1. Gate
2. Source
3. Drain

V_{DS} = 20V

R_{DS (on)}, V_{GS} @ 4.5V, I_{DS} @ 3.6A = 65mΩ

R_{DS (on)}, V_{GS} @ 2.5V, I_{DS} @ 3.1A = 95mΩ

Features

- ◇ Advanced trench process technology
- ◇ High density cell design for ultra low on-resistance
- ◇ Excellent thermal and electrical capabilities
- ◇ Compact and low profile SOT-23 package

Block Diagram

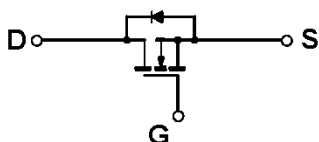

Ordering Information

Part No.	Packing	Package
TSM2302CX	Tape & Reel	SOT-23

Absolute Maximum Rating (Ta = 25°C unless otherwise noted)

Parameter	Symbol	Limit	Unit	
Drain-Source Voltage	V _{DS}	20V	V	
Gate-Source Voltage	V _{GS}	± 8	V	
Continuous Drain Current	I _D	2.4	A	
Pulsed Drain Current	I _{DM}	10	A	
Maximum Power Dissipation		Ta = 25°C	1.25	W
		Ta = 75°C	0.8	
Operating Junction Temperature	T _J	+150	°C	
Operating Junction and Storage Temperature Range	T _J , T _{STG}	- 55 to +150	°C	

Thermal Performance

Parameter	Symbol	Limit	Unit
Lead Temperature (1/8" from case)	T _L	5	S
Junction to Ambient Thermal Resistance (PCB mounted)	Rθja	100	°C/W

Note: Surface mounted on FR4 board t<=5sec.



Electrical Characteristics

Rate $I_D = 2.4A$, ($T_a = 25^\circ C$ unless otherwise noted)

Parameter	Conditions	Symbol	Min	Typ	Max	Unit
Static						
Drain-Source Breakdown Voltage	$V_{GS} = 0V, I_D = 250\mu A$	BV_{DSS}	20	--	--	V
Drain-Source On-State Resistance	$V_{GS} = 4.5V, I_D = 3.6A$	$R_{DS(ON)}$	--	50	65	m Ω
Drain-Source On-State Resistance	$V_{GS} = 2.5V, I_D = 3.1A$	$R_{DS(ON)}$	--	75	95	
Gate Threshold Voltage	$V_{DS} = V_{GS}, I_D = 250\mu A$	$V_{GS(TH)}$	0.45	--	--	V
Zero Gate Voltage Drain Current	$V_{DS} = 20V, V_{GS} = 0V$	I_{DSS}	--	--	1.0	μA
Gate Body Leakage	$V_{GS} = \pm 8V, V_{DS} = 0V$	I_{GSS}	--	--	± 100	nA
On-State Drain Current	$V_{DS} \geq 5V, V_{GS} = 4.5V$	$I_{D(ON)}$	6	--	--	A
Forward Transconductance	$V_{DS} = 5V, I_D = 3.6A$	g_{fs}	--	10	--	S
Dynamic						
Total Gate Charge	$V_{DS} = 10V, I_D = 3.6A,$ $V_{GS} = 4.5V$	Q_g	--	5.2	10	nC
Gate-Source Charge		Q_{gs}	--	0.65	--	
Gate-Drain Charge		Q_{gd}	--	1.5	--	
Turn-On Delay Time	$V_{DD} = 10V, R_L = 10\Omega,$ $I_D = 1A, V_{GEN} = 4.5V,$ $R_G = 6\Omega$	$t_{d(on)}$	--	7	15	nS
Turn-On Rise Time		t_r	--	55	80	
Turn-Off Delay Time		$t_{d(off)}$	--	16	60	
Turn-Off Fall Time		t_f	--	10	25	
Input Capacitance	$V_{DS} = 10V, V_{GS} = 0V,$ $f = 1.0MHz$	C_{iss}	--	450	--	pF
Output Capacitance		C_{oss}	--	70	--	
Reverse Transfer Capacitance		C_{rss}	--	43	--	
Source-Drain Diode						
Max. Diode Forward Current		I_S	--	--	1.6	A
Diode Forward Voltage	$I_S = 1.0A, V_{GS} = 0V$	V_{SD}	--	0.75	1.2	V

Note : pulse test: pulse width $\leq 300\mu S$, duty cycle $\leq 2\%$

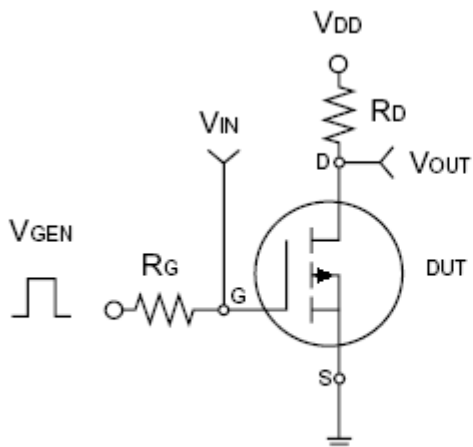

Switching Test Circuit

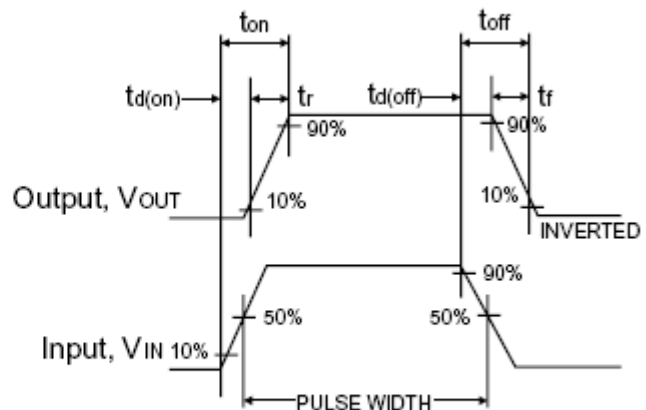

Switchin Waveforms

Typical Characteristics Curve ($T_a = 25^\circ\text{C}$ unless otherwise noted)

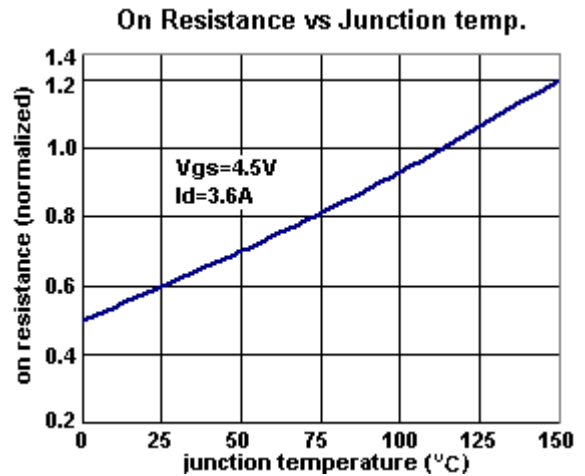
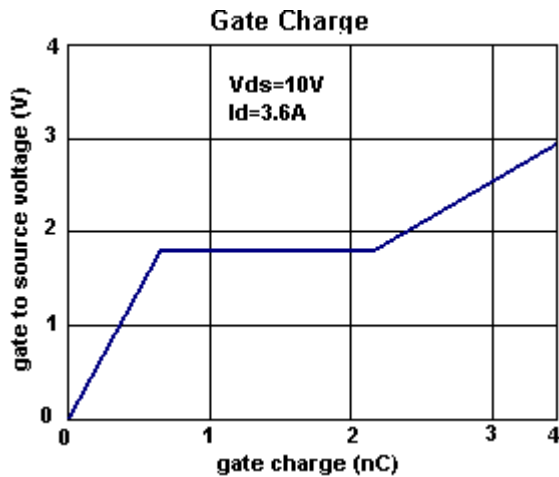
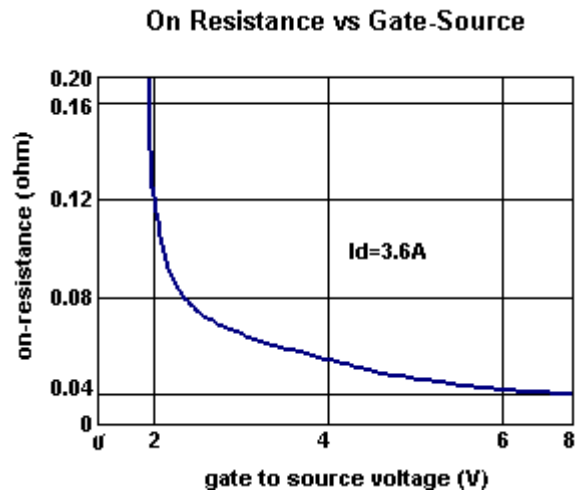
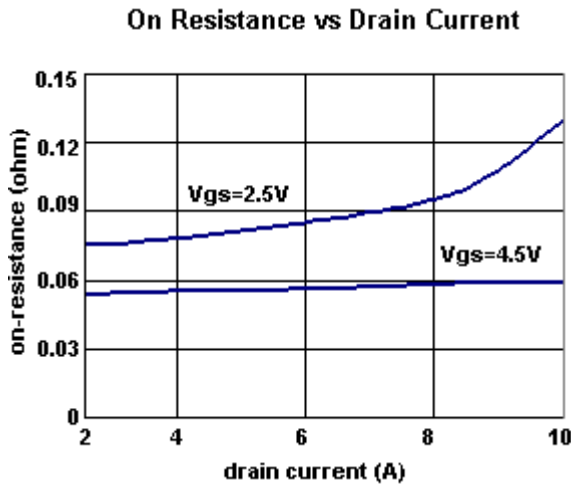
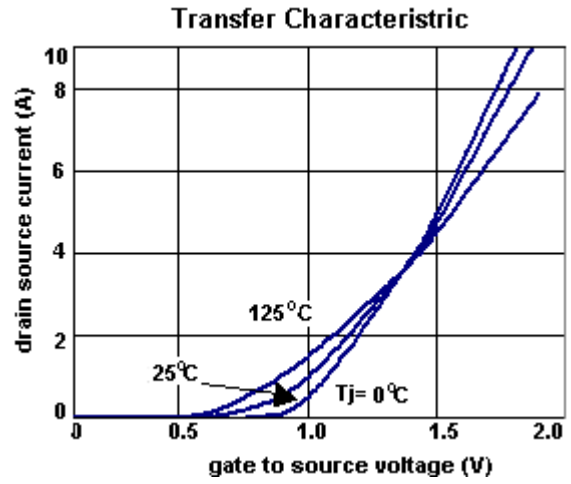
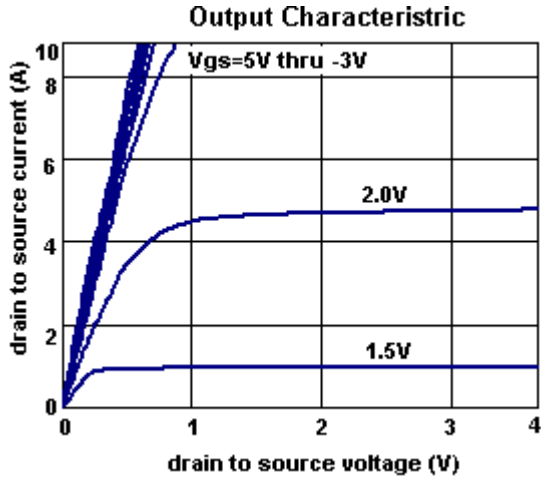



Typical Characteristics Curve (Ta = 25 °C unless otherwise noted)

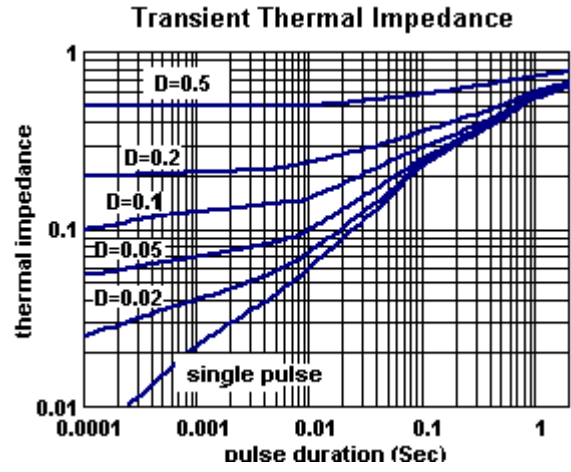
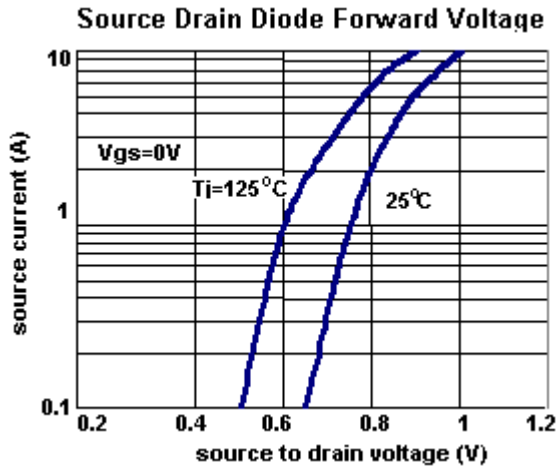

SOT-23 Mechanical Drawing

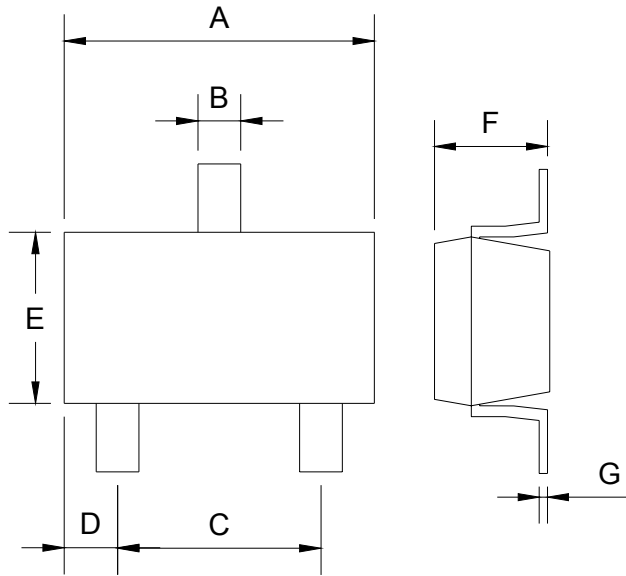

SOT-23 DIMENSION				
DIM	MILLIMETERS		INCHES	
	MIN	MAX	MIN	MAX
A	2.88	2.91	0.113	0.115
B	0.39	0.42	0.015	0.017
C	1.78	2.03	0.070	0.080
D	0.51	0.61	0.020	0.024
E	1.59	1.66	0.063	0.065
F	1.04	1.08	0.041	0.043
G	0.07	0.09	0.003	0.004