

Series 1.0/2.3 (50 Ohm/75 Ohm)



Miniature coaxial connectors series 1.0/2.3 (CECC 22230 and IEC 61169-29) coaxial connectors are devised to meet the requirements of compact electronic instrumentation. All plugs and jacks with $Z_0 = 50 \Omega$ are designed for a number of different 50 Ω and 75 Ω cables. Owing to the large demand, the Series 1.0/2.3 has also been optimized as a 75 Ω design into the GHz range. The different types of coupling mechanisms, such as screw on, slide-in and latching coupling permit space-saving installation. In addition, an extensive range of measurement

accessories, adapters as well as terminations is available. The quality-determining factors have been established on the basis of corresponding measurements and test procedures in accordance with national and international standards for RF connectors (IEC 61169-1, MIL-C-39012 etc.). High-quality materials ensure high reliability even in industrial atmospheres. The contact principle is the pin-socket principle and the contacts are gold plated to ensure perfect contact mating. The inner conductor parts are held in PTFE (Polytetrafluoroethylene).

The reduced dimensions of all component parts of these connectors permit a compact hole spacing (installation pitch) of 6.8 [0.27] depending upon the corresponding cable diameters. The cable is connected by crimping the cable braid to the plug or jack body, the inner conductor is soldered or crimped. In most applications, the plug and jack belong to the same coupling type group. In special instances, such as for measurement purposes, different coupling types can be used together.

Between Series Adapters

For Series 1.0/2.3 Adapters please see pages 251-260.

Series 1.0/2.3 (50 Ohm/75 Ohm) (Continued)

Technical Data

Electrical and mechanical characteristics in accordance with CECC 22230

Characteristic impedance —
50 Ω/75 Ω

Frequency range — up to 10 GHz/
2 GHz

Reflection factor, referred to 50 Ω cable¹ —

up to 1 GHz, $r \leq 0.05$
up to 4 GHz, $r \leq 0.07$
up to 10 GHz, $r \leq 0.15$

Reflection factor, referred to 75 Ω cable¹ —

up to 2 GHz, $r \leq 0.10$

Insulation resistance —

initial value $\geq 1 \text{ G}\Omega$
after stressing $\geq 200 \text{ M}\Omega$

Screening effectiveness² —

$\geq 90 \text{ dB}$

Inner conductor contact resistance

— after stressing $\leq 10 \text{ m}\Omega$

Outer conductor continuity —

after stressing $\leq 7.5 \text{ m}\Omega$

Voltage proof³ —

flexible cables (RG 316)
— at sea level, 750 V, 50 Hz
— at 20 km altitude, 150 V, 50 Hz

Working voltage³ —

flexible cables (RG 316)
— at sea level, 350 V, 50 Hz
— at 20 km altitude, 65 V, 50 Hz

Service life — 500 cycles

Climatic category — 40/85/21

Notes:

¹ Guide values, depending on cable type and connector style.

² Values apply to a straight screw and latching coupling with suitable cable.

³ Some cables suitable for use with these connectors have lower characteristic values than specified here.

⁴ For applicable cable types see page 151.

Coupling Types

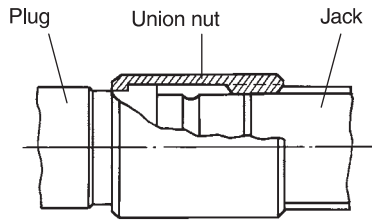

Type A

Screw coupling; version with union nut

This type permits the plug and jack to be screwed together manually by means of a union nut secured to the plug. This is necessary for readily accessible locations, front panel test points and cable connections.

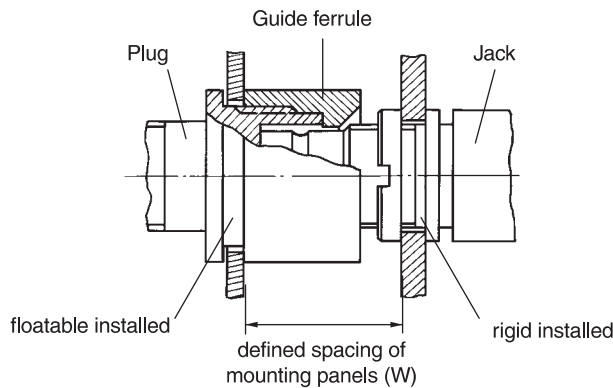

Type C

Slide-in coupling; version with centering ferrule

In this type of coupling, the plug features a guide ferrule with a conical entry surface. This ensures that the floatable bulkhead plugs with cable connection make a reliable electrical connection to the rigid installed jack. Examples of this are single and multi-contact connections of slide-in applications. "W" denotes the allowed spacing of the mounting panel for satisfactory contact when the connection is made.

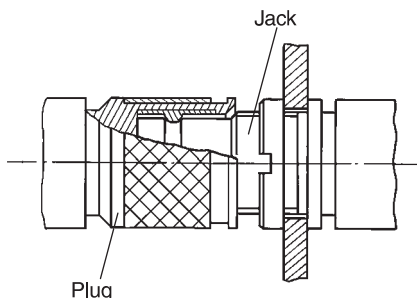

Type F

Latching coupling (Quick Lock)

In this version, the cable plugs bear a funnel ferrule with built-in spring which snaps into a groove on the jack, simultaneously locking the connection. The connec-

tion can be easily separated by lightly pulling the outer sleeve of the plug. This type of coupling can be used with a higher packing density, as the screw coupling.

Series 1.0/2.3, 50 Ohm

Plugs, Solder/Crimp

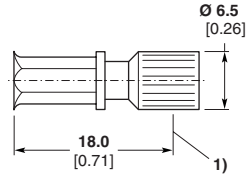

1) Detent for jack

Cable	Coupling Type	Ø Max.	Part No.
RG 316	A	2.67 0.105	1393670-1

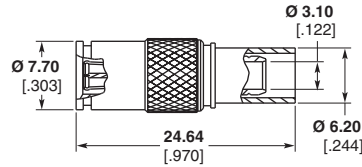

Cable	Coupling Type	Ø Max.	Part No.
WP93385L2	F	2.67 0.105	619223-1

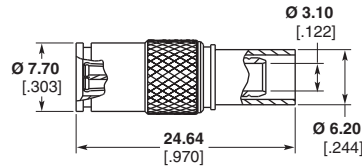

Cable	Coupling Type	Ø Max.	Part No.
LMR 240	F	2.67 0.105	619224-1

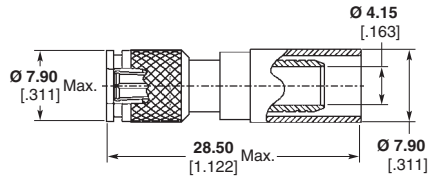

Cable	Coupling Type	Ø Max.	Part No.
LMR 240FR	F	6.3 0.248	1460010-1

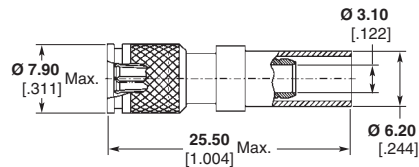

Cable	Coupling Type	Ø Max.	Part No.
WP93385L2	F	6.3 0.248	619085-1

Note: Part Numbers are RoHS compliant except: ♦ Indicates non-RoHS compliant.

Series 1.0/2.3, 50 Ohm (Continued)

**Bulkhead Jack,
Solder/Crimp**

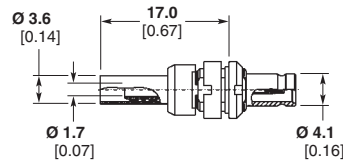

Cable	Coupling Type	Ø Max.	Part No.
RG 316	A, C, F	2.6 0.10	4-1393670-4

Bulkhead Solder Jack

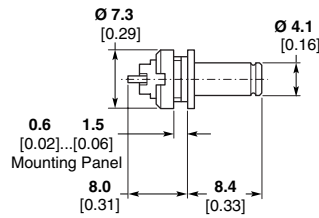

Coupling Type	Part No.
C, F	1393670-8

**Vertical PC Board
Mount Jack**

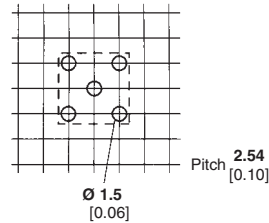
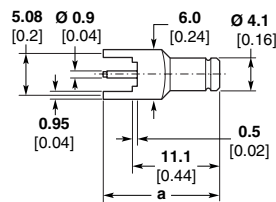

Recommended Mounting Holes

Coupling Type	Dim a	Part No.
C, F	14.6 0.57	3-1393670-4
C, F	15.6 0.61	3-1393670-5

**Vertical PC Board Mount
Bulkhead Jack**

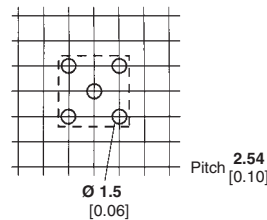
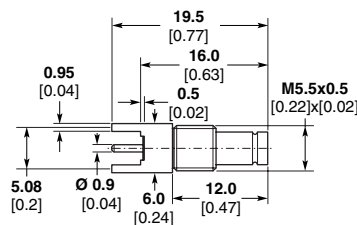

Recommended Mounting Holes

Coupling Type	Part No.
A, C, F	3-1393670-6

Note: Part Numbers are RoHS compliant except: ♦ Indicates non-RoHS compliant.

Series 1.0/2.3, 50 Ohm (Continued)

Right-Angle PC Board Mount Bulkhead Jack

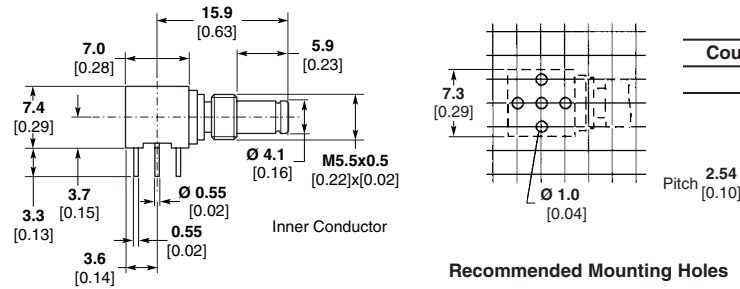

Coupling Type	Part No.
A, C, F	3-1393670-9

Recommended Mounting Holes

Vertical PC Board Mount ACTION PIN Jack

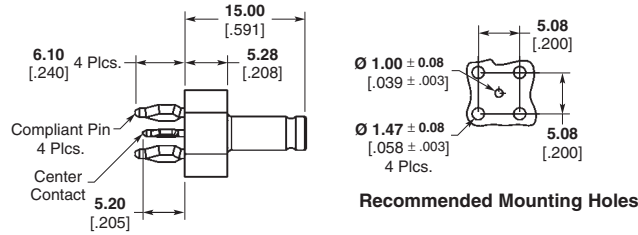

Coupling Type	Part No.
C, F	6274431-1

Recommended Mounting Holes

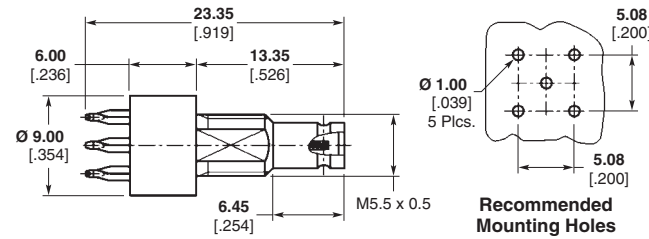

Coupling Type	Part No.
A, C, F	619107-1

Recommended Mounting Holes

Panel Mount, Press-in, Launcher Jack

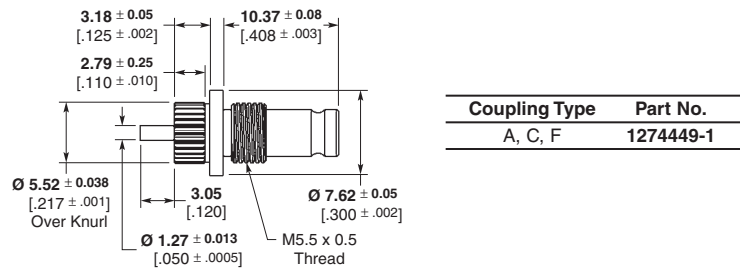

Coupling Type	Part No.
A, C, F	1274449-1

Panel Mount, 4-Hole Flange, Launcher Jack

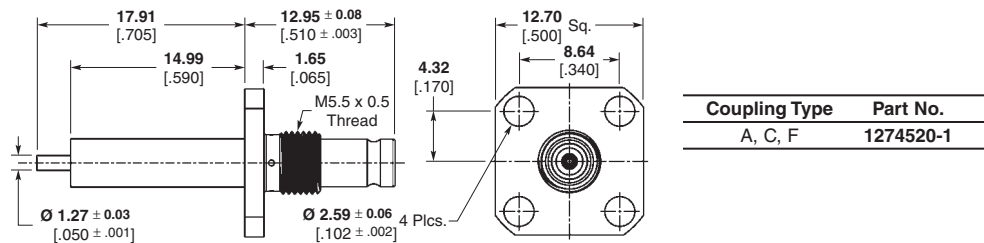

Coupling Type	Part No.
A, C, F	1274520-1

Front Mount, Bulkhead Jack

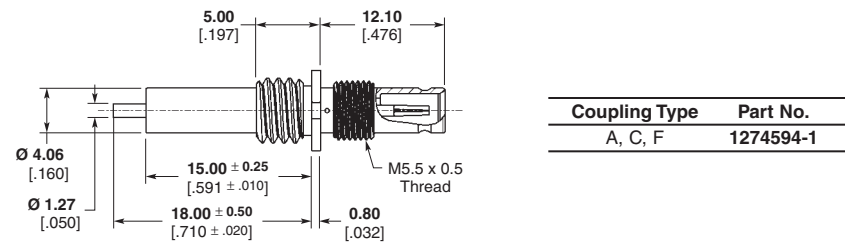

Coupling Type	Part No.
A, C, F	1274594-1

Note: Part Numbers are RoHS compliant except: ♦ Indicates non-RoHS compliant.

Series 1.0/2.3, 50 Ohm (Continued)

**Right-Angle PC Board
Mount Bulkhead Jack**

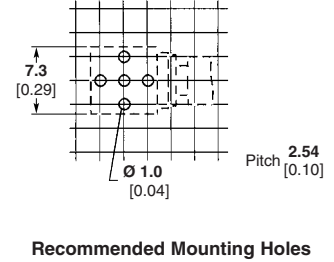
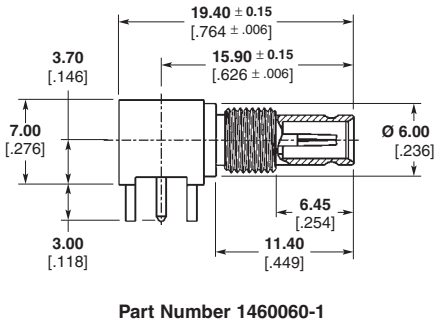
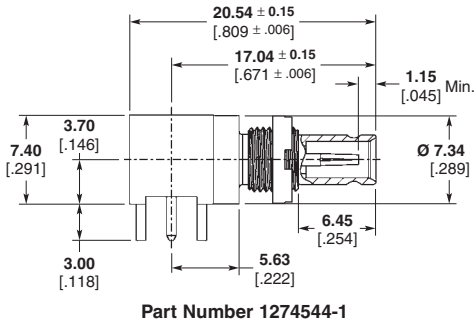

Coupling Type	Part No.
A, C, F	1274544-1
A, C, F	1460060-1

Plating

Outer Body — Silver

Outer and Center Conductor — Gold

Coupling Type	Part No.
A, C, F	1460139-1

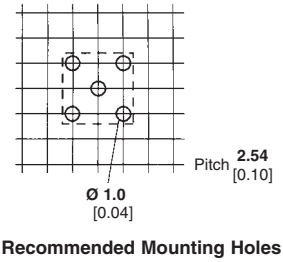
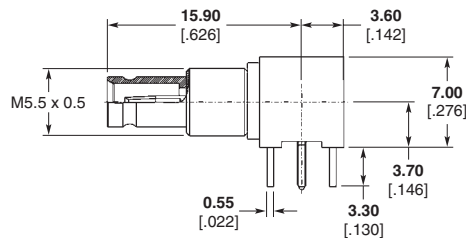

Series 1.0/2.3, 75 Ohm

Plugs, Solder/Crimp

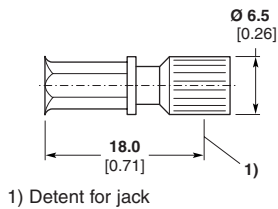

Cable	Coupling Type	Ø Max.	Part No.
RG 179	A	2.67 0.105	5-1393670-5

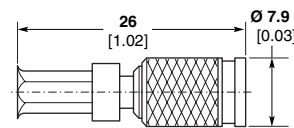

Cable	Coupling Type	Ø Max.	Part No.
RG 179	F	2.67 0.105	6-1393670-2
ST 212	F	3.2 0.13	6-1393670-5
02Y(ST)CY 0.45/2.0	F	3.6 0.14	6-1393670-4

Note: Part Numbers are RoHS compliant except: ♦ Indicates non-RoHS compliant.

Series 1.0/2.3, 75 Ohm (Continued)

**Straight Plugs,
Solder/Crimp**

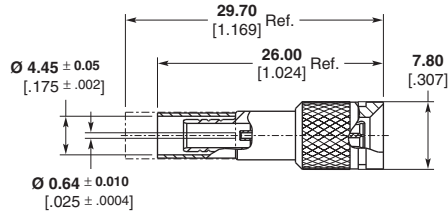

Cable	Coupling Type	Ø Max.	Part No.
BELDEN 1855A	A, C, F	2.67 0.105	619226-1

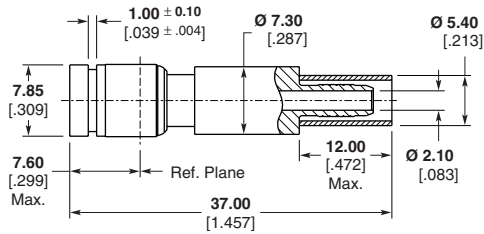

Cable	Coupling Type	Ø Max.	Part No.
BT 3002	A, C, F	2.67 0.105	1460815-1

**Right-Angle Plug,
Solder/Crimp**

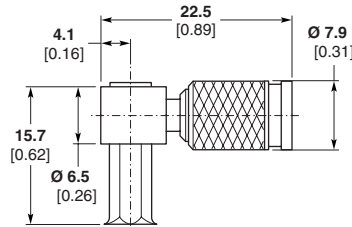

Cable	Coupling Type	Ø Max.	Part No.
RG 179	F	2.67 0.105	2-1393670-6
02Y(St)CY 0.45/2.0	F	3.6 0.14	7-1393670-0

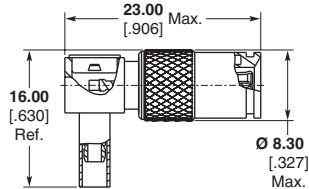

Cable	Coupling Type	Ø Max.	Part No.
RG 316	F	2.8 0.110	619228-1

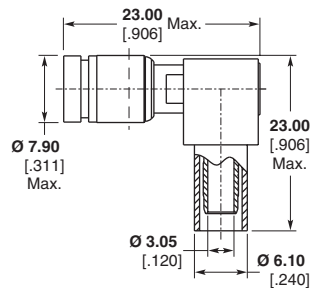

Cable	Coupling Type	Ø Max.	Part No.
RA 7000	A, C, F	2.67 0.105	1460817-1

**Bulkhead Jack,
Solder/Crimp**

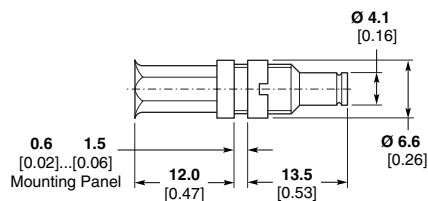

Cable	Coupling Type	Ø Max.	Part No.
RG 179	A, C, F	2.67 0.105	8-1393670-0

BELDEN is a trademark of Belden Wire and Cable Company.

Note: Part Numbers are RoHS compliant except: ♦ Indicates non-RoHS compliant.

Series 1.0/2.3, 75 Ohm (Continued)

Right-Angle Bulkhead Jack, Solder/Crimp

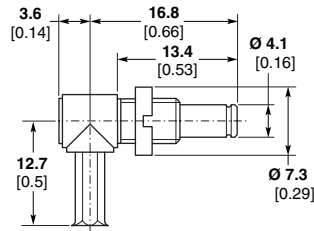

Cable	Coupling Type	Ø Max.	Part No.
RG 179, 316	A, C, F	2.67 0.105	3-1393670-2

Vertical PC Board Mount Bulkhead Jack

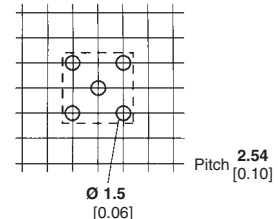
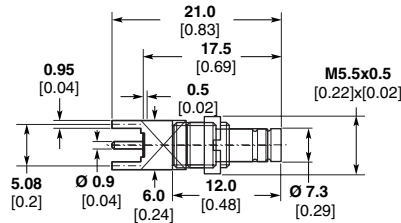

Recommended Mounting Holes

Coupling Type	Part No.
A, C, F	8-1393670-3

PC Board Mount Bulkhead Jack

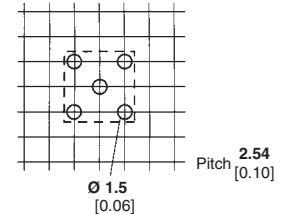
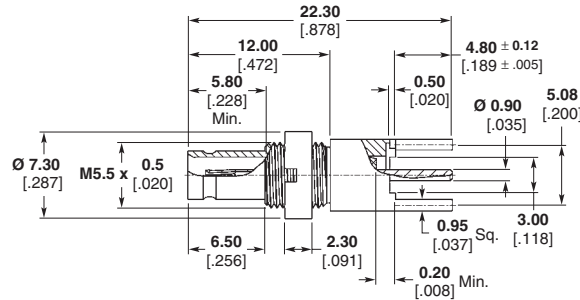

Recommended Mounting Holes

Coupling Type	Ø Max.	Part No.
A, C, F	1.00-2.30 .039-.091	619220-1

Vertical PC Board Mount Bulkhead Jack

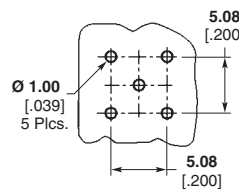
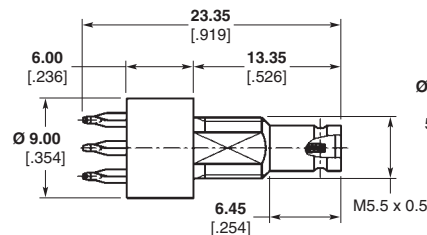

Recommended Mounting Holes

Coupling Type	Part No.
A, C, F	619106-1

Note: Part Numbers are RoHS compliant except: ♦ Indicates non-RoHS compliant.

Series 1.0/2.3, 75 Ohm (Continued)

**Straight PCB Jacks,
Multi-Port**

No. of Ports	Coupling Type	Part No.
2	A, C, F	1274714-3
3	A, C, F	1274714-2
4	A, C, F	1274714-1

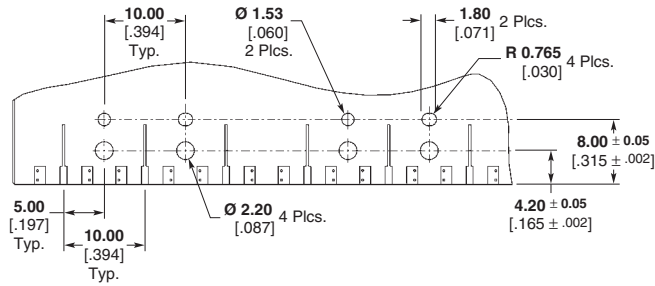
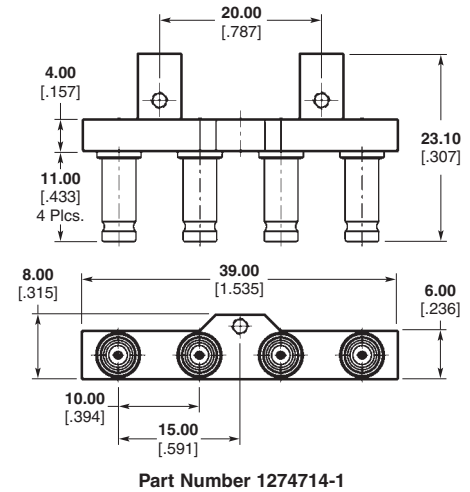
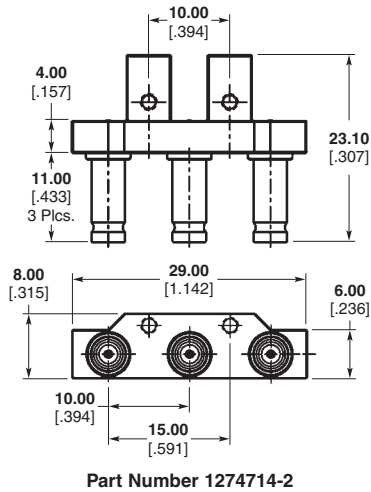
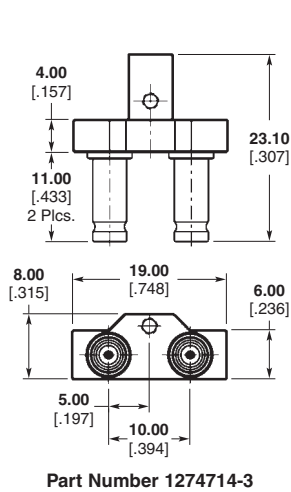

**Recommended PC Board Layout
2 Positions Shown**

**Accessories
for 50 Ohm and 75 Ohm**

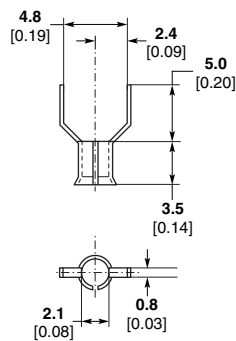

Soldering aid (sleeve) for jack 1393670-8 with solder connection.

Part No.
2-1393562-2

For cable size similar to RG 179 and RG 316

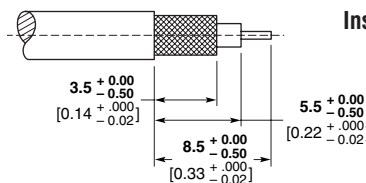

Installation example:

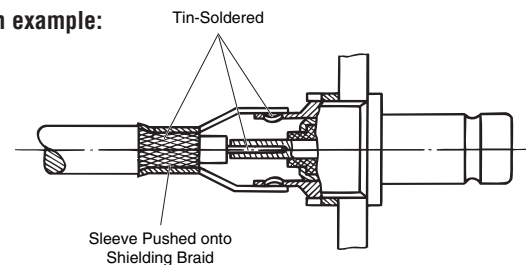

Note: For more accessories, see page 147.

Note: Part Numbers are RoHS compliant except: ♦ Indicates non-RoHS compliant.

Series 1.6/5.6 mS (75 Ohm)



General

The Series 1.6/5.6 mS connectors have been modified to incorporate improved technical advantages. Transmission values have been greatly improved while maintaining the proven positive characteristics of the previous genera-

tions. All types of this new "third generation" Series 1.6/5.6 mS connectors are connection-compatible with their predecessor.

Today's PCM technology demands place the Series 1.6/5.6 mS connectors as a most suitable component for transmission of high bit rates.

Connectors are available in straight and angled versions as well as with different mechanisms for screw (type A), snap-on (type B), slide-in (type C), and latching (type F) coupling. All connectors of different coupling mechanisms are compatible with each other.

Between Series Adapters

For Series 1.6/5.6 Adapters please see pages 253-262.

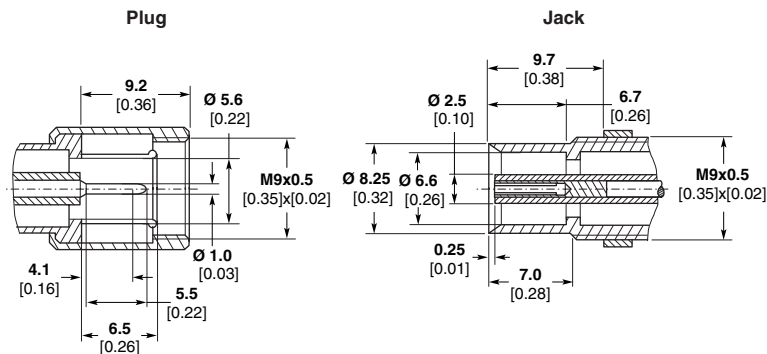

The connectors are designed according to the pin-socket principle. The contacts are partially gold-plated, ensuring long service life and stable contact resistance for a high number of intermateability cycles.

The inner conductor parts are secured so that they cannot be displaced. The insulating parts are made of PEEK (polyetheretherketone) or PC (polycarbonate).

The cable inner conductors are soldered on, while the outer conductors are screwed or crimped on. Also, cable clamp which is independent of the braid clamping secures the connection point against tensile stressing for both methods of connection.

In addition, assembly-friendly connectors with full crimp and IDC (Insulation Displacement Contact) connection are included within

the scope of delivery. The connectors are characterized by high mechanical strength and low space requirement.

Connection possibilities exist for a number of different cables, including highly-flexible cable types (with foam insulation) with low attenuation or small diameter. Terminations and adapters (see also measurement accessories) round out the spectrum.

Series 1.6/5.6 mS (75 Ohm) (Continued)

Technical data

Electrical and mechanical characteristics in accordance with CECC 22240

Characteristic impedance — 75 Ω

Frequency range — up to 8 GHz

Reflection factor¹, referred to —

flexible cables, straight types —

up to 1 GHz, $r \leq 0.02$

up to 4 GHz, $r \leq 0.06$

up to 8 GHz, $r \leq 0.10$

flexible cables, angled types —

up to 1 GHz, $r \leq 0.04$

up to 2 GHz, $r \leq 0.06$

up to 4 GHz, $r \leq 0.10$

Insulation resistance —

initial value, $\geq 10 \text{ G}\Omega$

after stressing, $\geq 1 \text{ G}\Omega$

Screening effectiveness —

(straight screw connector at 1 GHz)

$\geq 100 \text{ dB}$

Inner conductor contact

resistance — after stressing $\leq 8 \text{ m}\Omega$

Outer conductor continuity — after

stressing $\leq 4 \text{ m}\Omega$

Voltage proof² —

flexible cables (RG 59) —

at sea level, 1.5 kV, 50 Hz

at 20 km altitude, 300 V, 50 Hz

Working voltage² —

flexible cables (RG 59) —

at sea level, 500 V, 50 Hz

at 20 km altitude, 125 V, 50 Hz

Service life — 500 cycles

Climatic category — 40/85/21

Notes:

¹ Guideline values, depending on cable type and connector style.

² Some cable types suitable for use with these connectors have lower characteristic values than specified here.

³ For applicable cable types see page 151.

Coupling Types

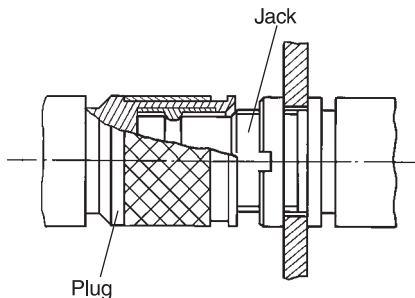
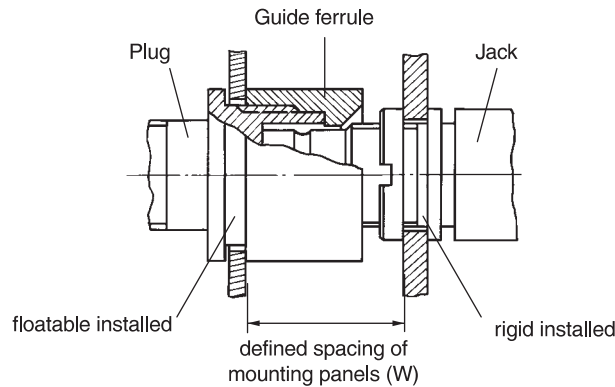
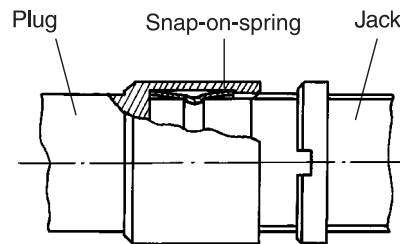
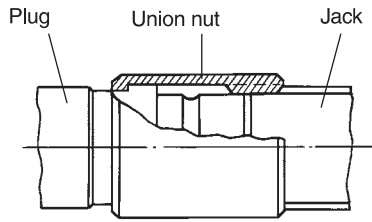

Type A

Screw coupling; version with union nut

This type permits the plug and jack to be screwed together manually by means of a union nut secured to the plug manually, thus preventing the coupling from being pulled apart. This is necessary for readily accessible locations, front panel test points and cable connections.

Type B

Snap-on coupling (push-pull)

Connectors of this type offer fast make/break. They can be used for test and maintenance applications and also if there is lack of space and connectors with screw coupling cannot be used.

Type C

Slide-in coupling; version with centering ferrule

In this type of coupling, the plug features a guide ferrule with a conical entry surface. This ensures that the floatable bulkhead plugs with cable connection make a reliable electrical connection to the rigid installed jack. Examples of this are single and multi-contact connections of slide-in applications. "W" denotes the allowed spacing of the mounting panel for satisfactory contact when the connection is made.

Type F

Latching coupling (Quick Lock)

In this version, the cable plugs bear a funnel ferrule with built-in spring which snaps into a groove on the jack, simultaneously locking the connection. The connec-

tion can be easily separated by lightly pulling the outer sleeve of the plug. This type of coupling provides the same amount of axial tensile strength as the screw coupling, but can be used with a higher packing density.

Series 1.6/5.6 mS (75 Ohm) (Continued)

Plugs, Solder/Clamp

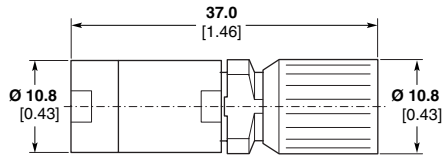

Cable	Coupling Type	Ø Max.	Part No.
2YCCY 0.7/4.4	A	7.8 0.31	1393682-1

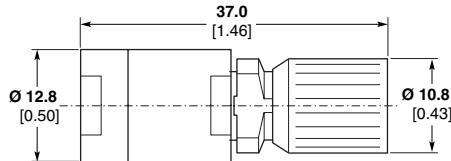

Cable	Coupling Type	Ø Max.	Part No.
2YCCY 1.0/6.5	A	9.8 0.31	1393682-2
2YC(mS)CY 1.0/6.5	A		

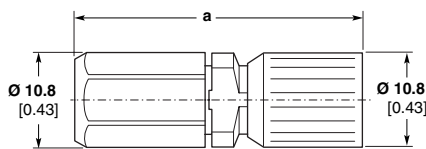

Cable	Coupling Type	Dim. a	Ø Max.	Part No.
2YCY 0.4/2.5	A	30.7 1.21	4.1 0.16	1-1393682-1
2YCCY 0.4/2.5	A	30.7 1.21	4.8 0.19	1-1393682-2
2YC(mS)CY 0.4/2.5	A	30.7 1.21	5.0 0.20	
2YCY 0.7/4.4	A	32.9 1.30	6.1 0.24	1-1393682-3
RG 59	A	32.9 1.30	6.25 0.25	
2YC(mS)CY 0.5/3.0	A	32.9 1.30	6.2 0.24	

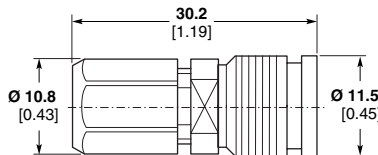

Cable	Coupling Type	Ø Max.	Part No.
02Y(St)CY 0.45/2.0	F	3.6 0.14	1393681-8

Plugs, Solder/Crimp

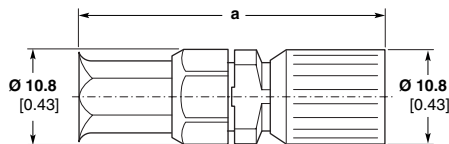

Cable	Coupling Type	Dim. a	Ø Max.	Part No.
RG 179	A	32.5 1.28	2.6 0.105	1393680-2
2YCCY 0.4/2.5	A	32.5 1.28	4.8 0.19	1393680-3
2YC(mS)CY 0.4/2.5	A	35.5 1.40	5.0 0.20	
2YC(mS)CY 0.5/3.0	A	35.5 1.40	6.2 0.24	1393680-4
2YCY 0.7/4.4	A	35.5 1.40	6.1 0.24	1393680-5
02Y(St)CY 0.45/2.0	A	32.5 1.28	3.6 0.14	1393680-9

Note: Part Numbers are RoHS compliant except: ♦ Indicates non-RoHS compliant.

Series 1.6/5.6 mS (75 Ohm)

Plugs, Solder/Crimp
(Continued)

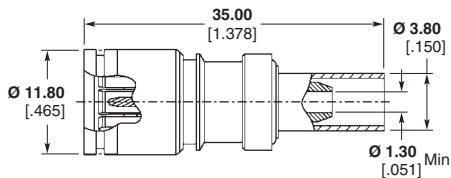
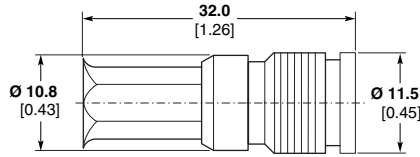
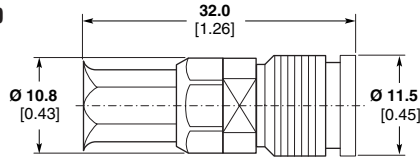

Right-Angle Plugs, Solder/Crimp

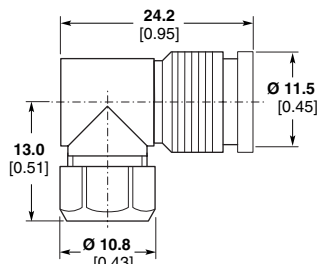
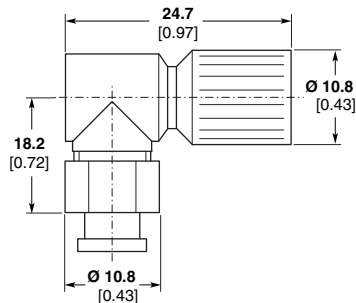
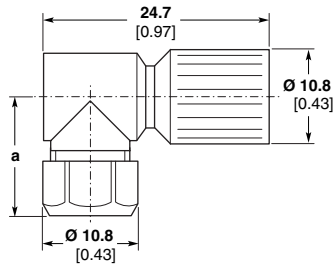

Version with Preassembled Insulation

Cable	Coupling Type	Ø Max.	Part No.
02Y(St)CY 0.45/2.0	F	3.6 0.14	1393672-3

Preassembled Isolation Parts

Cable	Coupling Type	Ø Max.	Part No.
02Y(St)CY 0.45/2.0	F	3.6 0.14	1393672-9

Preassembled Version

Cable	Coupling Type	Ø Max.	Part No.
02YS(St)CHH 0.25/1.2	F	2.9 0.11	1460132-1

Cable	Coupling Type	Dim. a	Ø Max.	Part No.
2YCCY 0.4/2.5	A	13.0 0.51	4.8 0.19	2-1393682-0
2YC(mS)CY 0.4/2.5	A	13.0 0.51	5.0 0.20	
2YCY 0.7/4.4	A	15.8 0.62	6.1 0.24	2-1393682-2
RG 59	A	15.8 0.62	6.25 0.25	
2YC(mS)CY 0.5/3.0	A	15.8 0.62	6.2 0.24	

Cable	Coupling Type	Ø Max.	Part No.
RG 179	A	2.67 0.105	2-1393682-3

Cable	Coupling Type	Ø Max.	Part No.
02Y(St)CY 0.45/2.0	F	3.6 0.14	1-1393681-0

Note: Part Numbers are RoHS compliant except: ♦ Indicates non-RoHS compliant.

Series 1.6/5.6 mS (75 Ohm) (Continued)

**Right-Angle Plugs,
Solder/Crimp**

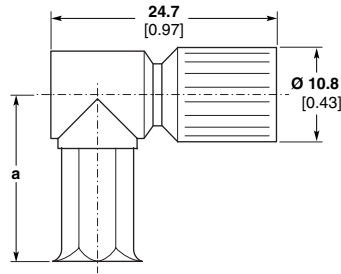

Cable	Coupling Type	Dim. a	Ø Max.	Part No.
02Y12YC(mS)C6Y 0.45/2.0	A	15.0 0.59	4.0 0.16	1-1393680-6
02Y(St)CY 0.45/2.0	A	15.0 0.59	3.6 0.14	1-1393680-8

**Right-Angle Plugs,
IDC Connection**

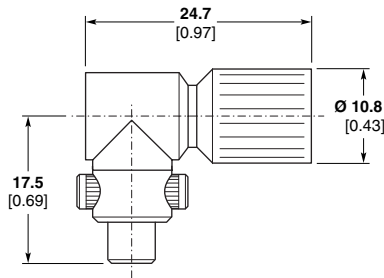

Cable	Coupling Type	Ø Max.	Part No.
02Y(St)CY 0.45/2.0	A	3.6 0.14	1393757-9
2YCY 0.4/2.5	A	4.1 0.16	1393757-8

**Right-Angle Plug,
Solder/Crimp**

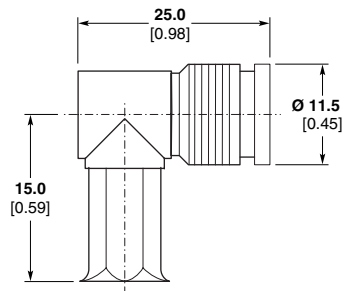

Cable	Coupling Type	Ø Max.	Part No.
02Y(St)CY 0.45/2.0	F	3.6 0.14	1393672-5

**Bulkhead Jacks,
Solder/Clamp**

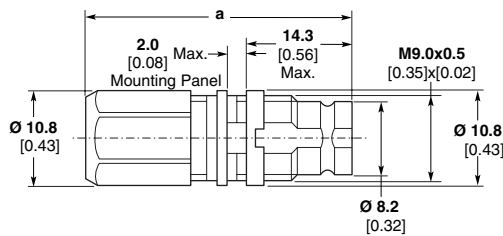

Cable	Coupling Type	Dim. a	Ø Max.	Part No.
2YCY 0.4/2.5	A, B, F	28.1 1.11	4.1 0.16	3-1393682-2
2YCCY 0.4/2.5	A, B, F	28.1 1.11	4.8 0.19	3-1393682-3
2YC(mS)CY 0.4/2.5	A, B, F	28.1 1.11	5.0 0.20	
2YCY 0.7/4.4	A, B, F	30.4 1.20	6.1 0.24	3-1393682-5
RG 59	A, B, F	30.4 1.20	6.25 0.25	
2YC(mS)CY 0.5/3.0	A, B, F	30.4 1.20	6.2 0.24	

Note: Part Numbers are RoHS compliant except: ♦ Indicates non-RoHS compliant.

Series 1.6/5.6 mS (75 Ohm) (Continued)

Bulkhead Jacks, Solder/Clamp (Continued)

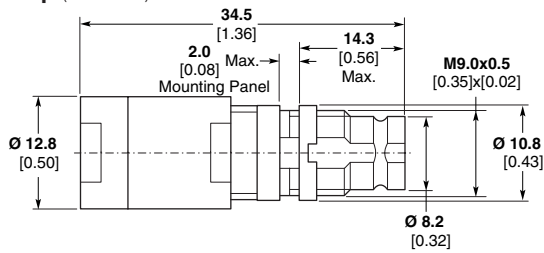

Cable	Coupling Type	Ø Max.	Part No.
2YCCY 1.0/6.5	A, B, F	9.8 0.38	1393682-4
2Y(mS)CY 1.0/6.5	A, B, F	9.8 0.38	

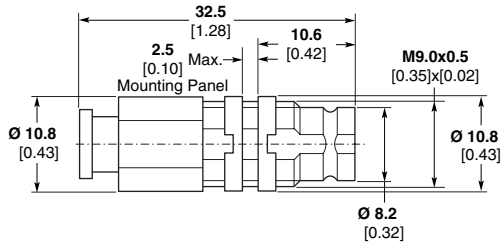

Cable	Coupling Type	Ø Max.	Part No.
RG 179	B, C, F	2.67 0.105	4-1393682-2

Bulkhead Jacks, Solder

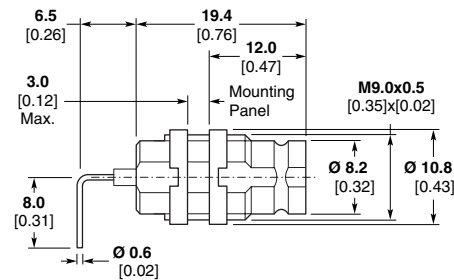
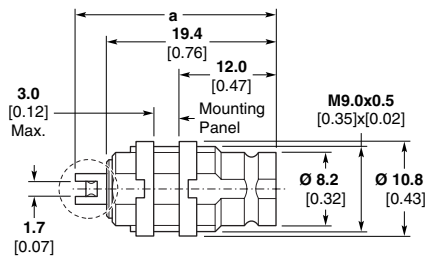

Dim. a	Ø Max.	Part No.
22.3* 0.88	A, B, C, F	1-1393681-1
23.5 0.93	A, B, C, F	1-1393681-9

Coupling Type	Part No.
A, B, C, F	1-1393681-3

*Without soldering tags on outer conductor, dimension a up to inner conductor end.

Bulkhead Jacks, Solder/Crimp

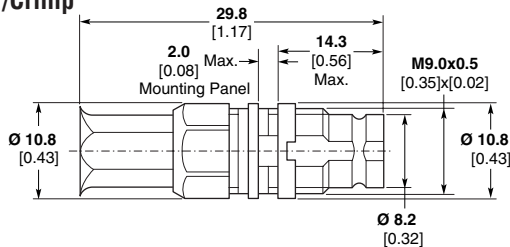

Cable	Coupling Type	Ø Max.	Part No.
RG 179	A, B, F	2.67 0.105	2-1393680-2
02Y12YC(mS)C6Y 0.45/2.0	A, B, F	4.0 0.16	2-1393680-4
06YCC(St)6Y 0.4/1.6	A, B, F	3.3 0.13	2-1393680-5
02Y(St)CY 0.45/2.0	A, B, F	3.6 0.14	1393672-6

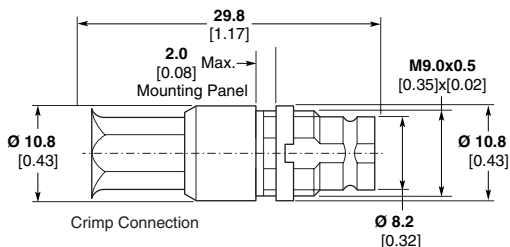

With preassembled insulation parts

Cable	Coupling Type	Ø Max.	Part No.
02Y(St)CY 0.45/2.0	A, B, F	3.6 0.14	1-1393672-4

Note: Part Numbers are RoHS compliant except: ♦ Indicates non-RoHS compliant.

Series 1.6/5.6 mS (75 Ohm) (Continued)

**Right-Angle Bulkhead Jack,
Solder/Clamp**

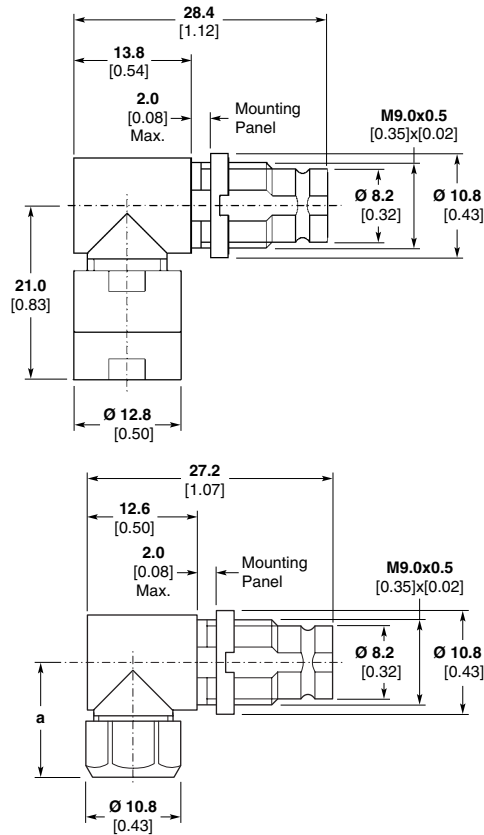

Cable	Coupling Type	Ø Max.	Part No.
2YCCY 1.0/6.5	A, B, F	9.8 0.39	1393682-8
2YC(mS)CY 1.0/6.5	A, B, F	9.8 0.39	

Cable	Coupling Type	Dim. a	Ø Max.	Part No.
02Y(St)CY 0.45/2.0	A, B, F	13.0 0.51	3.6 0.14	4-1393682-9
2YCCY 0.4/2.5	A, B, F	13.0 0.51	4.8 0.19	4-1393682-6
2YC(mS)CY 0.4/2.5	A, B, F	13.0 0.51	5.0 0.20	
2YCY 0.7/4.4	A, B, F	15.8 0.62	6.1 0.24	4-1393682-8
RG 59	A, B, F	15.8 0.62	6.25 0.25	
2YC(mS)CY 0.5/3.0	A, B, F	15.8 0.62	6.2 0.24	

**Right-Angle Bulkhead Jack,
Solder/Crimp**

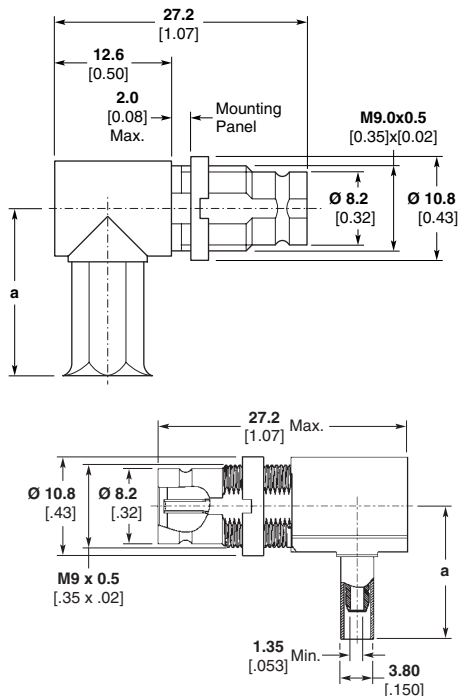

Cable	Coupling Type	Dim. a	Ø Max.	Part No.
RG 179	A, B, F	15.0 0.59	2.67 0.105	3-1393680-0
2YCCY 0.4/2.5	A, B, F	15.0 0.59	4.8 0.19	3-1393680-2
2YC(mS)CY 0.4/2.5	A, B, F	15.0 0.59	5.0 0.20	
02Y12YC(mS)C6Y 0.45/2.0	A, B, F	15.0 0.59	4.0 0.16	3-1393680-5
06YCC(St)6Y 0.4/1.6	A, B, F	15.0 0.59	3.3 0.13	4-1393682-3
02Y(St)CY 0.45/2.0	A, B, F	15.0 0.59	3.6 0.14	3-1393680-7

Cable	Coupling Type	Dim. a	Ø Max.	Part No.
02YS(St)CHH 0.25/1.2	A, B, F	15.0 0.59	2.9 0.11	1460128-1*
02YS(St)CHH 0.25/1.2	A, B, F	15.0 0.59	2.9 0.11	1460169-1**

* Tray Packaging.
** Individual Packaging.

Note: Part Numbers are RoHS compliant except: ♦ Indicates non-RoHS compliant.

Series 1.6/5.6 mS (75 Ohm) (Continued)

**Right-Angle Bulkhead Jack,
IDC Connection**

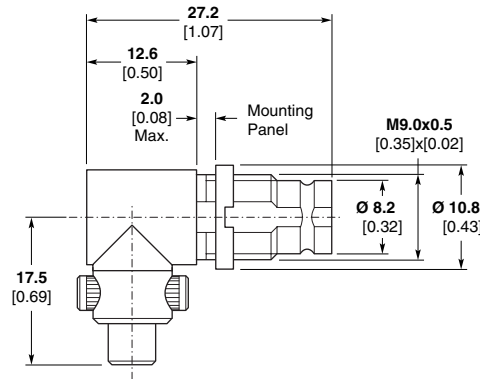

Cable	Coupling Type	Ø Max.	Part No.
02Y(St)CY 0.45/2.0	A, B, F	3.6 0.14	1-1393757-6

**Vertical PC Board
Mount Jack**

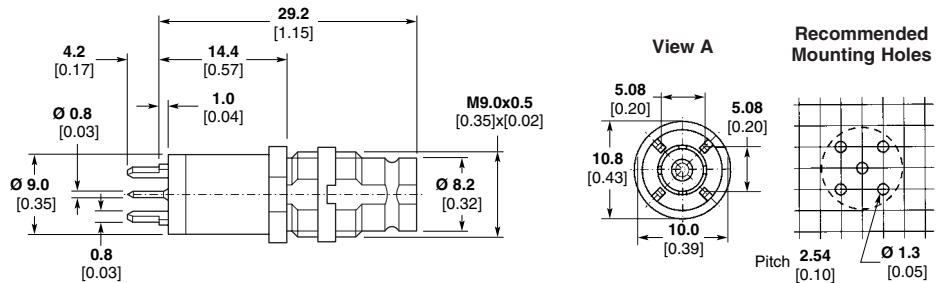

Coupling Type	Part No.
A, B, F	1-1393681-6

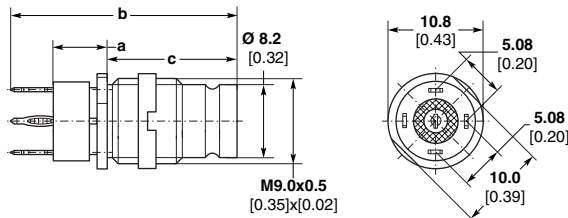

Inner- and outer conductor, press-fit

Coupling Type	Dim. a	Dim. b	Dim. c	Part No.
A, B, F	6.0 0.24	27.2 1.07	16.4 0.65	2-1393757-0

Recommended Mounting Holes

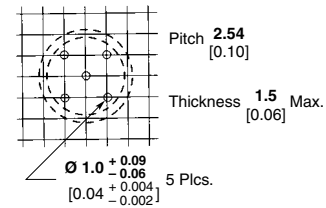

**PC Board Mount
Bulkhead Jack**

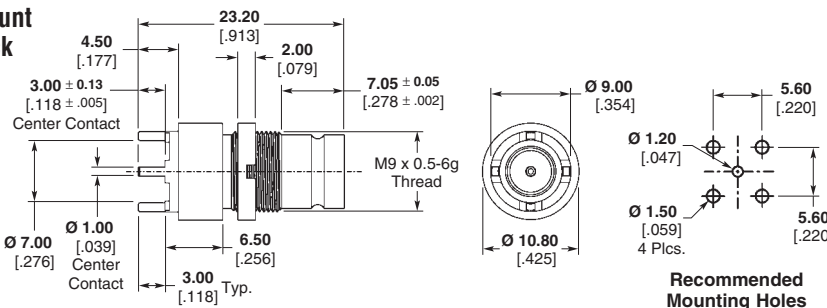

Coupling Type	Part No.
A, B, F	1274513-1

**Recommended
Mounting Holes**

Note: Part Numbers are RoHS compliant except: ♦ Indicates non-RoHS compliant.

Series 1.6/5.6 mS (75 Ohm) (Continued)

Right-Angle PC Board Mount Bulkhead Jack

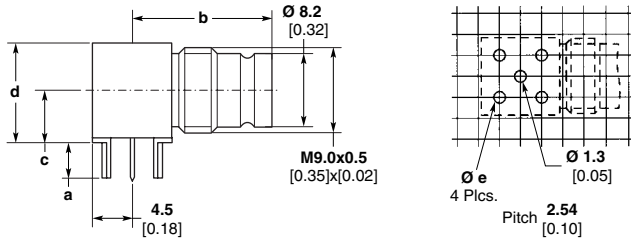

Recommended Mounting Holes

Coupling Type	Dim. a	Dim. b	Dim. c	Dim. d	Dim. e	Part No.
A, B, F	4.0 0.16	16.0 0.63	6.0 0.24	10.75 0.42	1.3 0.05	2-1393681-1
A, B, F	3.3 0.13	16.0 0.63	6.0 0.24	10.75 0.42	1.3 0.05	2-1393681-2
A, B, F	3.7 0.15	22.9 0.90	6.45 0.25	11.25 0.44	1.8 0.07	2-1393681-3*

*With positioning and snap-on system onto PC board

U-link Plug/Plug

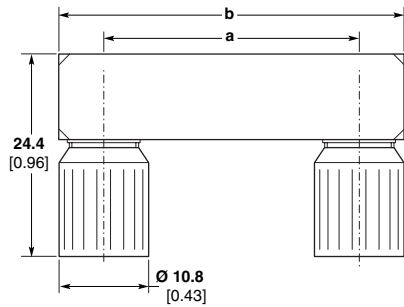

Coupling Type	Dim. a ± 0.1 [0.004]	Dim. b Max.	Part No.
A	15.0 0.59	26.5 1.04	6-1460823-1

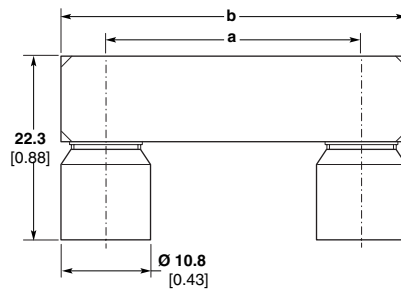

Coupling Type	Dim. a ± 0.1 [0.004]	Dim. b Max.	Part No.
B	15.0 0.59	26.5 1.04	6-1460823-2

Note: Part Numbers are RoHS compliant except: ♦ Indicates non-RoHS compliant.

Series 1.6/5.6 mS (75 Ohm) (Continued)

Accessories

These components are provided when bulkhead jack part numbers are ordered, but can also be ordered separately.

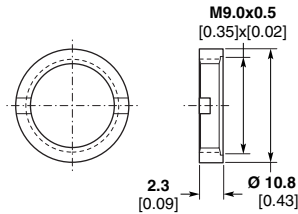

Threaded ring for installation of bulkhead jacks

Part No.
1-1393562-0

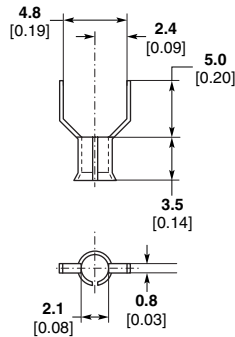

Soldering aid (sleeve) for jack (1-1393681-9) with solder termination

Part No.
2-1393562-2

Cable stripping and installation example: see Part number 2-1393562-2 under "Series 1.0/2.3", page 137.

Measurement Accessories

Between Series Adapters (75 Ohm)

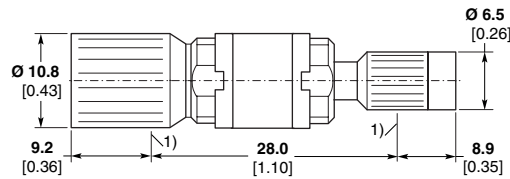

Plug 1.6/5.6 to Plug 1.0/2.3

Coupling Type	Part No.
A	6-1460821-1

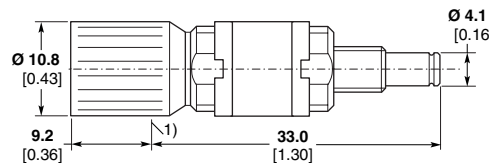

Plug 1.6/5.6 to Jack 1.0/2.3

Coupling Type	Part No.
A, F ²	2-1393670-2 ♦
A, F ²	6-1460821-2

² Only jack side

1) Detent for jack

Note: Part Numbers are RoHS compliant except: ♦ Indicates non-RoHS compliant.

Measurement Accessories (Continued)

Between Series Adapters
(75 Ohm) (Continued)

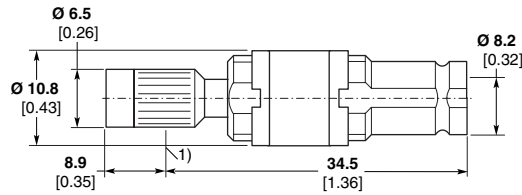

Plug 1.0/2.3 to Jack 1.6/5.6

Coupling Type	Part No.
A, B ² , F ²	6-1460821-3

² Only jack side

1) Detent for jack

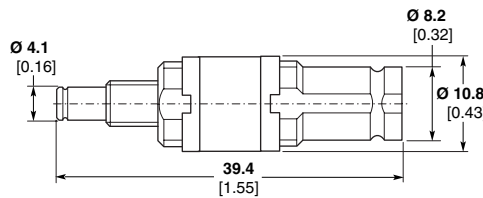

Jack 1.0/2.3 to Jack 1.6/5.6

Coupling Type	Part No.
A, B, F	6-1460821-4

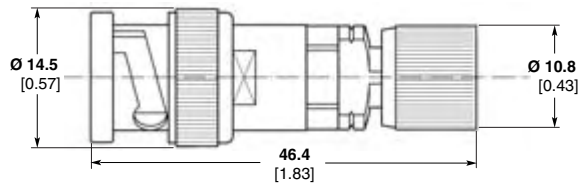

BNC Plug to Plug 1.6/5.6

Part No.
7-1393665-4

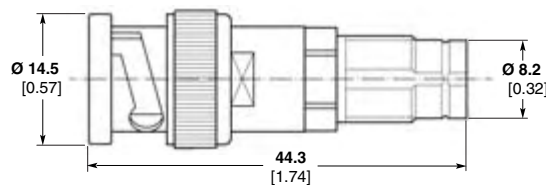

BNC Plug to Jack 1.6/5.6

Part No.
7-1393665-6

Note: Part Numbers are RoHS compliant except: ♦ Indicates non-RoHS compliant.

Measurement Accessories (Continued)

Between Series Adapters
(75 Ohm) (Continued)

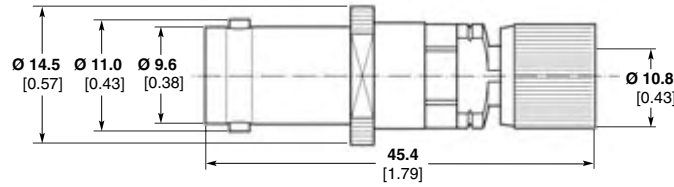

BNC Jack to Plug 1.6/5.6

Part No.
7-1393665-7

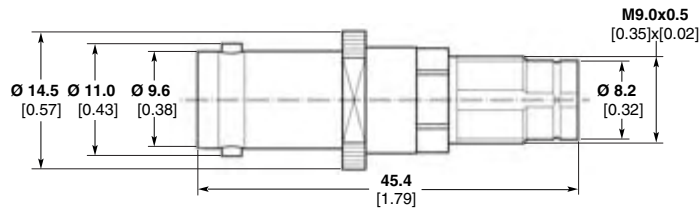

BNC Jack to Jack 1.6/5.6

Part No.
7-1393665-5

Termination (75 Ohm)

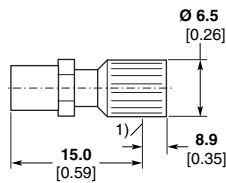

1) Detent for jack

Standard Termination

Plug 1.0/2.3

Coupling Type	Power W	Part No.
A	0.6	7-1393665-2

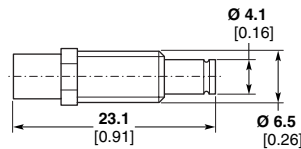

Jack 1.0/2.3

Coupling Type	Power W	Part No.
A, F	0.6	7-1393665-3

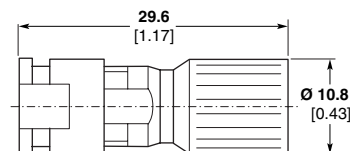

Plug 1.6/5.6

Coupling Type	Power W	Part No.
A	1.0	6-1393665-1

Note: Part Numbers are RoHS compliant except: ♦ Indicates non-RoHS compliant.

Measurement Accessories (Continued)

In-Series Adapter (75 Ohm)

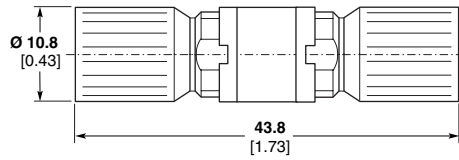

Adapter 1.6/5.6, Plug/Plug

Coupling Type	Part No.
A	1393681-6

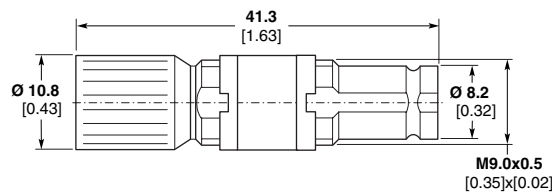

Adapter 1.6/5.6, Plug/Jack

Coupling Type	Part No.
A, B*, F*	1-1393681-7

*Jack side only

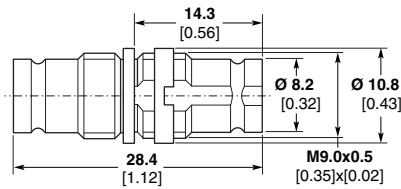

Adapter 1.6/5.6, Jack/Jack

Coupling Type	Part No.
A, B, F	1-1393665-1

Note:

U-link connectors see "1.6/5.6" section, page 146.

Note: Part Numbers are RoHS compliant except: ♦ Indicates non-RoHS compliant.

Coaxial Cables

List of the coaxial cables that are listed in the various connector series of this section.

Characteristic Impedance (Ω)	Max. Cable Outer Diameter (mm)	Dielectric Diameter (mm)/ Material ¹⁾	Cable-Type Designation		
			VDE Designation ²⁾	US Designation Manufacturer des.	IEC Designation 96-IEC
50	1.9	0.91max/PTFE	5YC5Ye 0.3/0.86	RG 178	50-1-1
50	2.1	0.87/PTFE	—	RG 196	50-1-2
50	2.25	1.71max/PTFE	5YK 0.51/1.68	RG 405	—
50	2.6	1.60max/PTFE	5YC5Ye 0.5/1.5	RG 316	50-2-1
50	2.8	1.60max/PE	2YCY 0.5/1.5	RG 174	—
50	3.0	1.52/PTFE	5YCC5Y 0.5/1.5	RD 316	—
50	3.6	3.01max/PTFE	5YK 0.9/3.0	RG 402	—
50	6.4	5.38max/PTFE	5YK 1.63/5.33	RG 401	—
75	2.67	1.68max/PTFE	5YC6Y 0.3/1.6	RG 179	75-2-1
75	3.0	1.60max/PTFE	—	RD 179	—
75	3.3	1.68max/Cell-FEP	06YCC(St)6Y 0.4/1.6	—	—
75	3.2	2.1max	—	ST 212	—
75	3.6	2.0max/Cell-PE	02Y(St)CY 0.45/2.0	—	—
75	4.0	2.0maxE/Cell-PE	02Y12YC(mS)C6Y 0.45/2.0	—	—
75	4.0	2.54max/PE	2YCY 0.4/2.5	—	—
75	4.8	2.54max/PE	2YCCY 0.4/2.5	—	—
75	5.0	2.54max/PE	2YC(mS)CY 0.4/2.5	—	—
75	6.1	4.25max/PE	2YCY 0.7/4.4	—	—
75	6.2	2.83max/PE	2YC(mS)CY 0.5/3.0	—	—
75	6.25	3.8max/PE	2YCY 0.58/3.7	RG 59	—
75	7.8	4.43max/PE	2YCCY 0.7/4.4	—	—
75	9.8	6.4/PE	2YCCY 1.0/6.5	—	—
75	9.8	6.4/PE	2YC(mS)CY 1.0/6.5	—	—

1) Material label

- PTFE Polytetrafluorethylene
- PE Polyethylene
- FEP Perfluorethylene propylene
- PFA Perfluoralkoxy copolymer

2) Mounting label of the VDE type numbers (from inside to outside)

Example:

Explanation

Dielectric and Jacket
 2Y = PE
 5Y = PTFE
 02Y = Cell PE
 06Y = Cell FEP
 6Y = FEP

Screen:
 C = Cu braiding
 K = Cu tape
 Intermediate layer:
 mS = magnetic screen
 St = static screen

Specifications on inner conductor:
 vs = silver plated
 staku = Bare copper-clad steel wire conductor

Jacket color:
 gn = green
 gr = grey
 rt = red
 ws = white

